

THE 3D X-RAY FAMILY



SIRONA.COM

The Dental Company

sirona.

AS VERSATILE AS PRACTICE LIFE.

The Sirona 3D x-ray family offers 3 units, GALILEOS Comfort^{PLUS}, ORTHOPHOS SL 3D and ORTHOPHOS XG 3D, whose visual possibilities cover the entire range of all specializations in dentistry. Which unit is the one for you and your practice? You will find out! **Enjoy every day. With Sirona.**



THE THIRD DIMENSION MAKES THE DIFFERENCE.

More precise diagnoses, clearer explanations: 3D imaging has many benefits. Be it overlaid teeth, unexpected nerve channel paths, concealed roots, or temporomandibular joint anomalies, 3D images are of inestimable value in a large number of diagnoses.

- 3D imaging increases your own diagnostic accuracy
- Better inclusion of the patients in planning
- No referral of your patients to specialists
- These units increase your practice services and your success

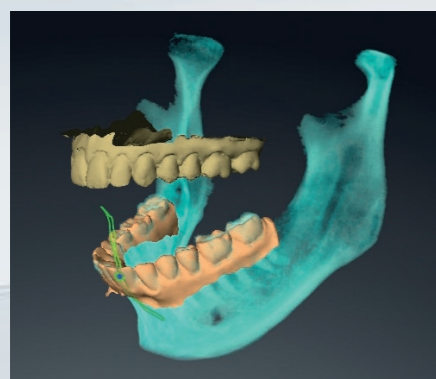

From implantology and endodontics to functional treatment – 3D imaging broadens your diagnostic abilities and makes you more certain in special cases.

WORK QUICKLY, PRECISELY AND RELIABLY.

Sirona imaging units stand out for their simple operation and positioning, thus providing efficient workflows. The unprecedented image quality allows extremely precise diagnosis and planning. With Sirona, you trust a global brand with hundreds of thousands of units in practice distinguished by their MADE IN GERMANY quality.

OPTIMUM
WORKFLOW

UNPARALLELED
IMAGE QUALITY

PROVEN
SOLUTION



FLEXIBILITY AND RELIABILITY WITH A LOW DOSE.

The Sirona 3D x-ray family combines high resolution image quality with great flexibility. Simply choose the best volume for your practice – this can be easily adjusted for the individual patient situation and will support your diagnosis with clear, sharp images with the lowest dose.



AN OVERVIEW OF THE VOLUMES AVAILABLE IN THE SIRONA 3D FAMILY:

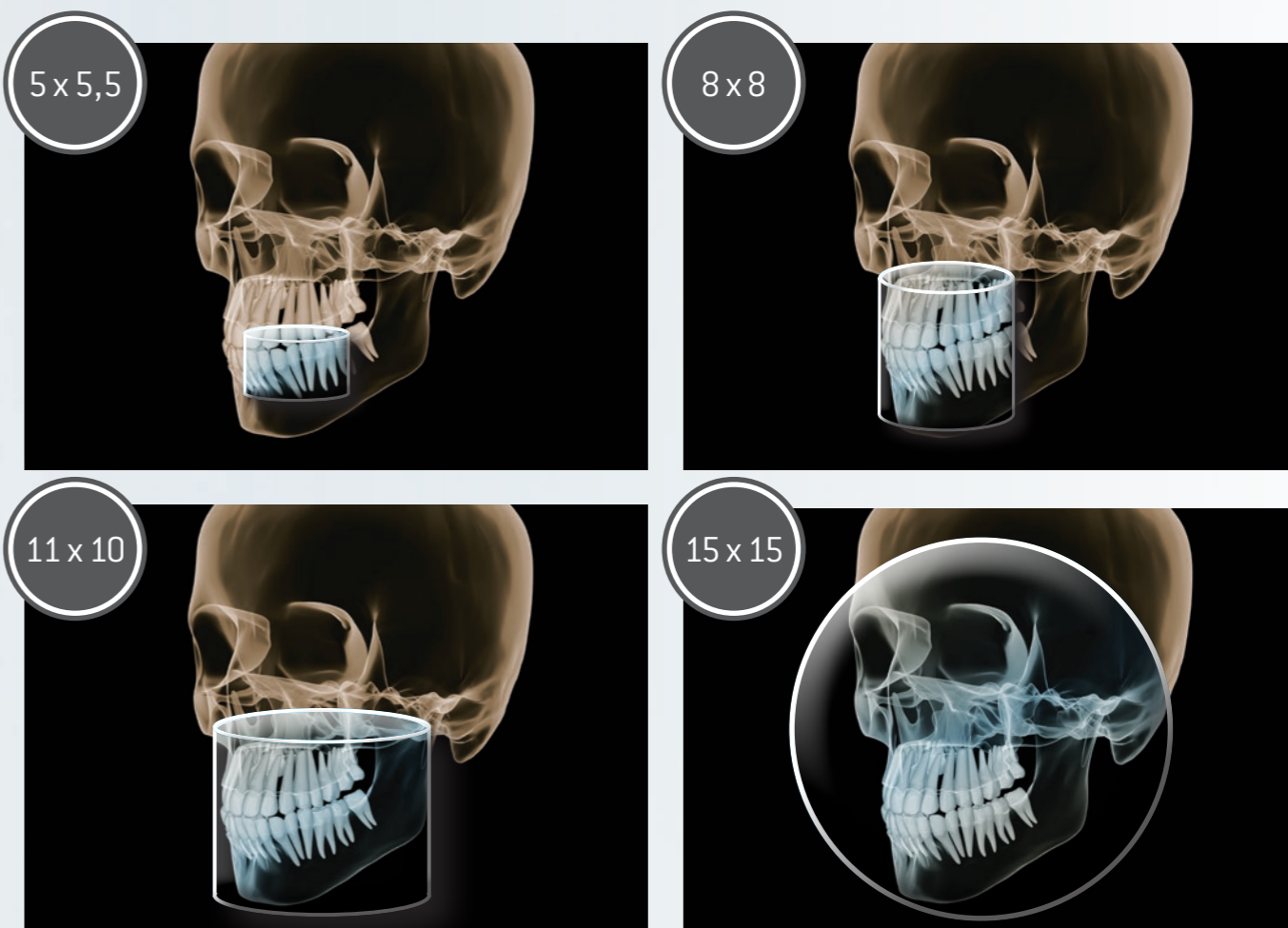

Other available volumes (varies according to the unit):
8 cm x 5.5 cm; 11 cm x 8 cm; 11 cm x 7.5 cm upper jaw; 15 cm x 8.5 cm upper jaw; 15 cm x 8.5 cm lower jaw

MORE POSSIBILITIES FOR YOUR PRACTICE



The best image quality for all areas of use: In order for you to be perfectly ready for every case, the Sirona 3D x-ray family naturally offers outstanding solutions for both approaches, 2D and 3D.

EASY OPERATION, SAFE POSITIONING.

Sirona offers unique patented solutions for operating the units and positioning the patients. Optimize your practice workflow with intuitive user interfaces and automatic positioning aids that eliminate unnecessary corrective scans and waiting times.



Intuitive operation

No matter how your X-ray room is set up – the swiveling and tilting EasyPad makes it highly flexible and the clearly arranged buttons and symbols ensure optimum operation.



The patented occlusal bite block

Position the patient with the patented occlusal bite block. The unit automatically determines the correct tilt of the head and indicates it using corresponding symbols and colors – all you need to do is press the up and down arrows.



Stable positioning for high-quality images

Stable patient positioning prevents motion blurring. The motorized 3-point head fixation and stable handles give your patients the necessary support. At the same time, the EVI* light localizers show you the patient's position in the volume. The integrated temple width measurement ensures an orbit specific to each patient and thereby results in high image sharpness.

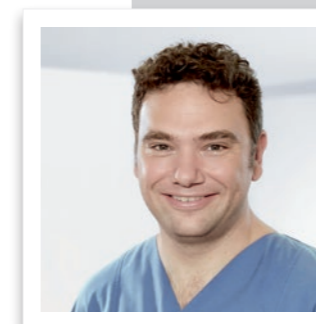

PD Dr. Dr. Lutz Ritter,
Oral and Maxillofacial
Surgery, Hennef

"THE NEW POSITIONING TOOLS MAKE FOR GOOD IMAGING."

"Positioning with the ORTHOPHOS SL is very easy for our team. The many aids such as automatic light localizers, illuminated height adjustment buttons and intuitive program selection allow us to work efficiently with very good image quality. In combination with SIDEXIS 4, we have a comprehensive package that gives us absolute confidence in the findings."

* EVI = Easy Volume Indicator.

WORKING DIGITALLY IS THIS EASY.

SIDEXIS 4 – this is the core of the digital workflow with Sirona.

The software with its intuitive user interface has a very simple structure: it follows the clear structure of your work processes and provides you at all times with all visual data of your patients seamlessly and at a glance – whether 2D, 3D or intraoral. This integrates your patients optimally and thus results in a high acceptance of your treatment proposal. SIDEXIS 4 stands for real imaging efficiency.



Simple overview of the patient history

The timeline gives us a quick overview of the entire history of the patient. This allows you to add a time dimension to your diagnostic options in a very intuitive way.

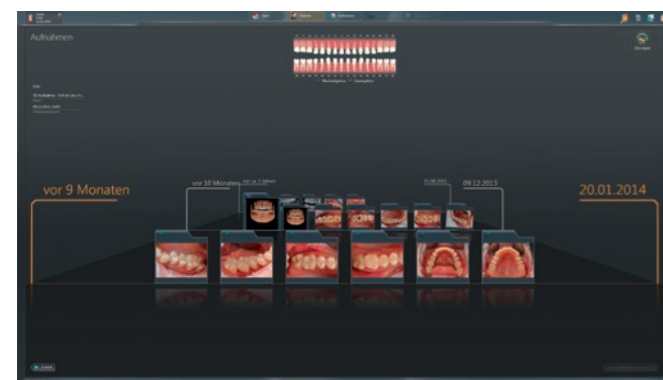

Compare images directly

Ideal for a comprehensive diagnosis: In the lightbox, 2D and 3D images as well as camera images and facescan data can be compared side-by-side.

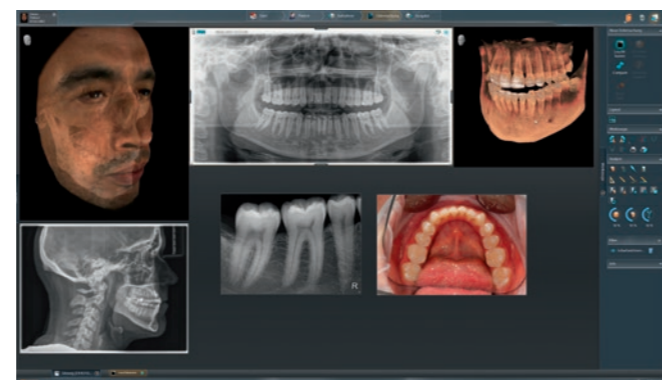

Clear and understandable workflows

The software structure with easy-to-understand symbols makes it simple to use. It is geared to your practice workflows and it helps the entire practice team to use the software intuitively.

- Modern design
- Software platform for all Sirona x-ray units
- Intuitive operation, optimally coordinated workflows
- Simple overview of the patient history thanks to the intuitive timeline
- Easy export of DICOM data sets
- Interface of the integrated solutions from Sirona

THE SIMPLE WAY TO A COMPLETED IMPLANT.

Software and hardware perfectly coordinated – that is Sirona quality in implantation. With the support of the GALILEOS Implant software, prosthetic suggestions from the CEREC software can be combined with your 3D X-ray data. In this way you can enjoy absolute certainty in an efficient, time-saving workflow. And your patients can look forward to perfect results with fewer treatment sessions.



SCAN



In the first step, all of the necessary images for planning are prepared: Intraoral impressions for the prosthesis – 3D X-ray images for surgical planning.

PLAN



The prosthetic suggestion and the X-ray data are combined in the software. On the basis of this combination, implant planning and the completion of the appropriate surgical guide follow.

PLACE



Next, the implant is inserted securely and in an uncomplicated fashion using the surgical guide, which allows minimally invasive work. With CEREC Guide 2, Sirona has the most convenient and quickest in-house surgical guide in the world.

RESTORE



In the final step, you plan the abutment and crown with the CEREC 4.4 software, which you then produce quickly and very precisely in your own practice with CEREC MC X or the MC XL Premium package. The crown is precisely fitted and this is monitored with intraoral sensors.

1ST SESSION

WITH SIRONA



CEREC AC with CEREC Omnicam and CEREC Bluecam

GALILEOS, ORTHOPHOS SL 3D or ORTHOPHOS XG 3D



GALILEOS Implant software

2ND SESSION



CEREC Guide 2

SICAT OPTIGUIDE

3RD SESSION*

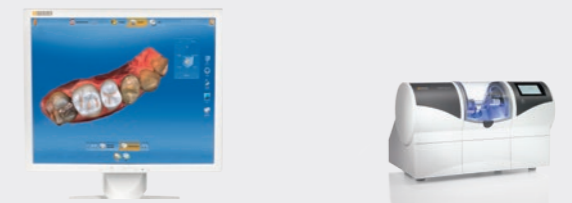

CEREC Software 4.4

CEREC MC XL milling unit Premium Package

*Applies to immediately resilient implants

UNIQUE POSSIBILITIES.

In addition to integrated implantology, SIDEXIS 4 integrates many other time-saving and convenient software solutions. For example, the SICAT Function offers a simple workflow for functional diagnosis and therapy. For the first time, a 3D solution is available that allows analysis and treatment of obstructive sleep apnea in a purely digital workflow thanks to the new SICAT Air software.

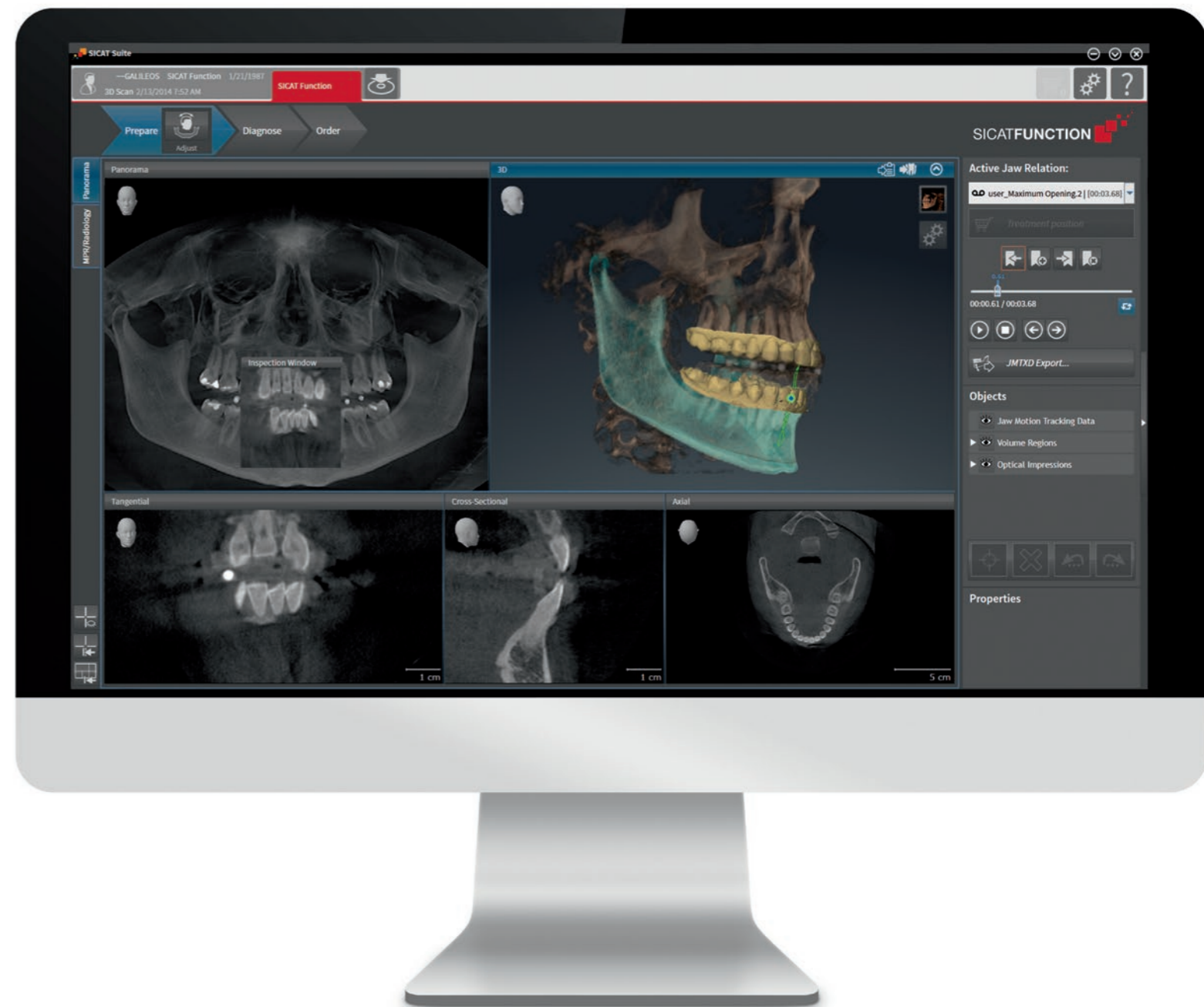

SICAT Air and SICAT OPTISLEEP

After analysis of the upper airway in 3D, SICAT Air gives a report on the effect of the planned protrusion degree and possible effects on the temporomandibular joint. Ordering an individual patient therapeutic appliance with OPTISLEEP is done purely digitally.

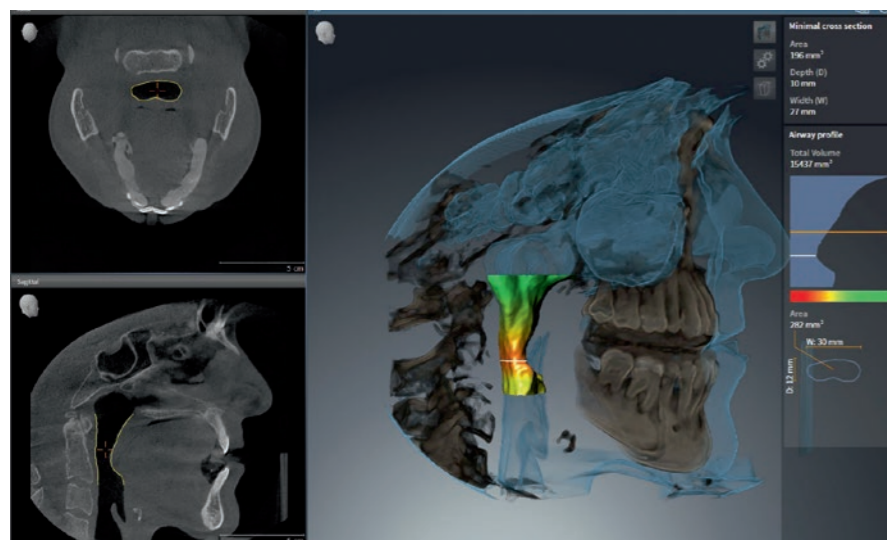

SICAT Function

For the first time, SICAT Function gives an anatomically correct view of the movement of the lower jaw of the individual patient in the 3D volume. Movement of the mandibular joint can be visualized for each point in the 3D volume.

SICAT Function with CEREC

In combination with CEREC, you receive the actual articulation in CAD/CAM. The advantages: functional prosthetics with reduced grinding effort and implementation of new treatments.

SICAT OPTIMOTION

SICAT OPTIMOTION is the world's first CMD therapeutic appliance that implements both the individual patient movements and the pure condyle-fossa relationship in the therapeutic appliance. Depending on the preference, the SICAT OPTIMOTION is completed purely digitally with SICAT.



EXPERIENCE YOU CAN RELY ON.

Around the world, over 100,000 extraoral imaging units from Sirona have been installed in practices. They impress their users with their high German quality standards proverbial reliability in use, and ease of operation. Reliable after-sales support and topical product training provide additional peace of mind.



Sirona is a pioneer in the field of imaging. We have been establishing new methods for 120 years – but only when they really do provide a simpler solution to challenges and allow you to work faster, more safely and more economically – and all to the benefit of the patients. The ideas that our 200+ developers are pursuing are becoming products, on which you can absolutely rely in everyday practice thanks to our extensive experience.

You notice it when you work with a Sirona 3D x-ray unit. The workmanship is first-class – even Made in Germany. If you choose Sirona, you choose a solution built on viable, sustainable products that represent a first-class technological solution not only today, but in the future time and again.



"Made in Germany" quality and future viability: At the Center of Innovation in Bensheim, Germany, Sirona products are developed for the highest demands.



WHICH UNIT IS THE ONE FOR YOU?

Frequency and type of use, specialization, price, and personal preferences – every dental practice has its own requirements for an X-ray unit. Here is a quick overview of which Sirona 3D X-ray unit is right for you.

WHICH UNIT IS THE ONE FOR YOU?

Unit	ORTHOPHOS XG 3D	ORTHOPHOS SL 3D	GALILEOS Comfort ^{PLUS}
General dentists	■	■	–
Orthodontic practice	■	■	■
Implanting dentist	■	■	–
Implantology practice	–	■ ORTHOPHOS SL 3D 11 x 10 cm	■
Oral and maxillofacial surgery	–	■ ORTHOPHOS SL 3D 11 x 10 cm	■
Radiology center	–	■ ORTHOPHOS SL 3D 11 x 10 cm	■
ENT practice	–	■ ORTHOPHOS SL 3D 11 x 10 cm	■
Functional diagnosis	–	–	■

■ Suitable.



EXACTLY WHAT YOU NEED.

You will quickly find out which 3D X-ray unit fits best in your daily routine. GALILEOS Comfort^{PLUS}, ORTHOPHOS SL 3D or ORTHOPHOS XG 3D – high-volume DVT or hybrid unit: All units offer you many possibilities and can be integrated perfectly into your practice.

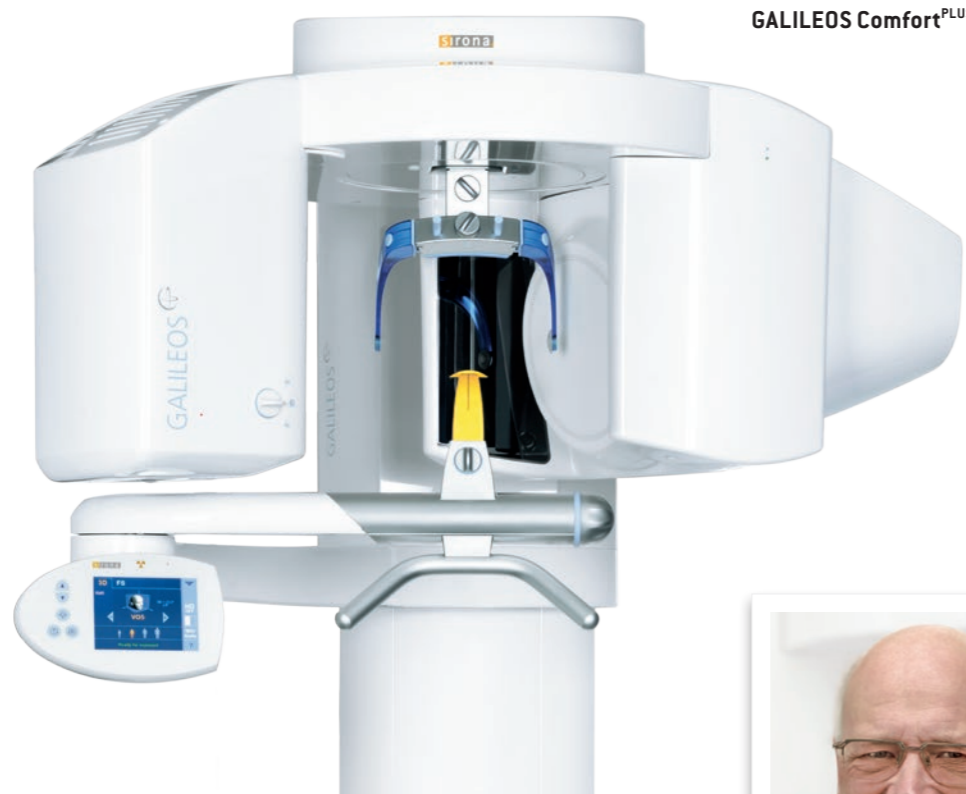

GALILEOS Comfort^{PLUS}

"GALILEOS AND I MAKE A SUPER TEAM."

"Its simple and time-saving operation means that it fits in very well in my practice routine and its great volume covers all relevant problem areas. Thanks to the great image quality and the 3D volume, I can give my patients the best possible advice. Without my GALILEOS, I would not be as successful today."

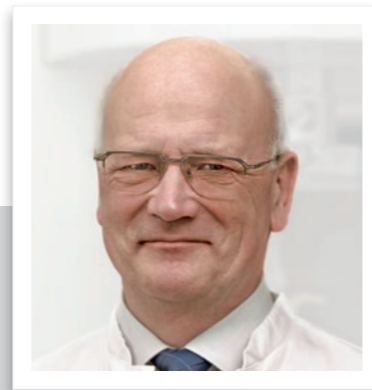

Dr. Dr. Dieter Hültenschmidt, Maxillofacial Surgery, Karlsruhe



ORTHOPHOS SL 3D

"THE ALL-ROUNDER FOR DIAGNOSTICS"

"It is not only because of my interest in technology that I find the combination of direct conversion technology and the reconstructive sharp layer procedure in the ORTHOPHOS SL to be truly exciting. The resulting precise images work perfectly for interpretation. In combination with the volume selection in 3D, we have a universally applicable diagnostic partner for our practice."



Marcin Wojtunik, Specialist in oral surgery, Pfronten



Dr. Björn Ludwig, orthodontist, Traben-Trarbach

"INDIVIDUALIZED X-RAY DIAGNOSIS WITH REDUCED RADIATION IS IMPORTANT TO ME."

"As an orthodontist, I treat patients of all ages, whose treatment presents all kinds of x-ray requirements. The ORTHOPHOS XG 3D helps me with its variety of programs and possibilities for reducing radiation from 2D to 3D – for me, this is individual and practical x-ray technology."

ORTHOPHOS XG 3D



GALILEOS Comfort^{PLUS}

A magnificent 3D X-ray unit that is characterized by reliable results and has absolute flexibility, the simplest operation, and high resolution image quality.

A magnificent 3D X-ray unit that is characterized by reliable results, absolute flexibility, the simplest operation, and high resolution image quality. The GALILEOS Comfort^{PLUS} combines this total package to meet the highest of demands with an extremely low dose and unparalleled reliability. At the same time the optionally integrated Facescanner offers every practice extremely up-to-date patient advice.

It does not matter how your X-ray room is set up – the swiveling and tilting EasyPad guarantees you excellent and simple operation due to the easily visible setup of the buttons and symbols. That is why the 3D X-ray unit GALILEOS Comfort^{PLUS}, which has received the Townie award twice in a row (2013 and 2014), can be recommended to dentists.



Integrated Facescanner

While taking the X-ray image, the optionally integrated Facescanner plots the patient's facial surface. This realistic illustration makes your treatment suggestions for patients more understandable and builds confidence in your expertise.



Integrated implantology

Integrated implantology reduces the number of sessions required to achieve a completed implant. With the GALILEOS implant software, you can combine the prosthetic suggestion from CEREC with the 3D X-ray data in order to make a simple plan for the implant.

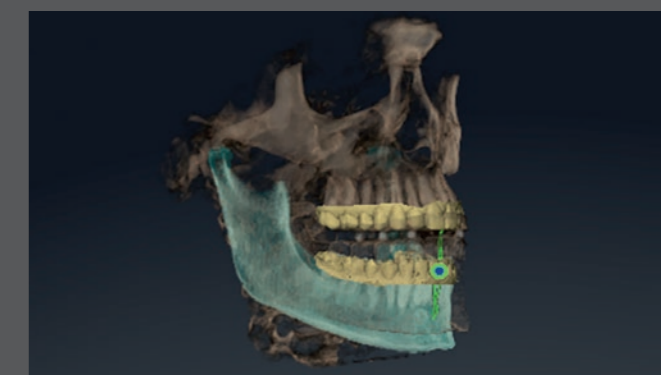

SICAT Function

For the first time, the software for diagnosis and treatment of cranial mandibular dysfunctions gives an anatomically correct view of the the individual patient movement of the lower jaw in the 3D volume.

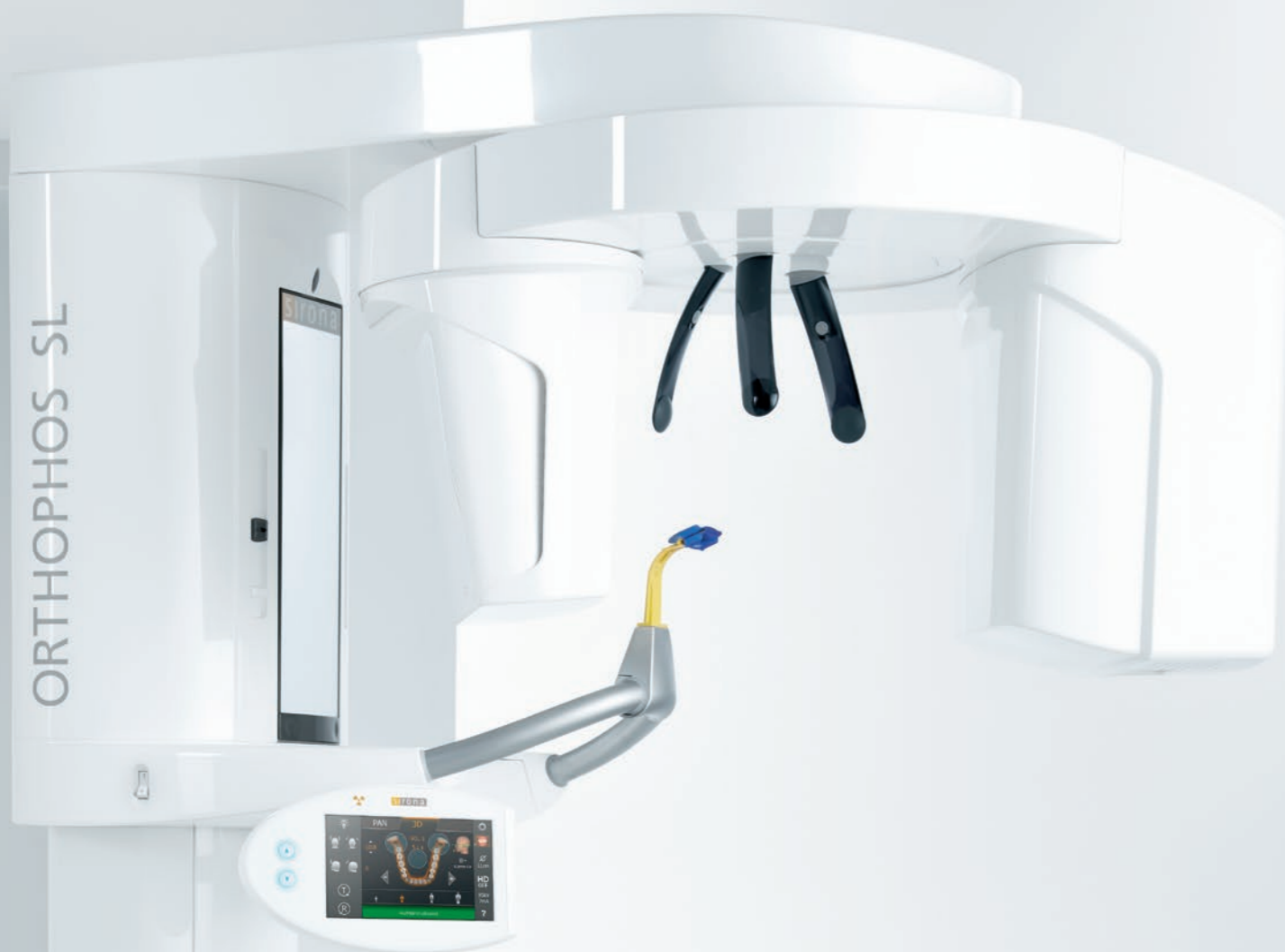

ORTHOPHOS SL 3D

ORTHOPHOS SL is the latest member of the successful Sirona 3D imaging family. It wins points for functionality, quality and design.

With the ORTHOPHOS SL, your practice is extremely well prepared for various treatment situations. On the 2D side, the groundbreaking DCS sensor and SL technology satisfy the requirements of dentists with very high demands for panoramic imaging. In 3D, the choice is between the 11 cm x 10 cm volume, which gives an image of the complete tooth structure, including extraordinary situations, and the 8 cm x 8 cm volume for generalists and implanting dentists.

The ceph arm provides detailed, high-contrast cephalometric images perfectly suited for orthodontic analyses and tracings.

In combination with the pioneering SIDEXIS 4 software, the ORTHOPHOS SL offers a variety of innovative solutions for the practice workflow.

Patients appreciate the soothing Ambient Light, which offers a choice of over 30 colors for a pleasant atmosphere in your X-ray room that fits perfectly into the look of your practice.

3D - NOW OR LATER

If 3D X-ray does not yet fit into your practice concept today, with ORTHOPHOS SL 2D from Sirona you can still switch to the third dimension later on. The unit can be equipped with a 3D module (up to 11 cm x 10 cm) and thus can be upgraded to an ORTHOPHOS SL 3D.



OPTIONS FOR ALL PRACTICES

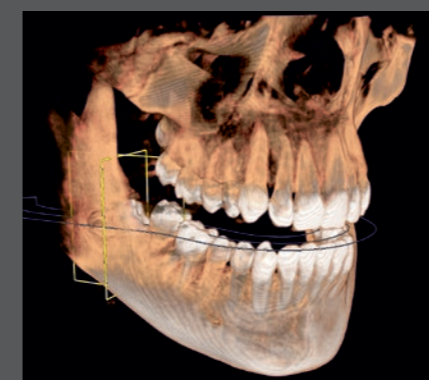

Variety of volumes

Whether for sleep apnea or extracting molars, the ORTHOPHOS SL 3D has a number of volumes for a broad spectrum of applications.



Sharp Layer Technology

Thanks to the SL technology, you not only get high-resolution panoramic images in the sharp layer, but can respond interactively within the image to special cases (lingually/buccally) – without additional imaging.



E[asy] V[olume] I[ndicator] light localizer

In order to make best use of the volume sizes, the EVI light localizer automatically indicates the patient's position in the volume.

SHARPNESS DOWN TO THE SMALLEST DETAIL.

Experience the future of panoramic imaging with the Direct Conversion Sensor (DCS)*. X-rays are converted directly to electrical signals – in contrast to conventional systems there is no signal loss due to light conversion. Your advantage: Incomparable definition.

* Only in the ORTHOPHOS SL.

WITHOUT DCS

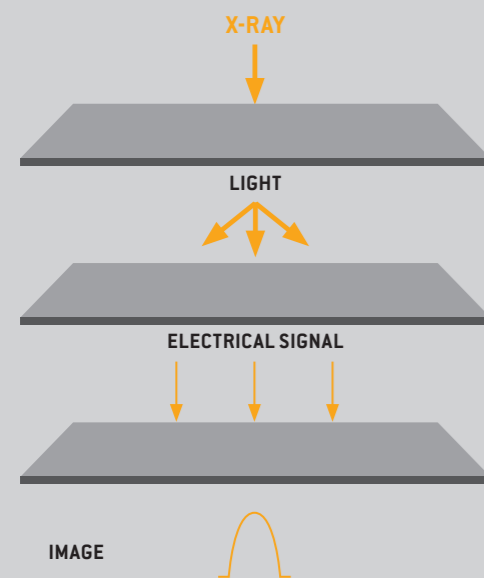

MORE DIRECT WITH DCS

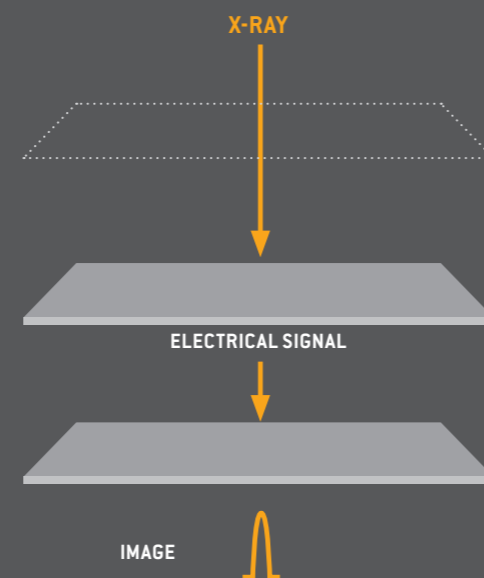

- Unparalleled definition
- Better image quality with the lowest dose

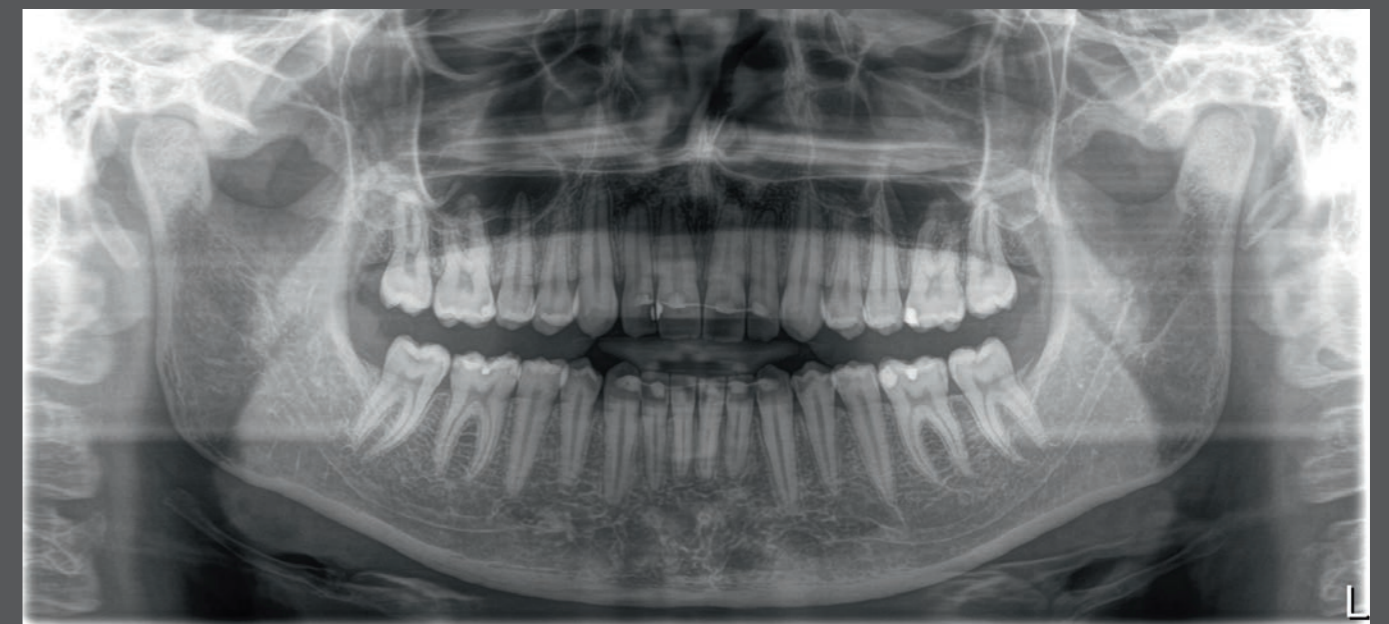

Direct Conversion Sensor (DCS)

Unparalleled image quality with the lowest dose: The Direct Conversion Sensor in ORTHOPHOS SL directly converts X-rays into electrical signals. This leads to less signal loss and an improved yield of image information. The results produce high definition images – at an extremely low dose.

ORTHOPHOS XG 3D

Optimized for daily tasks in the practice: The world's most popular hybrid unit ORTHOPHOS XG 3D combines 2D and 3D X-rays.

With a volume of 8 cm x 8 cm, ORTHOPHOS XG 3D is perfectly adapted to fit the needs of any practice: One scan is sufficient for capturing the entire jaw. MARS (Metal Artifact Reduction Software) reduces artifacts that might occur from metal fillings, and thus prevents incorrect diagnoses. If an even smaller volume is sufficient, choose the reduced volume of 5 cm x 5.5 cm. In difficult cases and for endodontics, the HD mode provides extremely detailed images. In all standard cases, the extensive panoramic and cephalometric programs are guaranteed to deliver the right X-ray image.

OPTIONAL CEPH ARM

The traditional cephalometric function of the ORTHOPHOS XG 3D provides you with lateral and symmetrical p.a. or a.p. images for diagnosis. In cases of displaced teeth, you can also fall back on the benefits of 3D X-ray to determine their exact location.

3D – Now or later



If 3D X-ray does not yet fit into your practice concept today, with ORTHOPHOS XG 3D^{ready} from Sirona you can still switch to the third dimension whenever you want. This unit can be equipped with a 3D module at any time and updated to ORTHOPHOS XG 3D.

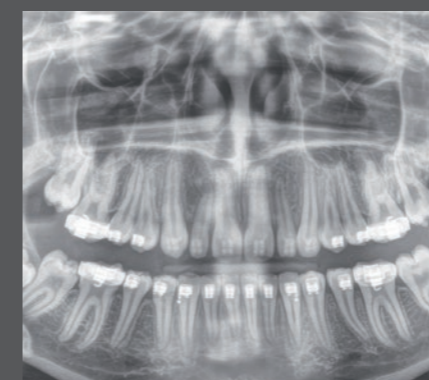

COMPARISON OF STANDARD MODE AND HD MODE



HD image quality with ASTRA
ASTRA provides brilliant, contrast-rich images and thereby creates ideal conditions for a reliable diagnosis.

		
Mode	VOL 1 (8 cm Ø x 8 cm height)	VOL 2 (5 cm Ø x 5.5 cm height)
Standard mode	<ul style="list-style-type: none"> ■ 200 individual images ■ Pulsed radiation ■ Voxel size 160 µm 	<ul style="list-style-type: none"> ■ 200 individual images ■ Pulsed radiation ■ Voxel size 160 µm
HD mode	<ul style="list-style-type: none"> ■ 500 individual images ■ Continuous radiation ■ Voxel size 160 µm 	<ul style="list-style-type: none"> ■ 500 individual images ■ Continuous radiation ■ Voxel size 100 µm

TECHNICAL PROPERTIES.

Overview of performance features	GALILEOS Comfort ^{PLUS}	ORTHOPHOS SL 3D	ORTHOPHOS XG 3D
Imaging volume	15.4 cm spherical imaging volume collimated 15 x 8.5 cm (UJ/LJ)	11 cm Ø x 10 cm height 11 cm Ø x 8 cm height 11 cm Ø x 7.5 cm height 8 cm Ø x 8 cm height 8 cm Ø x 5.5 cm height 5 cm Ø x 5.5 cm height	8 cm Ø x 8 cm height 8 cm Ø x 5.5 cm height 5 cm Ø x 5.5 cm height
3D resolution: Isotropic voxel size	0.25/0.125 mm	0.16 mm; 0.08 mm in HD mode	0.16 mm; 0.1 mm in HD mode
Scan time / exposure time	14 s/2–5 s	2-5 s; 14 s in HD mode	2-5 s; 14 s in HD mode
X-ray generator kV mA	98 3–6	60–90 3–16	60–90 3–16
Minimum space need (depth x width x height)	1,600 x 1,600 x 2,250 mm	1,411 x 1,280 x 2,250 mm	1,411 x 1,280 x 2,250 mm
Door size	For setup at least 66 cm	For setup at least 66 cm	For setup at least 66 cm
Weight	X-ray unit approx. 120 kg	X-ray unit approx. 110 kg	X-ray unit approx. 110 kg
Technical equipment			
Operation	EasyPad	EasyPad	EasyPad
Patient positioning	Standing/seated Chin rest / bite block Forehead support and head fixation	Standing/sitting, chin support/bite block, occlusal bite block with automatic patient positioning, universal bite block with colored stop positions	Standing/sitting, chin support/bite block, occlusal bite block with automatic patient positioning for 2D panoramic images Universal bite block with colored stop positions
Floor stand	<input type="checkbox"/>	<input type="checkbox"/>	<input type="checkbox"/>
Wheelchair appropriate	<input checked="" type="checkbox"/>	<input checked="" type="checkbox"/>	<input checked="" type="checkbox"/>
Remote control	<input type="checkbox"/>	<input type="checkbox"/>	<input type="checkbox"/>
Upgrade options	Facescanner (optional)	Cephalometric X-ray (optional), will soon be available as a pure 2D unit with 3D upgrade option	Cephalometric X-ray (optional), also available as a pure 2D unit with 3D upgrade option

■ Available. □ Optional.

GALILEOS Comfort^{PLUS}: Space requirement at least 1600 mm x 2250 mm

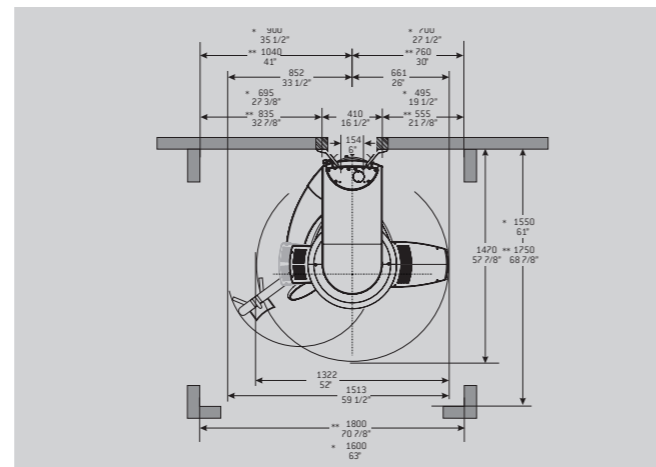
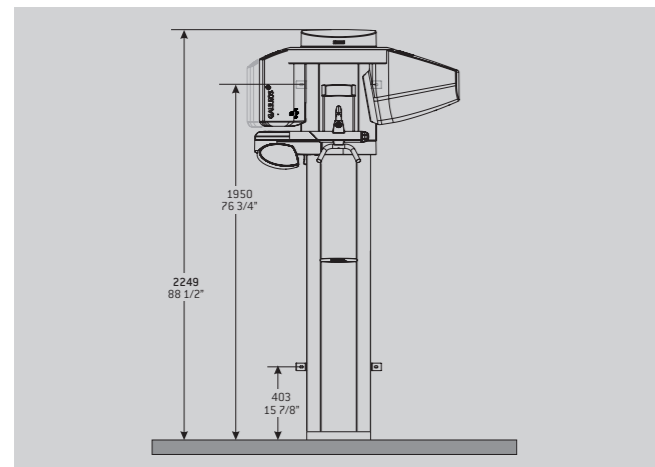

* Minimum space size.
** Recommended space size.

PC REQUIREMENTS FOR SIDEXIS 4*

	Minimum requirements 2D	Minimum requirements 3D
Server PC**		
Operating system	<ul style="list-style-type: none"> Windows 7 Professional Ultimate (64 bit) Windows 8 Pro (64 bit) Windows 8.1 Pro (64 bit) Windows Server 2008 (32 or 64 bit) Windows Server 2008 R2 (64 bit) Windows Server 2012 (64 bit) Windows Server 2012 R2 (64 bit) 	<ul style="list-style-type: none"> Windows Server 2008 (64 bit) Windows Server 2008 R2 (64 bit) Windows Server 2012 (64 bit) Windows Server 2012 R2 (64 bit)
RAM	≥ 4 GB	≥ 8 GB
CPU	≥ 2 GHz DualCore	≥ 2.3 GHz QuadCore processor with 64 bit (x64)
Hard disk***	> 675 GB	> 1 TB
Workstation PC		
Operating system	<ul style="list-style-type: none"> Windows 7 Professional, Ultimate (32 or 64 bit), also under Bootcamp Windows 8 Pro (64 bit) Windows 8.1 Pro (64 bit) 	<ul style="list-style-type: none"> Windows 7 Professional, Ultimate (64 bit), also under Bootcamp Windows 8 Pro (64 bit) Windows 8.1 Pro (64 bit)
RAM	≥ 4 GB	≥ 8 GB
CPU	≥ 2 GHz DualCore	≥ 2.3 GHz QuadCore processor with 64 bit (x64)
Graphics card****	≥ 512 MB	≥ 1 GB
DirectX	DirectX 9.0C	DirectX 10 with WDDM 1.0 or higher driver
Hard disk	≥ 5 GB	≥ 5 GB

* System requirements of the hardware used may vary.
For more information about system requirements: sirona.de/sidexis4-system_requirements
** Installation on a domain controller is not approved.
*** During operation it must be ensured that there is always sufficient hard disk space available.
**** For the interaction with the 3D-rendered volume to be reliable and "smooth", graphics cards with at least the following Passmark GPU benchmark values are recommended:
NVIDIA: Passmark > 1000; ATI: Passmark > 4500

ORTHOPHOS: Space requirements min. 1,280 mm x 1,411 mm

With Ceph arm at least 2,155 mm x 1,411 mm

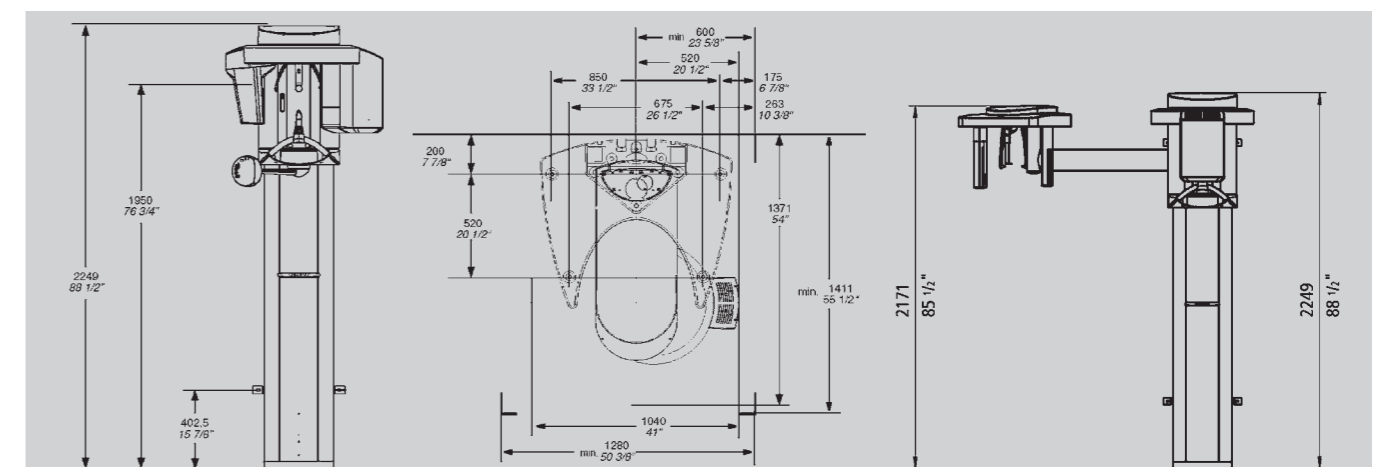

* Minimum space size.
** Recommended space size.

PROGRAMS AT A GLANCE.

This overview shows all 2D programs and the related images of the ORTHOPHOS XG 3D. Differences from the ORTHOPHOS SL 3D are marked accordingly.

Panorama

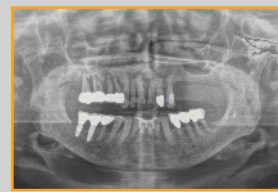

P1 orthoradial radiation

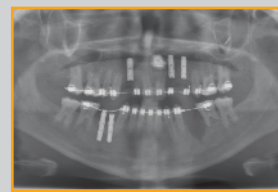

P2 without ascending rami

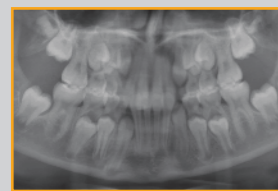

P10 pediatric panorama, beam field reduced in height and length

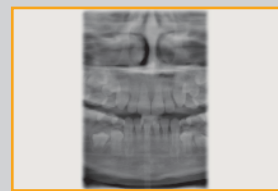

P12 thick slice in anterior tooth region

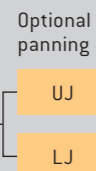
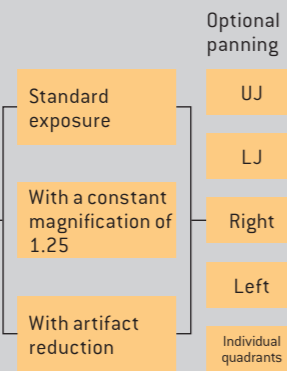

- Quickshot option for all PAN programs
- Automatic adjustment of the rotation curve to the jaw width
- Automatic positioning with occlusal bite block

TMJ

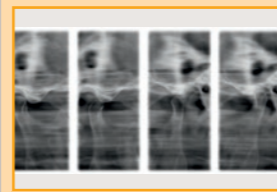

TM1 lateral

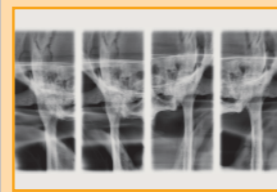

TM2 axial*

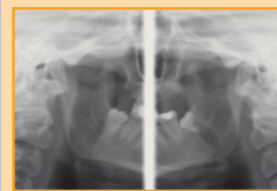

TM3

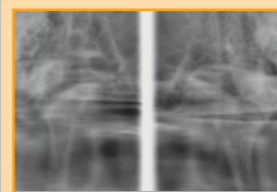

TM4*

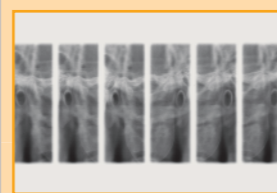

TM5*

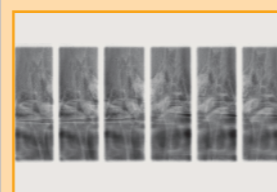

TM6*

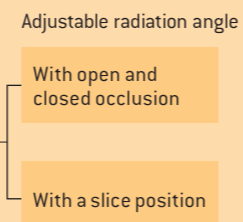

Sinus



S1 jaw cavities

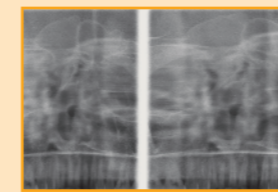

S2 jaw cavities twice*

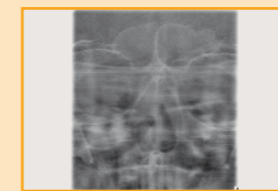

S3 simple jaw cavities linear

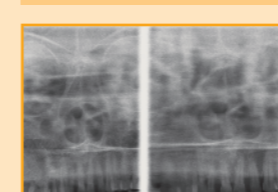

S4 jaw cavities twice linear*

Multislice in posterior tooth region

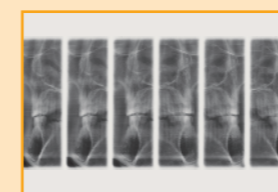

MS1*

Bitewing



BW1

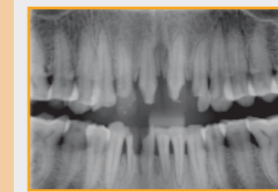

BW2 anterior tooth region

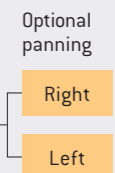

* Image not available with the ORTHOPHOS SL 3D

ALWAYS AT THE FOREFRONT OF INNOVATION!

As global innovation leader for dental equipment, we continuously invest in research and thus in the future of modern dentistry. By networking digital technologies with integrated solutions and optimizing the treatment workflow, we create improved treatment results, more comfort and safety for the patient as well as time and cost savings in everyday work. The combination of constant innovative power and globally growing sales and service structures makes Sirona the global market leader trusted by thousands of practices and labs around the world. **Enjoy every day. With Sirona.**

Subject to technical changes and errors. Order no. A91.100-M47-8872-01-7600. Printed in Germany, Dispo no. 04602, OEM15 WS 0215.V0



CAD/CAM systems

From pioneer to new standard. For 30 years we have been developing digital dentistry and creating new possibilities for the future practice and lab.



Imaging systems

Best image quality with the lowest dose. More than 100 years of developing x-rays for the dental practice make us the number 1 innovation partner.



Treatment centers

The business card of modern practices. We are striving to create the ideal ergonomic and innovative center. Individually tailored to the well-being and demands of the patient and dentist.



Instruments

Advantages that speak for themselves. We make sure that we provide the right balance of proven quality, individual ergonomics and innovative technology for user-friendly work.



Hygiene systems

Competence that gives you safety. When it comes to hygiene in the practice, we do not take any shortcuts.

The Dental Company

sirona.