



Astra Tech Implant System®

Product catalog

OsseoSpeed® TX



Astra Tech Implant System®

CONTENTS

Astra Tech Implant System®	4	Surgical instruments	31
Product overview 3.0	5	Getting started	31
Product overview 3.5/4.0	6	Drills	37
Product overview 4.5/5.0	8	Single Patient drills	37
Surgical components	10	Multiple-use drills	39
Implants	10	Drilling equipment & accessories	41
Cover screws	12	Restorative instruments	43
Healing abutments	12	Getting started	43
Temporary abutments	14	General	44
Cement-retained restorations	15	Repair and retrieval instruments	47
ZirDesign™	16	Compability table	48
TiDesign™	16	Remove/retrieve screw fragments	49
CastDesign™	17	Clean internal threads	50
Impression & laboratory components, implant level	18	Remove UniAbutments/implants	51
Direct Abutment API™	19	Remove/retrieve implants	51
Screw-retained restorations	21	General instruments	52
UniAbutment	22	Removal/retrieval instruments	52
Angled abutments	23	Torque guide	53
Impression & laboratory components, abutment level	24	Material matrix	54
Attachment-retained restorations	26	The numbers within brackets (X) refer to material matrix at page 54.	
Locator™ abutments	27	Explanation of the symbols on labels and instructions for use	55
Ball Abutment	28	Index	56
		Terms of exchange and return	63

* Some products in this catalog are marked "EV".
These particular products are compatible with OsseoSpeed TX.

All products are subject to change without notice. All products may not be regulatory cleared/released/licensed in all markets. Please contact your local Dentsply Sirona representative for current product assortment and availability.

To improve readability for our customers, Dentsply Sirona does not use * or ™ in body copy.
However, Dentsply Sirona does not waive any right to the trademark and nothing herein shall be interpreted to the contrary.

All trademarks and company names are the property of their respective owners.

Product illustrations are not to scale.

Easy to choose and easy to use

The Astra Tech Implant System is simple and reliable: a minimum of components with maximum flexibility. You can use it for all indications and all positions in the mouth. It is ideal for both one-stage and two-stage surgery and it is also suitable for immediate and early loading. The restorative options cover cement-, screw- and attachment-retained solutions.

Easy implant installation—simply pick up and install

The color coded Implant Driver makes implant installation quick, easy and efficient.

Minimum of components with maximum flexibility—one connection, three sizes

To minimize the number of components for simplified treatment planning and inventory management, the Conical Seal Design implant-abutment connection comes in three sizes - x-small, small and large that are color coded for easy identification.



Implant level impression—color coded components

Yellow, aqua and lilac. It has never been easier to select the right implant pick-ups, transfers, guide pins, and replicas. With the color coding system, each component is marked with the same color as the chosen implant connection.



Single Patient Drills

Optimal sharpness, easy handling and no cleaning or sterilization. The benefits of Single Patient Drills are available for all drilling protocols.



Product overview 3.0

Yellow



Indexed abutments and components.

Non-indexed abutments and components (NI).

Implants

OsseoSpeed® TX 3.0 S



11 mm 24982
13 mm 24983
15 mm 24984

Cover screws

3.0



0 mm 24198

Healing abutments

3.0



Ø 4.0 2 mm 24777
Ø 4.0 4 mm 24778
Ø 4.0 6 mm 25017

Cement-retained

Temporary abutments

Temporary Abutment 3.0



Ø 3.4 1 mm 25018

Abutments

TiDesign™ 3.0



Ø 4.0 1 mm 24788
Ø 4.0 2 mm 24789
Ø 4.0 15° 2.4 mm 24790

Atlantis® abutment



Patient-specific abutment
www.atlantisabutment.com

Implant impressions

Implant Pick-up 3.0



Short 24950
Long 24949

Implant Transfer 3.0



Long 24958

Guide pins

Implant Guide Pin 3.0



Short 24970
Long 24976

Replicas

Implant Replica 3.0



24977

Lab abutment screws

Lab Abutment Screw Design 3.0



24802



Product overview 3.5/4.0

Aqua

SMALL

Indexed abutments and components.

SMALL

Non-indexed abutments and components (NI).

Implants

OsseoSpeed® TX 3.5 S



- 8 mm 24930
- 9 mm 24931
- 11 mm 24932
- 13 mm 24933
- 15 mm 24934
- 17 mm 24935

OsseoSpeed® TX 4.0 S



- 6 mm 24939
- 8 mm 24940
- 9 mm 24941
- 11 mm 24942
- 13 mm 24943
- 15 mm 24944
- 17 mm 24945

Cover screws

3.5/4.0



- 0 mm 24328
- 1 mm 24329

Healing abutments

3.5/4.0



- Ø 4.0 2 mm 24574
- Ø 4.5 4 mm 24575
- Ø 4.5 6 mm 24576
- Ø 5.5 2 mm 24577
- Ø 5.5 4 mm 24578
- Ø 5.5 6 mm 24579
- Ø 6.5 4 mm 24580
- Ø 6.5 6 mm 24581

Uni 3.5/4.0



- 2 mm 24374
- 4 mm 24375
- 6 mm 24376
- 8 mm 24377
- 10 mm 24378

Cement-retained

Temporary abutments

TempDesign™ 3.5/4.0



- Ø 4.1 1 mm 22851
- NI Ø 4.1 1 mm 22853

Temporary Abutment 3.5/4.0



- Ø 4.1 1 mm 24281
- NI Ø 4.1 1 mm 24280

Abutments

ZirDesign™ 3.5/4.0



- Ø 4.5 1.5 mm 24702
- Ø 4.5 3 mm 24703
- Ø 5.5 1.5 mm 24704
- Ø 5.5 3 mm 24705
- Ø 5.5 20° 3.5 mm 24706

TiDesign™ 3.5/4.0



- Ø 4.5 1.5 mm 24285
- Ø 4.5 3 mm 24286
- Ø 5.5 1.5 mm 24287
- Ø 5.5 3 mm 24288
- Ø 6.5 1.5 mm 24289
- Ø 6.5 3 mm 24290
- Ø 4.5 20° 3.5 mm 24291
- Ø 5.5 20° 3.5 mm 24292

CastDesign™ 3.5/4.0



- Ø 4 1 mm 22843

Atlantis® abutments



Patient-specific abutments

Screw-retained

Abutments

20° UniAbutment 3.5/4.0



- 0.5 mm 24893
- 1 mm 24894
- 2 mm 24895
- 4 mm 24896
- 6 mm 24897
- 8 mm 24898

45° UniAbutment 3.5/4.0



- 0.5 mm 24899
- 1 mm 24900
- 2 mm 24901
- 4 mm 24902
- 6 mm 24903
- 8 mm 24904

Angled Abutment 3.5/4.0



- Ø 4 0.8 mm 24245
- Ø 4 2 mm 24246
- NI Ø 4 0.8 mm 24347
- NI Ø 4 2 mm 24348

Atlantis® suprastructures



Healing caps



20° ProHeal Cap

- Ø 4.3 24162
- Ø 5.5 Short 24158
- Ø 5.5 Long 24159

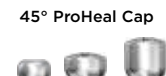

45° ProHeal Cap

- Ø 4.3 24163
- Ø 5.5 Short 24160
- Ø 5.5 Long 24161

Healing Cap, Angled



24092

Attachment-retained

Abutments

Ball Abutment 3.5/4.0



- 1 mm 24905
- 2 mm 24906
- 4 mm 24907
- 6 mm 24908
- 8 mm 24909

Locator™ Abutment 3.5/4.0



- 1 mm 24268
- 2 mm 24269
- 3 mm 24270
- 4 mm 24271
- 5 mm 24272

Abutment impressions

Ball Abutment Pick-up































22439





Locator™ Abutment Pick-up



24484

<p>Direct Abutment API™ 3.5/4.0</p>  <p> Ø 4 0.5 mm 24917 Ø 4 1 mm 24918 Ø 4 2.5 mm 24919 Ø 4 4 mm 24920 Ø 5 1 mm 24921 Ø 5 2.5 mm 24922 Ø 5 4 mm 24923 </p>	<p>Implant impressions</p> <p>Implant Pick-up 3.5/4.0</p>  <p> Short 24947 Long 24948 NI Short 24936 NI Long 24937 </p> <p>Implant Transfer 3.5/4.0</p>  <p> Short 24959 Long 24960 </p>	<p>Lab abutment screws</p> <p>Lab Abutment Screw Design 3.5/4.0</p>  <p>24857</p> <p>Replicas</p> <p>Implant Replica 3.5/4.0</p>  <p>24978</p>	<p>Guide pins</p> <p>Implant Guide Pin 3.5/4.0</p>  <p> Short 24968 Long 24969 </p>
---	---	--	---

<p>Abutment impressions</p> <p>20° UniAbutment Pick-up</p>  <p> Ø 4.3 22882 Ø 5.5 22876 </p> <p>20°/45° UniAbutment Transfer</p>  <p>22068</p> <p>45° UniAbutment Pick-up</p>  <p> Ø 4.3 22883 Ø 5.5 22878 </p> <p>Angled Abutment Pick-up</p>  <p>24254</p>	<p>Replicas</p> <p>20° UniAbutment Replica</p>  <p>22069</p> <p>45° UniAbutment Replica</p>  <p>22070</p> <p>Angled Abutment Replica</p>  <p>24227</p> <p>Lab abutment screws angled</p> <p>Lab Abutment Screw Angled M1.6</p>  <p>24860</p>	<p>Guide pins</p> <p>Abutment Guide Pin</p>  <p> 13 mm 22190 16 mm 22197 19 mm 22198 22 mm 22199 </p> <p>Bridge screws</p> <p>Bridge Screw</p>  <p> Hex 22435 Slot 22167 </p> <p>Lab bridge screws</p> <p>Hex and Slot</p>  <p>24859</p>	<p>Temporary cylinders</p> <p>Temporary Cylinder Uni 20°</p>  <p>22060</p> <p>Temporary Cylinder Uni 45°</p>  <p>22061</p> <p>Temporary Cylinder Uni Angled</p>  <p>22447</p>	<p>Cylinders</p> <p>Semi-Burnout Cylinder Uni 20°</p>  <p>22184</p> <p>Burnout Cylinder Uni 20°</p>  <p>22186</p> <p>Titanium Cylinder Uni 20°</p>  <p>22798</p> <p>Semi-Burnout Cylinder Uni 45°</p>  <p>22185</p> <p>Burnout Cylinder Uni 45°</p>  <p>22187</p> <p>Titanium Cylinder Uni 45°</p>  <p>22799</p> <p>Semi-Burnout Cylinder Uni Angled</p>  <p>24243</p> <p>Burnout Cylinder Uni Angled</p>  <p>22448</p> <p>Titanium Cylinder Uni Angled</p>  <p>24244</p>
---	--	--	--	--

<p>Replicas</p> <p>Ball Abutment Replica</p>  <p>22505</p> <p>Locator™ Abutment Replica</p>  <p>24485</p>	<p>Attachment components</p> <p>Dalbo Plus Female Part TE Basic, complete</p>  <p>25834</p> <p>Locator™ Process Kit</p>  <p>24483</p> <p>Locator™ Insert</p> <p> Blue 24488 Pink 24487 Clear 24486 Grey 25679 Red 24492 Orange 25843 Green 24489 </p>
--	---

Product overview 4.5/5.0

Lilac



LARGE

Indexed abutments and components.



LARGE

Non-indexed abutments and components (NI).

Implants

OsseoSpeed® TX 4.5



- 9 mm 24951
- 11 mm 24952
- 13 mm 24953
- 15 mm 24954
- 17 mm 24955

OsseoSpeed® TX 5.0



- 9 mm 24961
- 11 mm 24962
- 13 mm 24963
- 15 mm 24964
- 17 mm 24965

OsseoSpeed® TX 5.0 S



- 9 mm 24971
- 11 mm 24972
- 13 mm 24973
- 15 mm 24974
- 17 mm 24975

Cover screws

4.5/5.0



- 0 mm 24447
- 1 mm 24448

Healing abutments

4.5/5.0



- Ø 5.5 2 mm 24582
- Ø 5.5 4 mm 24583
- Ø 5.5 6 mm 24584
- Ø 6.5 2 mm 24585
- Ø 6.5 4 mm 24586
- Ø 6.5 6 mm 24587

Uni 4.5/5.0



- 2 mm 24379
- 4 mm 24380
- 6 mm 24381
- 8 mm 24382
- 10 mm 24383

Cement-retained

Temporary abutments

TempDesign™ 4.5/5.0



- Ø 4.5 1 mm 22852
- NI Ø 4.5 1 mm 22854

Temporary Abutment 4.5/5.0



- Ø 4.5 1 mm 25015
- NI Ø 4.5 1 mm 25016

Abutments

ZirDesign™ 4.5/5.0



- Ø 5.5 1.5 mm 24707
- Ø 5.5 3 mm 24708
- Ø 6.5 1.5 mm 24709
- Ø 6.5 3 mm 24710
- Ø 5.5 20° 3.5 mm 24711

TiDesign™ 4.5/5.0



- Ø 5.5 1.5 mm 24235
- Ø 5.5 3 mm 24236
- Ø 6.5 1.5 mm 24237
- Ø 6.5 3 mm 24238
- Ø 5.5 20° 3.5 mm 24239

CastDesign™ 4.5/5.0



- Ø 4.5 1 mm 22844

Atlantis® abutments



Patient-specific abutments

Screw-retained

Abutments

20° UniAbutment 4.5/5.0



- 0.5 mm 24398
- 1 mm 24399
- 2 mm 24400
- 4 mm 24401
- 6 mm 24402
- 8 mm 24403

45° UniAbutment 4.5/5.0



- 0.5 mm 24406
- 1 mm 24407
- 2 mm 24408
- 4 mm 24409
- 6 mm 24410
- 8 mm 24411

Angled Abutment 4.5/5.0



- Ø 4 0.5 mm 24247
- Ø 4 2 mm 24248
- NI Ø 4 0.5 mm 24606
- NI Ø 4 2 mm 24607

Atlantis® suprastructures



Healing caps

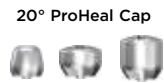

- Ø 4.3 24162
- Ø 5.5 Short 24158
- Ø 5.5 Long 24159

45° ProHeal Cap



- Ø 4.3 24163
- Ø 5.5 Short 24160
- Ø 5.5 Long 24161

Healing Cap, Angled



24092

Attachment-retained

Abutments

Ball Abutment 4.5/5.0



- 0.5 mm 24418
- 1 mm 24419
- 2 mm 24420
- 4 mm 24421
- 6 mm 24422
- 8 mm 24423

Locator™ Abutment 4.5/5.0



- 0.5 mm 24477
- 2 mm 24478
- 3 mm 24479
- 4 mm 24480
- 5 mm 24481

Abutment impressions

Ball Abutment Pick-up































22439





Locator™ Abutment Pick-up



24484

<p>Direct Abutment API™ 4.5/5.0</p>  <p> Ø 5 0.5 mm 24558 Ø 5 1 mm 24559 Ø 5 2.5 mm 24560 Ø 5 4 mm 24561 Ø 6 1 mm 24562 Ø 6 2.5 mm 24563 Ø 6 4 mm 24564 </p>	<p>Implant impressions</p> <p>Implant Pick-up 4.5/5.0</p>  <p> Short 24938 Long 24946 NI Short 24928 NI Long 24929 </p> <p>Implant Transfer 4.5/5.0</p>  <p> Short 24956 Long 24957 </p>	<p>Lab abutment screws</p> <p>Lab Abutment Screw Design 4.5/5.0</p>  <p>24858</p> <p>Replicas</p> <p>Implant Replica 4.5/5.0</p>  <p>24979</p>	<p>Guide pins</p> <p>Implant Guide Pin 4.5/5.0</p>  <p> Short 24966 Long 24967 </p>
--	---	--	---

<p>Abutment impressions</p> <p>20° UniAbutment Pick-up</p>  <p> Ø 4.3 22882 Ø 5.5 22876 </p> <p>20°/45° UniAbutment Transfer</p>  <p>22068</p> <p>45° UniAbutment Pick-up</p>  <p> Ø 4.3 22883 Ø 5.5 22878 </p> <p>Angled Abutment Pick-up</p>  <p>24254</p>	<p>Replicas</p> <p>20° UniAbutment Replica</p>  <p>22069</p> <p>45° UniAbutment Replica</p>  <p>22070</p> <p>Angled Abutment Replica</p>  <p>24227</p> <p>Lab abutment screws angled</p> <p>Lab Abutment Screw Angled M2</p>  <p>24860</p>	<p>Guide pins</p> <p>Abutment Guide Pin</p>  <p> 13 mm 22190 16 mm 22197 19 mm 22198 22 mm 22199 </p> <p>Bridge screws</p> <p>Bridge Screw</p>  <p> Hex 22435 Slot 22167 </p> <p>Lab bridge screws</p> <p>Hex and Slot</p>  <p>24859</p>	<p>Temporary cylinders</p> <p>Temporary Cylinder Uni 20°</p>  <p>22060</p> <p>Temporary Cylinder Uni 45°</p>  <p>22061</p> <p>Temporary Cylinder Uni Angled</p>  <p>22447</p>	<p>Cylinders</p> <p>Semi-Burnout Cylinder Uni 20°</p>  <p>22184</p> <p>Burnout Cylinder Uni 20°</p>  <p>22186</p> <p>Titanium Cylinder Uni 20°</p>  <p>22798</p> <p>Semi-Burnout Cylinder Uni 45°</p>  <p>22185</p> <p>Burnout Cylinder Uni 45°</p>  <p>22187</p> <p>Titanium Cylinder Uni 45°</p>  <p>22799</p> <p>Semi-Burnout Cylinder Uni Angled</p>  <p>24243</p> <p>Burnout Cylinder Uni Angled</p>  <p>22448</p> <p>Titanium Cylinder Uni Angled</p>  <p>24244</p>
---	--	--	--	--

<p>Replicas</p> <p>Ball Abutment Replica</p>  <p>22505</p> <p>Locator™ Abutment Replica</p>  <p>24485</p>	<p>Attachment components</p> <p>Dalbo Plus Female Part TE Basic, complete</p>  <p>25834</p> <p>Locator™ Process Kit</p>  <p>24483</p> <p>Locator™ Insert</p> <p> Blue 24488 Pink 24487 Clear 24486 Grey 25679 Red 24492 Orange 25843 Green 24489 </p>
--	---

MEASUREMENTS

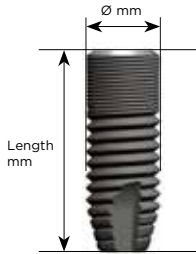

SHORT FACTS

- X-Small connection – Yellow: Implant diameter 3.0
- Small connection – Aqua: Implant diameters 3.5 and 4.0.
- Large connection – Lilac: Implant diameters 4.5 and 5.0.

Implants for all indications in both the anterior and posterior region.
 For indication details – see Instructions for use or Surgical procedures manual.
 All our implants are made of commercially pure titanium, grade 4.
 OsseoSpeed surface treatment over the entire implant to the top of the first MicroThread.
 S = Straight implant design



OsseoSpeed® TX 3.0 S

Titanium (1), sterile
 OsseoSpeed, with a TiO₂-blasted fluoride-modified surface.
 MicroThread neck.
 Conical Seal Design connection.
 Internal double hexagon.
 Ø 3.0 mm
 Internal thread M1.4

■ **OsseoSpeed® TX 3.0 S**



Length mm				11	13	15	
Order No.				24982	24983	24984	

OsseoSpeed® TX 3.5 S

Titanium (1), sterile
 OsseoSpeed, with a TiO₂-blasted fluoride-modified surface.
 MicroThread neck.
 Conical Seal Design connection.
 Internal double hexagon.
 Ø 3.5 mm
 Internal thread M1.6

■ **OsseoSpeed® TX 3.5 S**



Length mm		8	9	11	13	15	17
Order No.		24930	24931	24932	24933	24934	24935

OsseoSpeed® TX 4.0 S

Titanium (1), sterile
 OsseoSpeed, with a TiO₂-blasted fluoride-modified surface.
 MicroThread neck.
 Conical Seal Design connection.
 Internal double hexagon.
 Ø 4.0 mm
 Internal thread M1.6

■ **OsseoSpeed® TX 4.0 S**



Length mm	6	8	9	11	13	15	17
Order No.	24939	24940	24941	24942	24943	24944	24945

OsseoSpeed® TX 4.5



Length mm	9	11	13	15	17
Order No.	24951	24952	24953	24954	24955

OsseoSpeed® TX 4.5

Titanium (1), sterile
OsseoSpeed, with a TiO₂-blasted fluoride-modified surface.
MicroThread neck.
Conical Seal Design connection.
Internal double hexagon.
Ø 4.5/3.5 mm
Internal thread M2

OsseoSpeed® TX 5.0



Length mm	9	11	13	15	17
Order No.	24961	24962	24963	24964	24965

OsseoSpeed® TX 5.0

Titanium (1), sterile
OsseoSpeed, with a TiO₂-blasted fluoride-modified surface.
MicroThread neck.
Conical Seal Design connection.
Internal double hexagon.
Ø 5.0/4.0 mm
Internal thread M2

OsseoSpeed® TX 5.0 S



Length mm	9	11	13	15	17
Order No.	24971	24972	24973	24974	24975

OsseoSpeed® TX 5.0 S

Titanium (1), sterile
OsseoSpeed, with a TiO₂-blasted fluoride-modified surface.
MicroThread neck.
Conical Seal Design connection.
Internal double hexagon.
Ø 5.0 mm
Internal thread M2

Radiographic Implant Guides



Order No.	24892
-----------	-------

Radiographic Implant Guides

Plastic (12), non-sterile

- Planning tools used prior to implant surgery
- Used together with x-ray of the patients' jaw
- Magnification range is from 1.0 to 1.8 presented in 9 separate sheets

Cover Screw 3.0

Titanium (1), sterile
Used to cover the implant connection during healing.

Cover Screw 3.0



Ø mm	2.3
Height mm	0
Order No.	24198

MEASUREMENTS

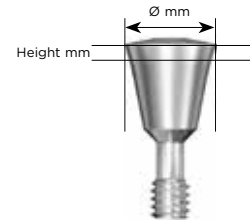

Cover Screw 3.5/4.0

Titanium (1), sterile
Used to cover the implant connection during healing.

Cover Screw 3.5/4.0



Ø mm	2.9	3.1
Height mm	0	1
Order No.	24328	24329

SHORT FACTS

Recommended torque - Manual.
Only light fingerforce (5-10 Ncm) using a manual hex screwdriver.
Do not use a Ratchet or Torque Wrench.

Cover Screw 4.5/5.0

Titanium (1), sterile
Used to cover the implant connection during healing.

Cover Screw 4.5/5.0



Ø mm	3.9	4.6
Height mm	0	1
Order No.	24447	24448

MEASUREMENTS

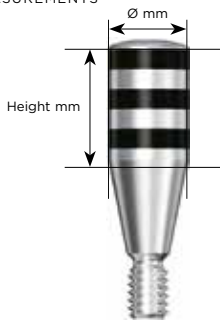

SHORT FACTS

Recommended torque - Manual.
Only light fingerforce (5-10 Ncm) using a manual hex screwdriver.
Do not use a Ratchet or Torque Wrench.



Marked with lines to identify connection size.
3.5/4.0 - marked with 2 lines.
4.5/5.0 - marked with 3 lines.
Marked with digit to identify height.

Healing Abutment Uni 3.5/4.0

Titanium (1), sterile
Laser etched bands for measuring mucosal height over the implant.

Healing Abutment Uni 3.5/4.0



Ø mm	4	4	4	4	4
Height mm	2	4	6	8	10
Order No.	24374	24375	24376	24377	24378

Healing Abutment Uni 4.5/5.0

Titanium (1), sterile
Laser etched bands for measuring mucosal height over the implant.

Healing Abutment Uni 4.5/5.0



Ø mm	4	4	4	4	4
Height mm	2	4	6	8	10
Order No.	24379	24380	24381	24382	24383

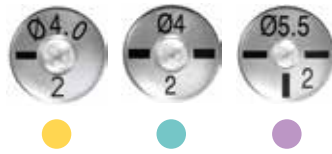
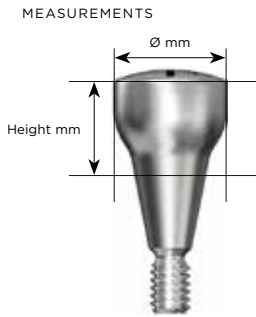

SHORT FACTS
Recommended torque - Manual.
Only light fingerforce (5-10 Ncm)
using a manual hex screwdriver.
Do not use a Ratchet or
Torque Wrench.

Marked with lines to identify connection size.
3.0 - marked with 1 line.
3.5/4.0 - marked with 2 lines.
4.5/5.0 - marked with 3 lines.
Marked with digits to identify diameter (Ø)
and height.

Healing Abutment 3.0



Ø mm	4	4	4
Height mm	2	4	6
Order No.	24777	24778	25017

Healing Abutment 3.0
Titanium (I), sterile

Healing Abutment 3.5/4.0



Ø mm	4	4.5	4.5	5.5	5.5	5.5	6.5	6.5
Height mm	2	4	6	2	4	6	4	6
Order No.	24574	24575	24576	24577	24578	24579	24580	24581

Healing Abutment 3.5/4.0
Titanium (I), sterile

Healing Abutment 4.5/5.0



Ø mm	5.5	5.5	5.5	6.5	6.5	6.5
Height mm	2	4	6	2	4	6
Order No.	24582	24583	24584	24585	24586	24587

Healing Abutment 4.5/5.0
Titanium (I), sterile

TempDesign™ 3.5/4.0

Base: Titanium (2)
 Cylinder: Plastic (12)
 Non-sterile
 Includes Abutment Screw Design
 3.5/4.0 - M1.6, Order No. 24449
 (Titanium)
 NI = Non Indexed



TempDesign™ 3.5/4.0

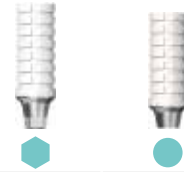

Ø mm	4.1	NI
Height (Margin) mm	1	1
Vert. height mm	10	10
Order No.	22851	22853

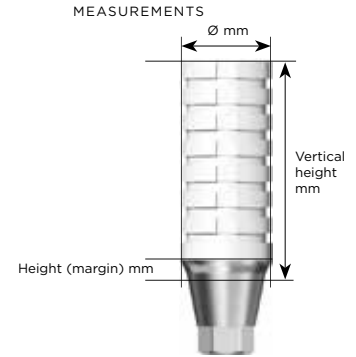

SHORT FACTS
 Recommended torque for
 temporization - 15 Ncm.

TempDesign™ 4.5/5.0

Base: Titanium (1)
 Cylinder: Plastic (12)
 Non-sterile
 Includes Abutment Screw Design
 4.5/5.0 - M2, Order No. 24209
 (Titanium)



TempDesign™ 4.5/5.0

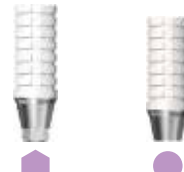

Ø mm	4.5	NI
Height (Margin) mm	1	1
Vert. height mm	10	10
Order No.	22852	22854

Temporary Abutment 3.0

Titanium (2), non-sterile
 Includes Abutment Screw 3.0
 - M1.4, Order No. 24189
 (Titanium)



**Temporary
 Abutment 3.0**



Ø mm	3.4
Height (Margin) mm	1
Vert. height mm	9
Order No.	25018

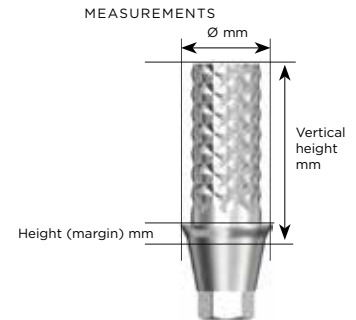

SHORT FACTS
 Recommended torque for
 temporization - 15 Ncm.

Temporary Abutment 3.5/4.0

Titanium (2), non-sterile
 Includes Abutment Screw Design
 3.5/4.0 - M1.6, Order No. 24449
 (Titanium)
 NI = Non Indexed



**Temporary
 Abutment 3.5/4.0**

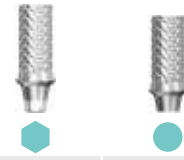

Ø mm	4.1	NI
Height (Margin) mm	1	1
Vert. height mm	9	9
Order No.	24281	24280

Temporary Abutment 4.5/5.0

Titanium (1), non-sterile
 Includes Abutment Screw Design
 4.5/5.0 - M2, Order No. 24209
 (Titanium)



**Temporary
 Abutment 4.5/5.0**



Ø mm	4.5	NI
Height (Margin) mm	1	1
Vert. height mm	9	9
Order No.	25015	25016

Components for cement-retained restorations



Optimal function and long-lasting esthetics

The restorative assortment for cement-retained solutions covers everything you need in order to create optimal function and natural long-lasting esthetics. The assortment includes a wide range of abutments in order to successfully meet every clinical indication. The components are designed to give optimal treatment results for single, partial and full jaw bridge restorations.

The absolute top-of-the-line when it comes to cement-retained restorations is Atlantis patient-specific abutments for all major implant systems. The Atlantis abutment is available in different materials, such as titanium, gold-shaded titanium, white and shaded zirconia.

For more information about Atlantis abutment, please contact your local sales representative or visit www.dentsplyimplants.com.

Cement-retained restorations
Cement-retained abutments

MEASUREMENTS

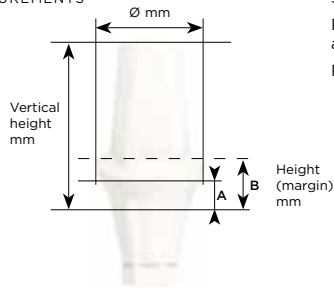

SHORT FACTS

Pre-designed for quick and easy adjustment.
Recommended torque - ● 20 Ncm
● 25 Ncm

ZirDesign™ 3.5/4.0

Zirconia (18), non-sterile

Includes Abutment Screw Design 3.5/4.0 - M1.6, Order No. 24449 (Titanium)



ZirDesign™ 3.5/4.0



Angulation					20°
Ø mm	4.5	4.5	5.5	5.5	5.5
Height bucc A mm	1.5	3	1.5	3	3.5
Height ling B mm	2.5	4	2.5	4	3.5
Vertical height mm	9	10	9	10	9.5
Order No.	24702	24703	24704	24705	24706

ZirDesign™ 4.5/5.0

Zirconia (18), non-sterile

Includes Abutment Screw Design 4.5/5.0 - M2, Order No. 24209 (Titanium)



ZirDesign™ 4.5/5.0



Angulation					20°
Ø mm	5.5	5.5	6.5	6.5	5.5
Height bucc A mm	1.5	3	1.5	3	3.5
Height ling B mm	2.5	4	2.5	4	3.5
Vertical height mm	9	10	9	10	9.5
Order No.	24707	24708	24709	24710	24711

MEASUREMENTS

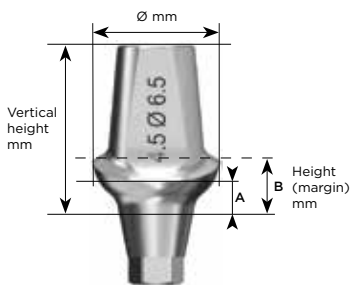

SHORT FACTS

Pre-designed for quick and easy adjustment.
Recommended torque - ● 15 Ncm
● 20 Ncm
● 25 Ncm

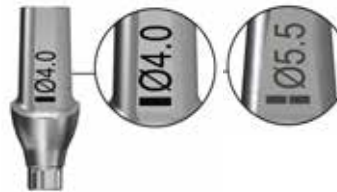

Marked with lines to identify connection size
3.0 - marked with one line.
3.5/4.0 - marked with two lines.
Marked with digits to identify diameter (Ø) and height.

TiDesign™ 3.0



TiDesign™ 3.0

Titanium (2), non-sterile

Includes Abutment Screw 3.0 - M1.4, Order No. 24189 (Titanium)



Angulation			15°
Ø mm	4.0	4.0	4.0
Height bucc A mm	1	2	2.4
Height ling B mm	1.5	2.5	2.4
Vertical height mm	7	8	7
Order No.	24788	24789	24790

TiDesign™ 3.5/4.0



Angulation							20°	20°
Ø mm	4.5	4.5	5.5	5.5	6.5	6.5	4.5	5.5
Height bucc A mm	1.5	3	1.5	3	1.5	3	3.5	3.5
Height ling B mm	2.5	4	2.5	4	2.5	4	3.5	3.5
Vertical height mm	9	10	9	10	9	10	9.5	9.5
Order No.	24285	24286	24287	24288	24289	24290	24291	24292

TiDesign™ 3.5/4.0

Titanium (2), non-sterile

Includes Abutment Screw Design 3.5/4.0 – M1.6, Order No. 24449 (Titanium)



TiDesign™ 4.5/5.0



Angulation					20°
Ø mm	5.5	5.5	6.5	6.5	5.5
Height bucc A mm	1.5	3	1.5	3	3.5
Height ling B mm	2.5	4	2.5	4	3.5
Vertical height mm	9	10	9	10	9.5
Order No.	24235	24236	24237	24238	24239

TiDesign™ 4.5/5.0

Titanium (1), non-sterile

Includes Abutment Screw Design 4.5/5.0 – M2, Order No. 24209 (Titanium)



CastDesign™ 3.5/4.0



Ø mm	4.1
Height (margin) mm	1
Vertical height mm	10
Order No.	22843

CastDesign™ 3.5/4.0

Base: Non-oxidizing gold alloy (3)
Cylinder: Burnout plastic (11)
Non-sterile

Includes Abutment Screw Design 3.5/4.0 – M1.6, Order No. 24449 (Titanium, (2))



MEASUREMENTS

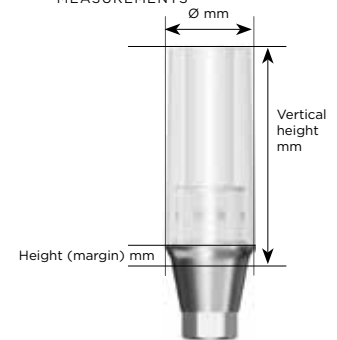

CastDesign™ 4.5/5.0



Ø mm	4.5
Height (margin) mm	1
Vertical height mm	10
Order No.	22844

CastDesign™ 4.5/5.0

Base: Non-oxidizing gold alloy (3)
Cylinder: Burnout plastic (11)
Non-sterile

Includes Abutment Screw Design 4.5/5.0 – M2, Order No. 24209 (Titanium, (2))



SHORT FACTS

Recommended torque - ● 20 Ncm
● 25 Ncm

Implant Pick-up
3.0, 3.5/4.0, 4.5/5.0

Titanium (2)
 NI = Non Indexed
 Two piece component:
 includes pick-up and guide pin.

Implant Pick-up
3.0, 3.5/4.0, 4.5/5.0



	Short	Long	Short	Long	Short	Long	NI-Short	NI-Long	NI-Short	NI-Long
Length mm	21	26	21	26	22	27	21	26	22	27
Order No.	24950	24949	24947	24948	24938	24946	24936	24937	24928	24929

Implant Transfer
3.0, 3.5/4.0, 4.5/5.0

Titanium (2)
 Internal thread.
 Two piece component:
 includes sleeve and pin.

Implant Transfer
3.0, 3.5/4.0, 4.5/5.0



	Long	Short	Long	Short	Long
Length mm	19	16	19	18	21
Order No.	24958	24959	24960	24956	24957

Implant Replica
3.0, 3.5/4.0, 4.5/5.0

Titanium (2)

Implant Replica
3.0, 3.5/4.0, 4.5/5.0



Length mm	15	15	15.5
Order No.	24977	24978	24979

Implant Guide Pin
3.0, 3.5/4.0, 4.5/5.0

Titanium (2)
 Used when working with
 abutments tightened with
 Abutment screw - M1.4 ●
 Abutment screw - M1.6 ●
 Abutment screw - M2 ●

Implant Guide Pin
3.0, 3.5/4.0, 4.5/5.0

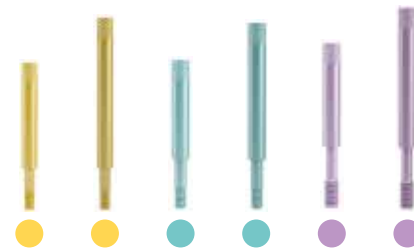

	Short	Long	Short	Long	Short	Long
Length mm	21	26	21	26	22	27
Order No.	24970	24976	24968	24969	24966	24967

MEASUREMENTS

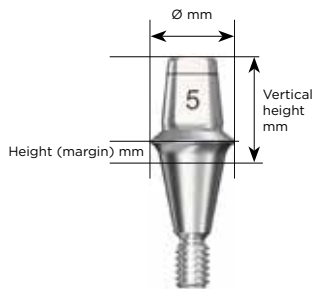

SHORT FACTS

6 degree tapered top cone.
Laser marked line for simplified occlusal reduction at 1 mm line.
Recommended torque - ● 25 Ncm
● 25 Ncm
Marked with digit to identify diameter (Ø).



● Direct Abutment API™ 3.5/4.0



Ø mm	4	4	4	4
Height (margin) mm	0.5	1	2.5	4
Order No.	24917	24918	24919	24920



Ø mm	5	5	5
Height (margin) mm	1	2.5	4
Order No.	24921	24922	24923

Direct Abutment API™ 3.5/4.0

API = All parts included

DA 4 Metal Carrier for seating and retrieval of Direct Abutment Ø 4, see pages 20 and 49.

● Direct Abutment API™ 4.5/5.0



Ø mm	5	5	5	5
Height (margin) mm	0.5	1	2.5	4
Order No.	24558	24559	24560	24561



Ø mm	6	6	6
Height (margin) mm	1	2.5	4
Order No.	24562	24563	24564

Direct Abutment API™ 4.5/5.0

API = All parts included

Direct Abutment™ 3.5/4.0
 Titanium (2), non-sterile

Direct Abutment™ 3.5/4.0



Ø mm	4	4	4	4	5	5	5
Height (margin) mm	0.5	1	2.5	4	1	2.5	4
Vertical height mm	6	6	8	9	6	8	9
Order No.	24910	24911	24912	24913	24914	24915	24916

Direct Abutment™ 4.5/5.0
 Titanium (1), non-sterile

Direct Abutment™ 4.5/5.0



Ø mm	5	5	5	5	6	6	6
Height (margin) mm	0.5	1	2.5	4	1	2.5	4
Vertical height mm	6	6	8	9	6	8	9
Order No.	24527	24528	24529	24530	24537	24538	24539

Direct Abutment™ Healing Cap
 PC plastic (12), non-sterile

Direct Abutment™ Healing Cap



Ø mm	4	5	6
Order No.	22720	22721	22722

Direct Abutment™ Impression Pick-up
 PP plastic (13), non-sterile

Direct Abutment™ Impression Pick-up



Ø mm	4	5	6
Order No.	22710	22711	22712

Direct Abutment™ Replica
 Stainless steel (6), non-sterile

Direct Abutment™ Replica



Ø mm	4	5	6
Order No.	22054	22064	22065

Direct Abutment™ Burnout Cylinder
 PMMA Burn-out Plastic (11), non-sterile

Direct Abutment™ Burnout Cylinder



Ø mm	4	5	6
Order No.	22372	22373	22379

Direct Abutment™ Carrier
 Plastic (12)/Stainless steel (6)
 DA 4 Metal Carrier for seating and retrieval of Direct Abutment Ø 4, 17 mm

Direct Abutment™ Carrier



Ø mm	4	5	6	4
Order No.	24137	24138	24139	22850

Components for screw-retained restorations

Well documented solutions for predictable clinical success

For screw-retained restorations, the Astra Tech Implant System provides abutments for all treatment indications. The components are designed for full flexibility and optimal results for partial as well as full jaw restorations. The UniAbutment, with its conical abutment top supporting the restoration, provide mechanical, clinical and biological support. The flexibility for implants placed in non-parallel positions with limited vertical space available, provides freedom and satisfaction for each clinician.

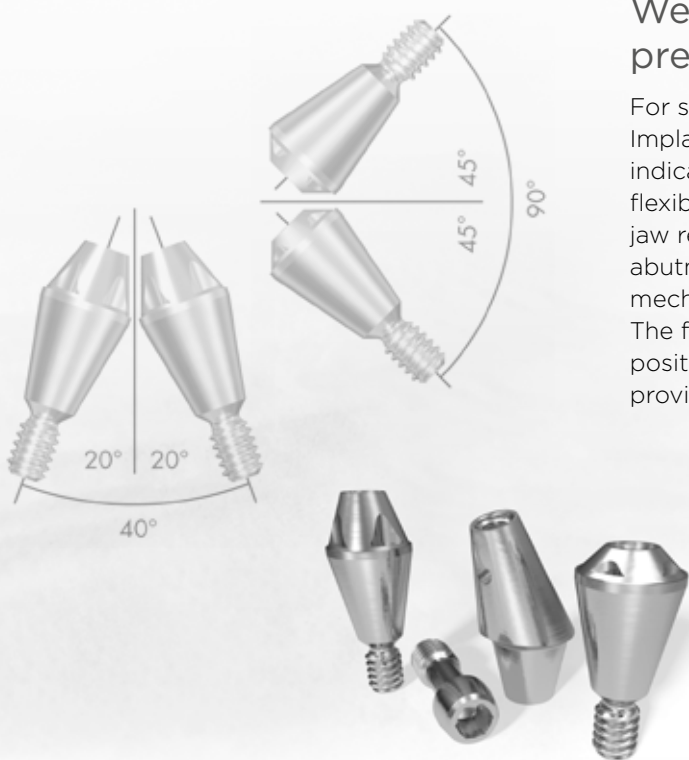

Atlantis patient-specific abutments, crowns, bars & bridges. The digital solutions from Dentsply Sirona Implants support you from the planning to the final restoration and offer the possibilities to work with a complete digital workflow.



For more information, please contact your local sales representative, or visit www.dentsplyimplants.com

Screw-retained restorations
UniAbutment

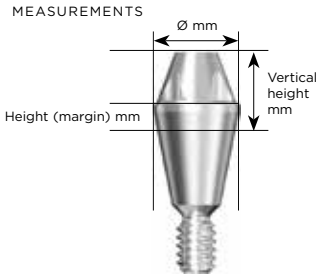

SHORT FACTS

Height of 20° tapered top cone - 2.15 mm.
Height of 45° tapered top cone - 0.8 mm.
Removal grooves.
Pre-mounted with carrier.
Recommended torque - 15 Ncm.



20° UniAbutment 3.5/4.0
Titanium (2), sterile
20° tapered top

● **20° UniAbutment 3.5/4.0**



Ø mm	3.5	3.5	3.5	3.5	3.5	3.5
Height (margin) mm	0.5	1	2	4	6	8
Vertical height mm	2.5	3	4	6	8	10
Order No.	24893	24894	24895	24896	24897	24898

45° UniAbutment 3.5/4.0
Titanium (2), sterile
45° tapered top

● **45° UniAbutment 3.5/4.0**



Ø mm	3.5	3.5	3.5	3.5	3.5	3.5
Height (margin) mm	0.5	1	2	4	6	8
Vertical height mm	1	2	3	5	7	9
Order No.	24899	24900	24901	24902	24903	24904

20° UniAbutment 4.5/5.0
Titanium (1), sterile
20° tapered top

● **20° UniAbutment 4.5/5.0**



Ø mm	3.5	3.5	3.5	3.5	3.5	3.5
Height (margin) mm	0.5	1	2	4	6	8
Vertical height mm	2.5	3	4	6	8	10
Order No.	24398	24399	24400	24401	24402	24403

45° UniAbutment 4.5/5.0
Titanium (1), sterile
45° tapered top

● **45° UniAbutment 4.5/5.0**



Ø mm	3.5	3.5	3.5	3.5	3.5	3.5
Height (margin) mm	0.5	1	2	4	6	8
Vertical height mm	1	2	3	5	7	9
Order No.	24406	24407	24408	24409	24410	24411



Easy to remove the UniAbutment with
Removal Tool M1.4, see page 49.

Angled Abutment 3.5/4.0



Ø mm	4	4	NI	NI
Height (Margin) mm	0.8	2	0.8	2
Vert. height mm	6	7	6	7
Order No.	24245	24246	24347	24348

MEASUREMENTS

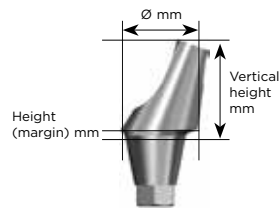

SHORT FACTS

Recommended torque

- 20 Ncm
- 25 Ncm

Angled Abutment 3.5/4.0

Titanium (2), sterile

Angulation 20°

Includes Abutment Screw Angled 3.5/4.0 - M1.6, Order No. 24439 (Titanium)



Angled Abutment 4.5/5.0

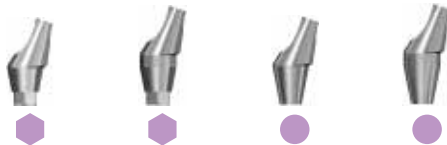

Ø mm	4	4	NI	NI
Height (Margin) mm	0.5	2	0.5	2
Vert. height mm	6	7	6	7
Order No.	24247	24248	24606	24607

Angled Abutment 4.5/5.0

Titanium (1), sterile

Angulation 20°

Includes Abutment Screw Angled 4.5/5.0 - M2, Order No. 22487 (Titanium)



20° ProHeal Cap



	Short	Short	Long
Ø mm	4.3	5.5	5.5
Height mm	4	3.8	5.8
Order No.	24162	24158	24159

MEASUREMENTS

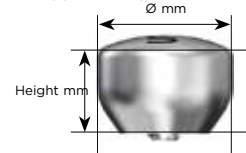

SHORT FACTS

Recommended torque - Manual.

Only light fingerforce (5-10 Ncm) using a manual hex screwdriver. Do not use a Ratchet or Torque Wrench.

20° ProHeal Cap

Titanium (1), sterile

Healing cap for 20° UniAbutments.

45° ProHeal Cap



	Short	Short	Long
Ø mm	4.3	5.5	5.5
Height mm	2.7	3.8	5.8
Order No.	24163	24160	24161

45° ProHeal Cap

Titanium (1), sterile

Healing cap for 45° UniAbutments.

Healing Cap Angled



Ø mm	5
Height mm	7.5
Order No.	24092

Healing Cap Angled

Titanium (1), sterile

Includes Bridge Screw, Slot, Order No. 22167



MEASUREMENTS

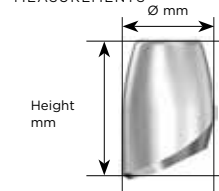

SHORT FACTS

Recommended torque - Manual.

20° UniAbutment Pick-up

Stainless steel (6)

Two piece component: pick-up and guide pin.

20° UniAbutment Pick-up



Ø mm	4.3	5.5
Order No.	22882	22876

45° UniAbutment Pick-up

Stainless steel (6)

Two piece component: pick-up and guide pin.

45° UniAbutment Pick-up



Ø mm	4.3	5.5
Order No.	22883	22878

20°/45° UniAbutment Transfer

Stainless steel (6)

Used for 20° and 45° UniAbutment. When using transfer, information on which abutment used must be communicated to the lab.

20°/45° UniAbutment Transfer



Order No.	22068
-----------	-------

Angled Abutment Pick-up

Stainless steel (6)

Two piece component: pick-up and guide pin.

Angled Abutment Pick-up



Order No.	24254
-----------	-------

Abutment Replica

Stainless steel (6)

Abutment Replica



	Uni 20°	Uni 45°	Angled
Order No.	22069	22070	24227

Abutment Guide Pin, M1.4

Stainless steel (6)

Abutment Guide Pin, M1.4



Length mm	13	16	19	22
Order No.	22190	22197	22198	22199

Bridge Screw, M1.4

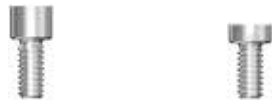

	Hex	Slot
Screw head Ø mm	2.3	2.3
Head depth mm	1.8	1
Order No.	22435	22167

Bridge Screw, M1.4

Titanium (2)

Recommended torque is 15 Ncm.

Temporary Cylinder



	Uni 20°	Uni 45°	Angled
Order No.	22060	22061	22447

Temporary Cylinder

Titanium (1)

Semi-Burnout Cylinder



	Uni 20°	Uni 45°	Angled
Order No.	22184	22185	24243

Semi-Burnout Cylinder

Base: Non-oxidizing gold alloy (3)
 Cylinder: Plastic (12)

Burnout Cylinder



	Uni 20°	Uni 45°	Angled
Order No.	22186	22187	22448

Burnout Cylinder

Plastic (12)

Titanium Cylinder



	Uni 20°	Uni 45°	Angled
Order No.	22798	22799	24244

Titanium Cylinder

Base: Titanium (1)
 Cylinder: Plastic (12)

Components for Attachment-retained restorations

Attached to implants

There are several indications for overdenture treatment in connection with implant therapy. Functional, esthetic, phonetic and hygienic requirements in certain clinical situations support the use of the overdenture as a treatment option. The presence of at least one implant in each quadrant of the jaw, combined with a suitable attachment system, makes overdenture treatment a viable alternative when treating totally edentulous jaws.



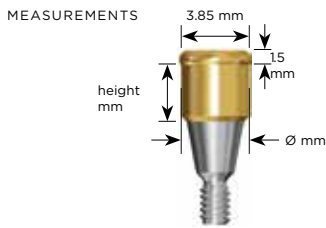

SHORT FACTS
 Diameter of Locator retention top – 3.85 mm.
 1.5 mm of the top should be supragingival to be able to retain the overdenture.
 Recommended torque – ● 25 Ncm
 ● 25 Ncm

Locator™ Abutment 3.5/4.0



Ø mm	3.7	3.7	3.7	3.7	3.7
Height mm	1	2	3	4	5
Order No.	24268	24269	24270	24271	24272

Locator™ Abutment 3.5/4.0

Titanium (2)
TiN-coating (8)

Locator™ Abutment 4.5/5.0



Ø mm	4.0	4.0	4.0	4.0	4.0
Height mm	0.5	2	3	4	5
Order No.	24477	24478	24479	24480	24481

Locator™ Abutment 4.5/5.0

Titanium (2)
TiN-coating (8)

Locator™ Abutment Pick-up Abutment Replica



Order No.	24484	24485
-----------	-------	-------

Locator™ Abutment Pick-up

Locator™ Abutment Replica
Aluminum (7)
QTY 4

Locator™ Process Kit



Order No.	24483
-----------	-------

Locator™ Process Kit

QTY 2 sets

Locator™ Insert – Male



Grams	680	1361	2268
Retention force, kg	0.7	1.4	2.3
Order No.	24488	24487	24486

Locator™ Insert – Male

Nylon (16), non-sterile
 The clear, pink and blue insert retention parts allow for a divergence of up to 10° for a single implant and up to 40° between implants.
 QTY 4

Locator™ Insert – Extended Range Male



Grams	0	226-680	907	1361-1814
Retention force, kg	0	0.5	0.9	1.8
Order No.	25679	24492*	25843	24489*

Locator™ Insert – Extended Range Male

Nylon (16), non-sterile
 The grey, red, orange and green inserts permit a divergence of 10–20° for a single implant and up to 40° between implants. The grey insert is used temporary during long-term treatment for protecting the abutments.
 QTY 4

Attachment-retained restorations
Locator™ and Ball Abutment

Locator™ Core Tool
Stainless steel (6)

Locator™ Core Tool



Order No.	24482
-----------	-------

Locator™ Torque Wrench Bit
Stainless steel (6)

Locator™ Torque Wrench Bit



	15 mm	21 mm
Order No.	24490	24491

Locator™ Driver EV
Stainless steel (6)

Locator™ Driver EV



	23 mm
Order No.	25766

MEASUREMENTS

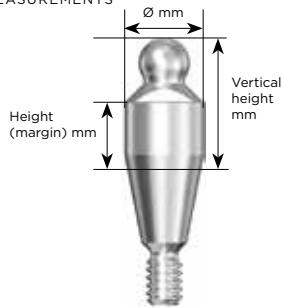

SHORT FACTS

Height of the ball from the margin - 2.85 mm.
Installed using Ball Wrench, Order No. 24367.
Recommended torque - ● 25 Ncm
● 25 Ncm

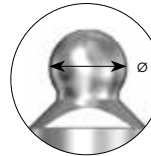

Diameter of the ball - 2.25 mm.

Ball Abutment 3.5/4.0
Titanium (2), sterile
Ball Ø 2.25 mm

● **Ball Abutment 3.5/4.0**



Ø mm		3.5	3.5	3.5	3.5	3.5
Height (margin) mm		1	2	4	6	8
Vert. height mm		4	5	7	9	11
Order No.		24905	24906	24907	24908	24909

Ball Abutment 4.5/5.0
Titanium (1), sterile
Ball Ø 2.25 mm

● **Ball Abutment 4.5/5.0**



Ø mm	3.5	3.5	3.5	3.5	3.5	3.5
Height (margin) mm	0.5	1	2	4	6	8
Vert. height mm	3.5	4	5	7	9	11
Order No.	24418	24419	24420	24421	24422	24423



Restorative abutment options
for overdenture treatment.

Ball Abutment Pick-up



Order No.	22439
-----------	-------

Ball Abutment Replica



Order No.	22505
-----------	-------

Ball Abutment Pick-up

Plastic (12)

Ball Abutment Replica

Stainless steel (6)

Ball Wrench



Order No.	24367
-----------	-------

Ball Driver EV



Order No.	25768
-----------	-------

Ball Wrench

Stainless steel (6)

Wrench for seating and retrieval of Ball Abutment. Used together with Ratchet Wrench, Torque Wrench or Surgical Wrench.

Ball Driver EV

Stainless steel (6)

Dalbo Plus

Female Part TE Basic, complete



Order No.	25834
-----------	-------

Lamellae retention Insert E



Order No.	25844
-----------	-------

Duplicating Aid



Order No.	25827
-----------	-------

Screwdriver/Activator



Order No.	25835
-----------	-------

Dalbo Plus Female Part Basic includes:

- Dalbo Plus attachment Titanium (2), non-sterile
- Lamellae retention Insert E Gold alloy (4), non-sterile
- Dalbo Plus Duplicating Aid Plastic (12), non-sterile

Dalbo Plus Screwdriver/Activator

Stainless steel (6), non-sterile

OD Cylinder



Uni 20°

Order No.	22182
-----------	-------



Uni 45°

Order No.	22183
-----------	-------

OD Cylinder

Gold Alloy (4)

Used with UniAbutment and bridge screw slot for bar solution.

- Compatible with most bar system on the market

SHORT FACTS

The following components should be utilized with UniAbutments (see page 22).



Surgical instruments

Getting started

If you are new to the Astra Tech Implant System, we recommend the following instruments to get started:

Surgical Instrument Kit, Order No. 24980 - see page 31

Surgical Tray, Order No. 24349 - see page 31

Ratchet Wrench, Order No. 24357 - see page 32

and your choice of:

Single Patient drills - see page 36

Multiple-use drills - see page 38



Surgical Instrument Kit



Order No.	24980
-----------	-------

Surgical Instrument Kit

Surgical Instrument Kit Includes:

Direction Indicator 2.0/3.2	(4 Pcs)	Order No. 22434
Implant Depth Gauge 6-19 mm	(1 Pc)	Order No. 24801
Implant Driver 3.5/4.0, Short	(1 Pc)	Order No. 25009
Implant Driver 3.5/4.0, Long	(1 Pc)	Order No. 25010
Implant Driver 4.5/5.0, Short	(1 Pc)	Order No. 25011
Implant Driver 4.5/5.0, Long	(1 Pc)	Order No. 25012
Hex CA Driver, Short	(1 Pc)	Order No. 22548
Hex CA Driver, Long	(1 Pc)	Order No. 22549
Drill Extension	(1 Pc)	Order No. 22520
Driver Handle	(1 Pc)	Order No. 24358

Note: Does not include implant drivers for 3.0 implant.

Surgical Tray

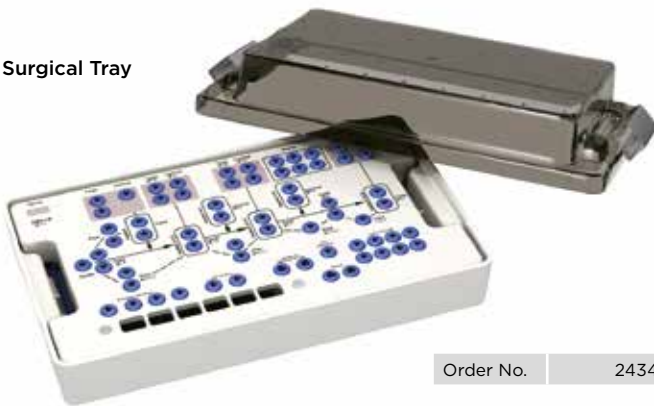

Order No.	24349
-----------	-------

Surgical Tray

No instruments included.

Implant Driver 3.0



	Short, 19 mm	Long, 28 mm
Order No.	25007	25008

Implant Driver 3.0

Stainless steel (6)

Implant Driver 3.5/4.0



	Short, 19 mm	Long, 28 mm
Order No.	25009	25010

Implant Driver 3.5/4.0

Stainless steel (6)

Implant Driver 4.5/5.0



	Short, 20 mm	Long, 28 mm
Order No.	25011	25012

Implant Driver 4.5/5.0

Stainless steel (6)

Used to engage and place implants.
Short drivers are ideal for the posterior region.

Ratchet Wrench

Stainless steel (6)

Wrench without torque function.

Ratchet Wrench



Order No.

24357

Driver Handle

Stainless steel (6)

Used in combination with Ratchet Wrench and/or machine/contra angle (CA) instruments.

Driver Handle



Order No.

24358

Wrench Adapter

Stainless steel (6)

For handling of Implant Drivers. Only needed for customers who already have Surgical Wrench (Order no 24178) or Torque Wrench (Order no 24075).

Wrench Adapter



Order No.

24572

Direction Indicator 2.0/3.2

Titanium (1)

For use after 2.0 mm and/or 3.2 mm Twist Drill.

Direction Indicator 2.0/3.2



Order No.

22434

Titanium Bowl

Titanium (1)

Titanium Bowl



Order No.

22137

Implant Depth Gauge, 6-19 mm

Titanium

Laser etched bands for measuring of implant and soft tissue heights. Waist at 13-15 mm indication.

Implant Depth Gauge, 6-19 mm



Order No.

24801

Wrench



Order No.	22124
-----------	-------

Wrench

Titanium (2)

Use together with any adapter and/or retriever.

Forceps



	94 mm
Order No.	22437

Forceps

Titanium (2)

Hex Screwdriver



	Short, 20 mm	Intermediate, 31 mm	Long, 43 mm
Order No.	22514	22515	22516

Hex Screwdriver

Stainless steel (6)

Hexagonal screwdriver.

Hex CA Driver



	Short, 22 mm	Short, 24 mm	Long, 35 mm
Order No.	25790	22548	22549

Hex CA Driver

Stainless steel (6)

Hexagonal screwdriver for Contra Angle and/or Driver Handle.

Surgical instruments

Osteotome Kit

Stainless steel (6)

Astra Tech Osteotome Kit includes:

Osteotome Tray, Large	(1)	22953
Osteotome Set, Round	(1)	22937
Osteotome Set, Concave	(1)	22947
Osteotome Mallet, Small	(1)	22955

Note: Does not include Osteotomes for 5.0 S implants.



Order No.	22956
-----------	-------

Osteotome Set, Round, Straight

Stainless steel (6)

Seven straight instruments with round tips.
Also available as separate items.

Osteotome 2.0/2.5, Round, Straight	(1)	22930
Osteotome 2.5/3.2, Round, Straight	(1)	22931
Osteotome 3.2, Round, Straight	(1)	22932
Osteotome 3.2/3.7, Round, Straight	(1)	22933
Osteotome 3.7, Round, Straight	(1)	22934
Osteotome 3.2/4.3, Round, Straight	(1)	22935
Osteotome 3.7/4.8, Round, Straight	(1)	22936

Note: Does not include Osteotomes for 5.0 S implants.



Order No.	22937
-----------	-------

Osteotome Set, Concave, Bayonet

Stainless steel (6)

Seven bayonet shaped instruments with concave tips. Also available as separate items.

Osteotome 2.0/2.5, Concave, Bayonet	(1)	22940
Osteotome 2.5/3.2, Concave, Bayonet	(1)	22941
Osteotome 3.2, Concave, Bayonet	(1)	22942
Osteotome 3.2/3.7, Concave, Bayonet	(1)	22943
Osteotome 3.7, Concave, Bayonet	(1)	22944
Osteotome 3.2/4.3, Concave, Bayonet	(1)	22945
Osteotome 3.7/4.8, Concave, Bayonet	(1)	22946

Note: Does not include Osteotomes for 5.0 S implants.



Order No.	22947
-----------	-------

Osteotome Mallet, Small

Stainless steel (6)



Order No.	22955
-----------	-------



Order No.	24687
-----------	-------

Osteotome Set 5.0 S, Round, Straight

Stainless steel (6)

Four straight instruments with round tips.
Also available as separate items.

Osteotome 3.7/4.2, Round, Straight	24339
Osteotome 4.2, Round, Straight	24684
Osteotome 4.2/4.7, Round, Straight	24685
Osteotome 4.7, Round, Straight	24686



Order No.	24692
-----------	-------

Osteotome Set 5.0 S, Concave, Bayonet

Stainless steel (6)

Four bayonet shaped instruments with concave tips. Also available as separate items.

Osteotome 3.7/4.2, Concave, Bayonet	24688
Osteotome 4.2, Concave, Bayonet	24689
Osteotome 4.2/4.7, Concave, Bayonet	24690
Osteotome 4.7, Concave, Bayonet	24691



Order No.	22953
-----------	-------

Osteotome Tray, Large

Stainless steel (6)

No instruments included.
Room for 14 osteotomes.



Order No.	24693
-----------	-------

Osteotome Tray, Small

Stainless steel (6)

No instruments included.
Room for 7 osteotomes.

Drills
Single Patient drills

Single Patient Drill Kits

Stainless steel (6), ABS Plastic (17)
 Sterile
 Laser etched depth indication.

Includes:
 Guide Drill
 SP Twist Drill Ø 2.0
 SP Twist Drill Ø 3.2

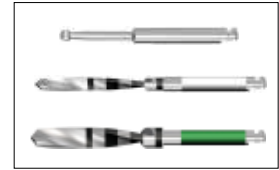

	Short, 8-13 mm	Long, 8-19 mm
Order No.	22898	22899

Single Patient Drill Kit 6-13 mm

Stainless steel (6), ABS Plastic (17)
 Sterile
 Laser etched depth indication.

Includes:
 SP Twist Drill Ø 2.0, 6-13 mm
 SP Twist Drill Ø 3.2, 6-13 mm

Note: SP Drills included in kits are not available as separate items.

*For OsseoSpeed TX 4.0 S - 6 mm













Order No.	24737*
-----------	--------

























Single Patient Drills

Stainless steel (6), ABS Plastic (17)
Sterile
Laser etched depth indication.

	Order No.	
SP Twist Drill Ø 3.7, 6-13 mm	24199*	
SP Twist Drill Ø 3.85, 6-13 mm	24734*	

	Order No.	Short 8-13 mm
SP Twist Drill Ø 2.0	24992	
SP Twist Drill Ø 2.7	24994	
SP Twist Drill Ø 2.85	24996	
SP Twist Drill Ø 3.35	22908	
SP Twist Drill Ø 3.7	22910	
SP Twist Drill Ø 3.85	22912	
SP Twist Drill Ø 4.2	22957	
SP Twist Drill Ø 4.7	22959	
SP Twist Drill Ø 4.85	22961	

	Order No.	Long 8-19 mm
	24991	
	24993	
	24995	
	22909	
	22911	
	22913	
	22958	
	22960	
	22962	

	Order No.	Short shaft
SP Pilot Drill Ø 2.0/3.2, 6-13 mm	24735*	
SP Pilot Drill Ø 2.0/2.7	24997	
SP Pilot Drill Ø 2.0/3.2	22904	
SP Pilot Drill Ø 3.2/3.7	22906	
SP Pilot Drill Ø 3.7/4.2	22963	
SP Cortical Drill Ø 2.7/3.0	24998	
SP Cortical Drill Ø 3.2/3.5	22914	
SP Cortical Drill Ø 3.7/4.0	22916	
SP Cortical Drill Ø 4.7/5.0	22964	
SP Conical Drill Ø 2.7/4.5	24999	
SP Conical Drill Ø 3.2/4.5	22921	
SP Conical Drill Ø 3.2/5.0	25001	
SP Conical Drill Ø 3.7/5.0	22923	

	Order No.	Long shaft
	22905	
	22907	
	22915	
	22917	
	25000	
	22922	
	25002	
	22924	

*For OsseoSpeed TX 4.0 S - 6 mm

Drills
Multiple-use drills

Guide Drill

Stainless steel (6), Non-sterile

Guide Drill Ø 1.8



Order No.	22800
-----------	-------

Twist Drill

Stainless steel (6), TiN-coated (8)





Non-sterile

Laser etched depth indication.

Note: *Not included in Drill Set, Order No. 24264

	Order No.	Short, 8-13 mm	Order No.	Long, 8-19 mm
Twist Drill Ø 2.0, (no color)	22887		22886	
Twist Drill Ø 2.5, (red)	22802		22801	
Twist Drill Ø 2.7, (light blue)	24797*		24796*	
Twist Drill Ø 2.85, (silver)	24799*		24798*	
Twist Drill Ø 3.2, (green)	22811		22807	
Twist Drill Ø 3.35, (lilac)	22812		22808	
Twist Drill Ø 3.7, (black)	22813		22809	
Twist Drill Ø 3.85, (brown)	22814		22810	
Twist Drill Ø 4.2, (yellow)	22463*		22462*	
Twist Drill Ø 4.7, (blue)	22465*		22464*	
Twist Drill Ø 4.85, (pink)	22467*		22466*	

Pilot Drill





	Order No.	
Pilot Drill Ø 2.0/2.7 (light blue)	24795*	
Pilot Drill Ø 2.0/3.2 (green)	24207	
Pilot Drill Ø 2.5/3.2 (green)	22803	
Pilot Drill Ø 3.2/3.7 (black)	22805	
Pilot Drill Ø 3.7/4.2 (yellow)	22468*	

Pilot Drill

Stainless steel (6), TiN-coated (8)
Non-sterile
Laser etched depth indication.

Note: *Not included in Drill Set,
Order No. 24264

Cortical Drill

	Order No.	
Cortical Drill Ø 2.7/3.0 (light blue)	24800*	
Cortical Drill Ø 3.2/3.5 (green)	22815	
Cortical Drill Ø 3.7/4.0 (black)	22816	
Cortical Drill Ø 4.7/5.0 (blue)	22469*	

Cortical Drill

Stainless steel (6), TiN-coated (8)
Non-sterile
Laser etched depth indication.









Note: *Not included in Drill Set,
Order No. 24264

Conical Drill

Stainless steel (6), TiN-coated (8)
Non-sterile
Laser etched depth indication.

Note: *Not included in Drill Set,
Order No. 24264

Conical Drill

	Order No.	Short shaft	Order No.	Long shaft
Conical Drill Ø 2.7/4.5 (light blue)	24924*		24925*	
Conical Drill Ø 3.2/4.5 (green)	22894		22895	
Conical Drill Ø 3.2/5.0 (no color)	24926*		24927*	
Conical Drill Ø 3.7/5.0 (black)	22896		22897	

Drill Extension



Order No.	22520

Drill Extension

Stainless steel (6)

Implant 900 Set

Set includes:

- Control unit
- Motor (1.8 m cable with 5 clips)
- Foot control
- Contra-angle WI-75 E/KM
- Irrigation set, disposable (3 pcs.)
- Accessories



Implant 900 Set SI-915, 120V

Order No.	26265
-----------	-------

Contra-angles

- Suitable for drills with internal and external irrigation
- WS-75 L G provides LED light from an in-built generator (LED > 300 rpm)



	20:1	20:1	20:1
Order No.	26273	26268	26269

Contra-angles and handpieces

- Can be dismantled, except WI-75 E/KM
- Also compatible with previous motors for Frios Unit S/i and Implant Unit SI
- Can be sterilized



	1:1	1:1
Order No.	26270	26271

Handpieces

- Mainly intended for general oral surgery procedures

Accessories

- Motor – 1.8 m cable with 5 clips
- Foot Control – 2.8 m cable
- Motor and Foot Control are not compatible with previous Frios Unit S/i or Implant Unit SI

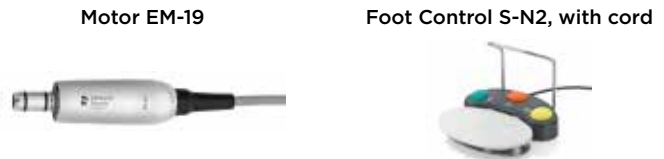

Order No.	26266	26267
-----------	-------	-------

Irrigation tubing and cover

Plastic, sterile

- Single-use
- Complete irrigation set for Implant 900, Frios Unit S/i & S and Implant Unit SI (with 1.8 m motor cable)
- Irrigation tubing extension, connected with Luer Lock
- Cover sleeve 240x7 cm, with latex-free elastic bands, for motor and cable

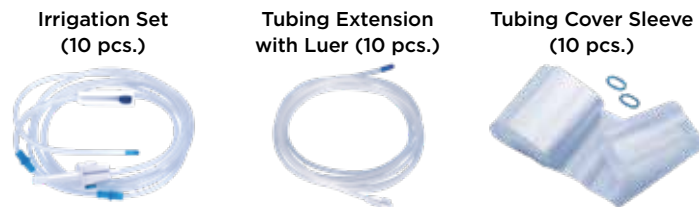

Order No.	24785	24786	24787
-----------	-------	-------	-------

Mucosal Punch EV



Ø	3.5	4	4.5	5	5.5	6.5
Order No.	25711	25712	25713	25714	25715	25731

Mucosal Punch EV

Stainless steel (6), ABS Plastic (17)
 Sterile
 Single use only
 QTY 5

BoneTrap™



Order No.	22179
-----------	-------

BoneTrap™

Plastic (12), sterile
 BoneTrap is the ideal collector for harvesting bone particles during surgery. The unique design of the filter allows for efficient collection of bone particles without clogging. BoneTrap is disposable and provided sterile.
 QTY 1

Restorative instruments

Getting started

If you are new to the Astra Tech Implant System, we recommend the following prosthetic instruments to get started:

Restorative Instrument Kit, Order No. 24879 - see page 43

Restorative Tray, Order No. 22495 - see page 43

Torque Wrench Kit, Order No. 24100 - see page 43



Restorative Instrument Kit



Order No.	24879
-----------	-------

Restorative Instrument Kit

Restorative Instrument Kit Includes:

Driver Handle	(1 Pc)	Order No. 24358
Abutment Depth Gauge	(1 Pc)	Order No. 24573
Hex CA Driver, short	(1 Pc)	Order No. 22548
Hex CA Driver, long	(1 Pc)	Order No. 22549

Restorative Tray



Order No.	22495
-----------	-------

Restorative Tray

Tray with room to host all restorative instruments. No instruments included.

Torque Wrench Kit

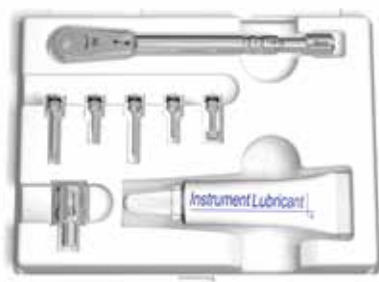

Order No.	24100
-----------	-------

Torque Wrench Kit

Wrench with adjustable torque function. Range 10, 15, 20 and 25 Ncm.

Torque Wrench	(1 Pc)	Order No. 24075
T.W. Bit Hex, Short	(1 Pc)	Order No. 24093
T.W. Bit Hex, Long	(1 Pc)	Order No. 24094
T.W. Bit Slot, Short	(1 Pc)	Order No. 24095
T.W. Bit Slot, Long	(1 Pc)	Order No. 24096
T.W. Conn., Adapter	(1 Pc)	Order No. 24097
T.W. Instrument Lubricant	(1 Pc)	Order No. 24098
T.W. Dismantle Tool	(1 Pc)	Order No. 24099

O-ring T.W. Bit (QTY 10) Order No. 22416

Torque Wrench
Stainless steel (6)

Torque Wrench



Order No.	24075
-----------	-------

Hex Screwdriver
Stainless steel (6)
Hexagonal screwdriver.

Hex Screwdriver



	Short, 20 mm	Intermediate, 31 mm	Long, 43 mm
Order No.	22514	22515	22516

Hex CA Driver
Stainless steel (6)
Hexagonal screwdriver
for Contra Angle.

Hex CA Driver



	Short, 22 mm	Short, 24 mm	Long, 35 mm
Order No.	25790	22548	22549

Slot Screwdriver



	Short, 20 mm	Intermediate, 30 mm	Long, 43 mm
Order No.	22506	22507	22508

Slot Screwdriver
Stainless steel (6)

Slot CA Driver



	Short, 24 mm	Long, 35 mm
Order No.	22688	22689

Slot CA Driver
Stainless steel (6)
Slot screwdriver for Contra Angle.

Abutment Depth Gauge



Order No.	24573
-----------	-------

Abutment Depth Gauge
Stainless steel (6)
Laser etched bands for measuring mucosal height over the implant in millimeters.
Waist at 4-5 mm indication, section for better visual orientation.

Handpiece Connector Carrier



Order No.	24133
-----------	-------

Handpiece Connector Carrier
Stainless steel (6)
For connection between Contra Angle and pre-mounted Abutment Carrier on UniAbutments.

Carrier Extension



	Short	Long
Order No.	24134	24135

Carrier Extension
Stainless steel (6)
For extended connection between pre-mounted Abutment Carrier and Torque Wrench.

O-ring (QTY 10) Order No. 22416

Lab Abutment Screw Design
Titanium (2)

For all DesignLine abutments.
Separate sets, each set includes:

- 2 pcs Yellow
- 6 pcs Aqua
- 6 pcs Lilac

Lab Abutment Screw Design



QTY	2 x M1.4	6 x M1.6	6 x M2
Order No.	24802	24857	24858

Lab Abutment Screw, Angled
Titanium (2)

For Angled Abutment.
Set includes 4 pieces:

- 2 pcs Aqua
- 2 pcs Lilac

Lab Abutment Screw, Angled



QTY	2 x M1.6	2 x M2
Order No.	24860	

Lab Bridge Screw, hex and slot
Titanium (2)

Set includes 6 pieces:
- 3 slot screws
- 3 hex screws

Lab Bridge Screw, hex and slot



QTY	3 x M1.4	3 x M1.4
Order No.	24859	

Grinding Handle

Use with implant replicas for grinding of abutments.

Grinding Device



Order No.	22740
-----------	-------

Grinding Device

Stainless steel (6)

For Cylinder 20° and Bridge Screw entrance hole.

Grinding Device



	Uni 20°	Cylinder, Bridge Hole
Order No.	22170	22820

Polishing Protector

Stainless steel (6), non-sterile

QTY 10

For the internal cone and the margin of 20° and 45° cylinders.
Works together with Bridge Screw or Abutment Guide Pin.

Polishing Protector



	Uni 20°	Uni 45°
Order No.	22471	22474

Repair and retrieval instruments

The Astra Tech Implant System provided a selection of unique products for safe and easy handling when meeting specific failures and other errors in the clinical situation. For different reasons abutments, implants or screws occasionally need to be removed and/or replaced. The specific repair and retrieval products are used together with the ordinary instruments within Astra Tech Implant System.









Compatibility table

Identify the implant/abutment size for OsseoSpeed TX assortment.

Select the corresponding instruments; see the order number in the table below.

Astra Tech Implant System®

	OsseoSpeed TX				OsseoSpeed TX Profile	20°/45° Uni Abutment
				 		
Fragment Fork	25856	25856	25856	25857	25857	25856
Fragment Drill	25858	25858	25858	25859	25859	25858
Screw Extractor	25860	25860	25861	25861	25861	
Thread Cleaner	25862	25863	25863	25865	25865	25862
Trephine Drill	25866	22884	22885	22890	22890	N/A
Retriever	22429	22192	22192	22192	22192	22429

Remove/retrieve screw fragments

Guiding Cylinder TX

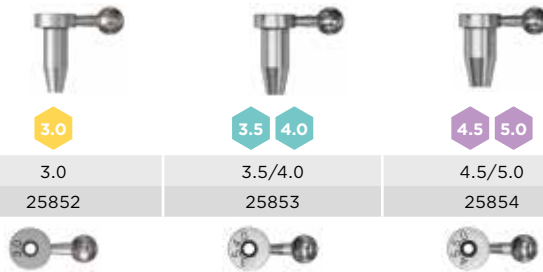

	3.0	3.5/4.0	4.5/5.0
Order No.	25852	25853	25854



Guiding Cylinder TX

Stainless steel (6), non-sterile, single-use only

- Guides the instruments into the center of the fragment
- Protects the internal threads in the implant
- Marked with diameter
- Use together with Guiding Cylinder Handle and Fragment Drill or Fragment Fork for OsseoSpeed TX implants

Guiding Cylinder UniAbutment 20°/45°



	20°	45°
Order No.	25884	25885



Guiding Cylinder UniAbutment 20°/45°

Stainless steel (6), non-sterile, single-use only

- Guides the instruments into the center of the fragment
- Protects the internal threads in the abutment
- Marked with diameter and TX
- Use together with Guiding Cylinder Handle and Guiding Fragment Drill or Fragment Fork for UniAbutment 20°/45° in Astra Tech Implant System

Guiding Cylinder Handle



Order No.	25855
-----------	-------

Guiding Cylinder Handle

Stainless steel (6), non-sterile

- Adjustable handle for Guiding Cylinders

Fragment Fork



∅	0.8	1.0
Order No.	25856	25857



	Thin	Wide
∅	1.0	1.4
Order No.	22122	22632

Fragment Fork

Tungsten-Carbide (9), non-sterile, single-use only

- Used for retrieval of fractured abutment- and bridge screws fragment
- For manual use only
- Rotate the Fragment Fork counter-clockwise
- Marked with thread size
- Use together with Restorative Driver Handle EV

Note: Manual use only.

Fragment Drill



∅	0.8	1.0
Order No.	25858	25859

Fragment Drill

Shank: Stainless steel (6)
Cutting portion: Tungsten-Carbide (9)
Non-sterile, single-use only

- Used for creating an indentation in the abutment- or bridge screw fragment
- Drill counter-clockwise
- Marked with diameter

Screw Extractor



∅	0.8	1.0
Order No.	25860	25861

Screw Extractor

Stainless steel (6), non-sterile, single-use only

- Used for retrieval of abutment screw fragments
- Rotate the screw extractor counter-clockwise
- Marked with diameter
- Use together with Surgical Driver Handle EV

Note: Manual use only.

Clean internal threads

Thread Cleaner

Stainless steel (6), non-sterile, single-use only.

- Used for cleaning of threads internally in an implant/abutment
- Marked with thread size
- Use together with Restorative Driver Handle EV

Note: Manual use only.

Thread Cleaner



	M1.4	M1.6	M1.8	M2.0
Order No.	25862	25863	25864	25865

Thread Taps

Stainless steel (6), non-sterile

To create new threads internally in a damaged implant/abutment.

- Used for cleaning of threads internally in an implant/abutment
- Used together with Driver Handle

Note: Manual use only.

Thread Taps



	M1.4	M1.6	M2.0
Order No.	22871	22873	22875

Remove UniAbutments/implants

Removal Tool M1.4



	Short	Long
Length	18	30
Order No.	24021	24037

Removal Tool M1.4

Stainless steel (6), non-sterile

- For removal of UniAbutment 20° and 45° with grooves and
- Use together with Ratchet Wrench/ Torque Wrench/Surgical Wrench or Wrench (22124)

Trepine Drill



	3.0*	3.5	4.0	4.5 5.0	
Inner Ø mm	6-17 mm	3.2	3.65	4.0	5.0
Outer Ø mm		4.0	4.5	5.1	6.15
Order No.	25866	22884	22885	22890	

*Note: Same drill for all 3.0 implants and single-use only.

Trepine Drill

Stainless steel (6), non-sterile

- Used for the retrieval of partly or fully integrated implants.
- Marked with diameter and length.

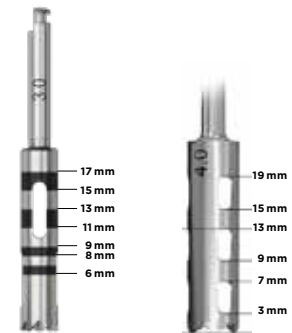

Abutment Retriever



Order No.	22429
-----------	-------

Abutment Retriever

Stainless steel (6), non-sterile, single-use only

- Use together with a Wrench.

Implant Retriever



Order No.	22192
-----------	-------

Implant Retriever

Stainless steel (6), non-sterile, single-use only

- Use together with a Wrench.

General instruments

Torque Wrench EV

Stainless steel (6), non-sterile

- Use together with a driver handle.

Torque Wrench EV



Order No.	25774
-----------	-------

Torque Wrench EV, Surgical Driver Handle

Stainless steel (6), non-sterile

Torque Wrench EV, Restorative Driver Handle

Stainless steel (6), non-sterile

Torque Wrench EV, Restorative Driver Handle 4x4 low

Stainless steel (6), non-sterile

Torque Wrench EV, Surgical Driver Handle



Ø mm	8.9
Length mm	15.3
Order No.	25775

Torque Wrench EV, Restorative Driver Handle



Ø mm	8.9	8.9
Length mm	15.5	11.5
Order No.	25776	25777

Torque Wrench EV, Restorative Driver Handle 4x4 low



Ø mm	8.9
Length mm	9.7
Order No.	25730

Hex Driver EV Manual

Stainless steel (6), non-sterile

Hex Driver Manual

Stainless steel (6), non-sterile

Hex Driver Manual



	Short	Short	Intermediate	Intermediate	Long	Long
Total length mm	20	20	31	31	38	43
Order No.	25771	22514	25772	22515	25773	22516

Wrench

Titanium (2), non-sterile

- Use together with an adapter and/or retriever.

Wrench



Order No.	22124
-----------	-------

For removal of abutments without drivers

Abutment Adapter

Titanium (2) and Stainless steel (6)

For removal of 20° and 45° UniAbutment **without** grooves.

Used together with Ratchet Wrench/ Torque Wrench/Surgical Wrench or Wrench 22124.

O-ring, Abutment Adapter, Plastic (QTY 10) Order No. 22376









Abutment Adapter



	Short	Long
Length mm	25	35
Order No.	24424	24370

Torque guide

Recommended tightening torque

Type of product		Torque - Ncm		
		X-Small	Small	Large
Cover Screw		Manual*	Manual*	Manual*
Healing Abutment Healing Abutment Uni ProHeal Cap Healing Cap Angled		Manual**	Manual**	Manual**
TempDesign™		-	15	15
Temporary Abutment		15	15	15
20°/45° UniAbutment		-	15	15
Bridge Screws		-	15	15
Atlantis® abutment for Astra Tech Implant System® ZirDesign™ TiDesign™ CastDesign™ Angled Abutment		15***	20	25
Direct Abutment™ Ball Abutment Locator™ Abutment		-	25	25

* Only light fingerforce (5-10 Ncm) using a manual screwdriver or contra angle preset at 25 rpm and 5-10 Ncm torque.

** Only light fingerforce (5-10 Ncm) using a manual screwdriver. Do not use a Ratchet Wrench or Torque Wrench.

*** **Note:** Available for TiDesign, Atlantis abutment, titanium and Atlantis abutment, GoldHue.

Material specifications

Index (x) will be found at material description for specific products.

Metals

Type	Index	Composition/Designation	Standard
Titanium	1	Commercially pure titanium Grade 1-4	ASTM F67
Titanium alloy	2	Ti6Al4V Grade 5	ASTM F136
Gold-Platinum alloy	3	Au 60%, Pd 20%, Pt 19%, Ir 1%	
Gold alloy	4	Au 68.6%, Ag 11.85%, Cu 10.6%, Pd 3.95%, Zn 2.5%, Pt 2.45%, Ir 0.05% T _s - T _L 880-940°C	
Gold alloy, Valor	5	Pt 89.0%, Au 10.0%, Ir 1.0% T _s - T _L 1660-1710°C	
Stainless steel	6	Surgical stainless steel	ASTM F899
Aluminum	7	6061 T6	
TiN Coating	8	Titanium Nitride	
Tungsten-Carbide	9	Sandvik H 10F	ISO 4499









Plastic







Type	Index	Composition/Designation	Standard
PEEK	10	Polyetereterketon	
Burnout plastic, PMMA	11	Polymethylmetakrylat	ISO 8257 MN, 100-060
PC plastic	12	Polycarbonate	
PP plastic	13	Polypropylene	
PPSU plastic	14	Polyphenylsulfone	
Silicone	15	Polysiloxanes	
Nylon	16	Polyamid	
ABS Lustran 348	17	Acrylonitrile butadiene styrene	

Ceramic

Type	Index	Composition/Designation	Standard
Zirconia	18	ZrO ₂	

Explanation of the symbols on labels and instructions for use

Symbol	Text
 Date of manufacture	Date of manufacture.
	Legal manufacturer
 Use by	Expired date.
	Sterilized using irradiation.
	Caution: Federal (USA) law restricts this product to sale by or on a order of a dentist.
	The product is not sterile.
 Single use	Do not re-use, Single use only.
 Do not re-sterilize	Do not re-sterilize.
	GOST is the valid quality certification system in Russian Federation.

Symbol	Text
	Products carrying the CE mark fulfill the requirements of the Medical Device Directive.
0123	Identification of Notified Body.
 Do not use if package is damaged	Do not use if package is damaged.
 For instructions for use and symbols glossary refer to ifu.dentsplysirona.com	Consult instructions for use.*
	Consult instructions for use.
	LOT/BATCH number.
	Article number.
	Contains article number (GTIN number), lot number and quantity.

* To read PDF files you will need Adobe Reader. Download free of charge at get.adobe.com/reader.

Patient information material

It is important to inform your patients about the option of dental implant treatment and the many benefits that it can provide. To support you, we offer a selection of patient information material. For further information please ask your local representative or visit www.dentsplyimplants.com.

Order by reference number

Order No.	page	Order No.	page
22054	Direct Abutment™ 4 Replica.....	20	
22060	Temporary Cylinder Uni 20°	25	
22061	Temporary Cylinder Uni 45°	25	
22064	Direct Abutment™ 5 Replica.....	20	
22065	Direct Abutment™ 6 Replica.....	20	
22068	20°/45° UniAbutment Transfer	24	
22069	Abutment Replica Uni 20°	24	
22070	Abutment Replica Uni 45°	24	
22122	Fragment Fork, Thin, Ø 0.8.....	49	
22124	Wrench	33, 52	
22137	Titanium Bowl	32	
22167	Bridge Screw Slot	25	
22170	Grinding Device Uni 20°	46	
22179	BoneTrap™.....	41	
22182	OD Cylinder Uni 20°	29	
22183	OD Cylinder Uni 45°	29	
22184	Semi-Burnout Cylinder Uni 20°	25	
22185	Semi-Burnout Cylinder Uni 45°	25	
22186	Burnout Cylinder Uni 20°	25	
22187	Burnout Cylinder Uni 45°	25	
22190	Abutment Guide Pin - 13 mm	24	
22192	Implant Retriever	51	
22197	Abutment Guide Pin - 16 mm	24	
22198	Abutment Guide Pin - 19 mm	24	
22199	Abutment Guide Pin - 22 mm	24	
22372	Direct Abutment™ 4 Burnout Cylinder.....	20	
22373	Direct Abutment™ 5 Burnout Cylinder.....	20	
22376	O-ring, Abutment Adapter, Plastic	52	
22379	Direct Abutment™ 6 Burnout Cylinder.....	20	
22416	O-ring, Carrier Extension	43, 45	
22429	Abutment Retriever	51	
22434	Direction Indicator 2.0/3.2	32	
22435	Bridge Screw Hex	25	
22437	Forceps - 94 mm	33	
22439	Ball Abutment Pick-up	29	
22447	Temporary Cylinder Angled	25	
22448	Burnout Cylinder Angled	25	
22462	Twist Drill Ø 4.2, 8-19 mm (yellow) Long.....	38	
22463	Twist Drill Ø 4.2, 8-13 mm (yellow) Short.....	38	
22464	Twist Drill Ø 4.7, 8-19 mm (blue) Long.....	38	
22465	Twist Drill Ø 4.7, 8-13 mm (blue) Short.....	38	
22466	Twist Drill Ø 4.85, 8-19 mm (pink) Long.....	38	
22467	Twist Drill Ø 4.85, 8-13 mm (pink) Short.....	38	
22468	Pilot Drill Ø 3.7/4.2 (yellow) Short	38	
22469	Cortical Drill Ø 4.7/5.0 (blue) Short	38	
22471	Polishing Protector Uni 20°	46	
22474	Polishing Protector Uni 45°	46	
22487	Abutment Screw Angled 4.5/5.0 - M2	23	
22495	Restorative Tray	43	
22505	Ball Abutment Replica	29	
22506	Slot Screwdriver - Short	45	
22507	Slot Screwdriver - Intermediate	45	
22508	Slot Screwdriver - Long	45	
22514	Hex Screwdriver - Short	33, 44, 52	
22515	Hex Screwdriver - Intermediate	33, 44, 52	
22516	Hex Screwdriver - Long	33, 44, 52	
22520	Drill Extension	39	
22548	Hex CA Driver - Short	33, 44	
22549	Hex CA Driver - Long	33, 44	
22632	Fragment Fork, Wide, Ø 1.4.....	49	
22688	Slot CA Driver - Short	45	
22689	Slot CA Driver - Long	45	
22710	Direct Abutment™ 4 Impression Pick-up.....	20	
22711	Direct Abutment™ 5 Impression Pick-up.....	20	
22712	Direct Abutment™ 6 Impression Pick-up.....	20	
22720	Direct Abutment™ 4 Healing Cap.....	20	
22721	Direct Abutment™ 5 Healing Cap.....	20	
22722	Direct Abutment™ 6 Healing Cap.....	20	
22740	Grinding Handle	46	
22798	Titanium Cylinder Uni 20°	25	
22799	Titanium Cylinder Uni 45°	25	
22800	Guide Drill Ø 1.8	38	
22801	Twist Drill Ø 2.5, 8-19 mm (red) Long	38	
22802	Twist Drill Ø 2.5, 8-13 mm (red) Short	38	
22803	Pilot Drill Ø 2.5/3.2 (green) Short	39	
22805	Pilot Drill Ø 3.2/3.7 (black) Short	39	
22807	Twist Drill Ø 3.2, 8-19 mm (green) Long	38	
22808	Twist Drill Ø 3.35, 8-19 mm (lilac) Long	38	
22809	Twist Drill Ø 3.7, 8-19 mm (black) Long	38	
22810	Twist Drill Ø 3.85, 8-19 mm (brown) Long	38	
22811	Twist Drill Ø 3.2, 8-13 mm (green) Short	38	
22812	Twist Drill Ø 3.35, 8-13 mm (lilac) Short	38	
22813	Twist Drill Ø 3.7, 8-13 mm (black) Short	38	
22814	Twist Drill Ø 3.85, 8-13 mm (brown) Short	38	
22815	Cortical Drill Ø 3.2/3.5 (green) Short.....	39	
22816	Cortical Drill Ø 3.7/4.0 (black) Short	39	
22820	Grinding Device Cylinder, Bridge Hole	46	
22843	CastDesign™ 3.5/4.0	17	
22844	CastDesign™ 4.5/5.0.....	17	
22850	DA 4 Metal Carrier	20	
22851	TempDesign™ 3.5/4.0.....	14	
22852	TempDesign™ 4.5/5.0.....	14	
22853	TempDesign™ 3.5/4.0 NI	14	
22854	TempDesign™ 4.5/5.0 NI	14	
22871	Thread Tap, 1.4 mm.....	50	
22873	Thread Tap, 1.6 mm.....	50	
22875	Thread Tap, 2.0 mm.....	50	
22876	20° UniAbutment Pick-up Ø 5.5	24	
22878	45° UniAbutment Pick-up Ø 5.5	24	
22882	20° UniAbutment Pick-up Ø 4.3	24	
22883	45° UniAbutment Pick-up Ø 4.3	24	
22884	Trephine Drill, Ø 3.5.....	51	
22885	Trephine Drill, Ø 4.0.....	51	
22886	Twist Drill Ø 2.0, 8-19 mm (no color) Long.....	38	
22887	Twist Drill Ø 2.0, 8-13 mm (no color) Short	38	
22890	Trephine Drill, Ø 5.0.....	51	

Order No.		page
22894	Conical Drill Ø 4.5 (green) Short	39
22895	Conical Drill Ø 4.5 (green) Long	39
22896	Conical Drill Ø 5.0 (black) Short	39
22897	Conical Drill Ø 5.0 (black) Long	39
22898	SP Drill Kit, Short	36
22899	SP Drill Kit, Long	36
22904	SP Pilot Drill Ø 2.0/3.2 Short	36
22905	SP Pilot Drill Ø 2.0/3.2 Long	36
22906	SP Pilot Drill Ø 3.2/3.7 Short	36
22907	SP Pilot Drill Ø 3.2/3.7 Long	36
22908	SP Twist Drill Ø 3.35, 8-13 mm Short	36
22909	SP Twist Drill Ø 3.35, 8-19 mm Long	36
22910	SP Twist Drill Ø 3.7, 8-13 mm Short	36
22911	SP Twist Drill Ø 3.7, 8-19 mm Long	36
22912	SP Twist Drill Ø 3.85, 8-13 mm Short	36
22913	SP Twist Drill Ø 3.85, 8-19 mm Long	36
22914	SP Cortical Drill Ø 3.2/3.5 Short	36
22915	SP Cortical Drill Ø 3.5 Long	36
22916	SP Cortical Drill Ø 3.7/4.0 Short	36
22917	SP Cortical Drill Ø 4.0 Long	36
22921	SP Conical Drill Ø 3.2/4.5 Short	36
22922	SP Conical Drill Ø 4.5 Long	36
22923	SP Conical Drill Ø 3.7/5.0 Short	36
22924	SP Conical Drill Ø 5.0 Long	36
22930	Osteotome 2.0/2.5, Round, Straight	34
22931	Osteotome 2.5/3.2, Round, Straight	34
22932	Osteotome 3.2, Round, Straight	34
22933	Osteotome 3.2/3.7, Round, Straight	34
22934	Osteotome 3.7, Round, Straight	34
22935	Osteotome 3.2/4.3, Round, Conical, Straight	34
22936	Osteotome 3.7/4.8, Round, Conical, Straight	34
22937	Osteotome Set, Round	34
22940	Osteotome 2.0/2.5, Concave, Bayonet	34
22941	Osteotome 2.5/3.2, Concave, Bayonet	34
22942	Osteotome 3.2, Concave, Bayonet	34
22943	Osteotome 3.2/3.7, Concave, Bayonet	34
22944	Osteotome 3.7, Concave, Bayonet	34
22945	Osteotome 3.2/4.3, Concave, Conical, Bayonet	34
22946	Osteotome 3.7/4.8, Concave, Conical, Bayonet	34
22947	Osteotome Set, Concave	34
22953	Osteotome Tray, Large	35
22955	Osteotome Mallet, Small	34
22956	Osteotome Kit	34
22957	SP Twist Drill Ø 4.2, 8-13 mm Short	36
22958	SP Twist Drill Ø 4.2, 8-19 mm Long	36
22959	SP Twist Drill Ø 4.7, 8-13 mm Short	36
22960	SP Twist Drill Ø 4.7, 8-19 mm Long	36
22961	SP Twist Drill Ø 4.85, 8-13 mm Short	36
22962	SP Twist Drill Ø 4.85, 8-19 mm Long	36
22963	SP Pilot Drill Ø 3.7/4.2 Short	36
22964	SP Cortical Drill Ø 4.7/5.0 Short	36
24021	Removal Tool M1.4 - Short	51
24037	Removal Tool M1.4 - Long	51
24075	Torque Wrench	44
24092	Healing Cap, Angled Ø 5 - 7.5 mm	23
24093	Torque Wrench Bit Hex, Short	43
24094	Torque Wrench Bit Hex, Long	43
24095	Torque Wrench Bit Slot, Short	43
24096	Torque Wrench Bit Slot, Long	43
24097	Torque Wrench Connector, Adapter	41
24098	Torque Wrench Instrument Lubricant	43
24099	Torque Wrench Dismantle Tool	43
24100	Torque Wrench Kit	43
24133	Handpiece Connector Carrier	45
24134	Carrier Extension - Short	45
24135	Carrier Extension - Long	45
24137	Direct Abutment™ 4 Carrier	20
24138	Direct Abutment™ 5 Carrier	20
24139	Direct Abutment™ 6 Carrier	20
24158	20° ProHeal Cap Short Ø 5.5 - 3.8 mm	23
24159	20° ProHeal Cap Long Ø 5.5 - 5.8 mm	23
24160	45° ProHeal Cap Short Ø 5.5 - 3.8 mm	23
24161	45° ProHeal Cap Long Ø 5.5 - 5.8 mm	23

Order No.		page
24162	20° ProHeal Cap Short Ø 4.3 - 4 mm	23
24163	45° ProHeal Cap Short Ø 4.3 - 2.7 mm	23
24189	Abutment Screw 3.0 - M1.4	14, 16
24198	Cover Screw 3.0 - 0 mm	12
24199	SP Twist Drill Ø 3.7, 6-13 mm	39
24207	Pilot Drill Ø 2.0/3.2 mm, Green	39
24209	Abutment Screw Design 4.5/5.0 - M2	14, 16, 17
24227	Abutment Replica Angled	24
24235	TiDesign™ 4.5/5.0 - Ø 5.5, 1.5 mm	17
24236	TiDesign™ 4.5/5.0 - Ø 5.5, 3 mm	17
24237	TiDesign™ 4.5/5.0 - Ø 6.5, 1.5 mm	17
24238	TiDesign™ 4.5/5.0 - Ø 6.5, 3 mm	17
24239	TiDesign™ 4.5/5.0 - Ø 5.5, 20°	17
24243	Semi-Burnout Cylinder Angled	25
24244	Titanium Cylinder Angled	25
24245	Angled Abutment 3.5/4.0 - 0.8 mm	23
24246	Angled Abutment 3.5/4.0 - 2 mm	23
24247	Angled Abutment 4.5/5.0 - 0.8 mm	23
24248	Angled Abutment 4.5/5.0 - 2 mm	23
24254	Angled Abutment Pick-up	24
24268	Locator™ Abutment 3.5/4.0 - Ø 3.7, 1 mm	27
24269	Locator™ Abutment 3.5/4.0 - Ø 3.7, 2 mm	27
24270	Locator™ Abutment 3.5/4.0 - Ø 3.7, 3 mm	27
24271	Locator™ Abutment 3.5/4.0 - Ø 3.7, 4 mm	27
24272	Locator™ Abutment 3.5/4.0 - Ø 3.7, 5 mm	27
24280	Temporary Abutment 3.5/4.0 NI	14
24281	Temporary Abutment 3.5/4.0	14
24285	TiDesign™ 3.5/4.0 - Ø 4.5, 1.5 mm	17
24286	TiDesign™ 3.5/4.0 - Ø 4.5, 3 mm	17
24287	TiDesign™ 3.5/4.0 - Ø 5.5, 1.5 mm	17
24288	TiDesign™ 3.5/4.0 - Ø 5.5, 3 mm	17
24289	TiDesign™ 3.5/4.0 - Ø 6.5, 1.5 mm	17
24290	TiDesign™ 3.5/4.0 - Ø 6.5, 3 mm	17
24291	TiDesign™ 3.5/4.0 - Ø 4.5, 20°	17
24292	TiDesign™ 3.5/4.0 - Ø 5.5, 20°	19
24328	Cover Screw 3.5/4.0 - 0 mm	12
24329	Cover Screw 3.5/4.0 - 1 mm	12
24339	Osteotome 3.7/4.2, Round, Straight	35
24347	Angled Abutment 3.5/4.0 NI - 0.8 mm	23
24348	Angled Abutment 3.5/4.0 NI - 2 mm	23
24349	Surgical Tray	32
24357	Ratchet Wrench	32
24358	Driver Handle	32
24367	Ball Wrench	29
24370	Abutment Adapter - Long	52
24374	Healing Abutment Uni 3.5/4.0 - 2 mm	12
24375	Healing Abutment Uni 3.5/4.0 - 4 mm	12
24376	Healing Abutment Uni 3.5/4.0 - 6 mm	12
24377	Healing Abutment Uni 3.5/4.0 - 8 mm	12
24378	Healing Abutment Uni 3.5/4.0 - 10 mm	12
24379	Healing Abutment Uni 4.5/5.0 - 2 mm	12
24380	Healing Abutment Uni 4.5/5.0 - 4 mm	12
24381	Healing Abutment Uni 4.5/5.0 - 6 mm	12
24382	Healing Abutment Uni 4.5/5.0 - 8 mm	12
24383	Healing Abutment Uni 4.5/5.0 - 10 mm	12
24398	20° UniAbutment 4.5/5.0 - 0.5 mm	22
24399	20° UniAbutment 4.5/5.0 - 1 mm	22
24400	20° UniAbutment 4.5/5.0 - 2 mm	22
24401	20° UniAbutment 4.5/5.0 - 4 mm	22
24402	20° UniAbutment 4.5/5.0 - 6 mm	22
24403	20° UniAbutment 4.5/5.0 - 8 mm	22
24406	45° UniAbutment 4.5/5.0 - 0.5 mm	22
24407	45° UniAbutment 4.5/5.0 - 1 mm	22
24408	45° UniAbutment 4.5/5.0 - 2 mm	22
24409	45° UniAbutment 4.5/5.0 - 4 mm	22
24410	45° UniAbutment 4.5/5.0 - 6 mm	22
24411	45° UniAbutment 4.5/5.0 - 8 mm	22
24418	Ball Abutment 4.5/5.0 - 0.5 mm	28
24419	Ball Abutment 4.5/5.0 - 1 mm	28
24420	Ball Abutment 4.5/5.0 - 2 mm	28
24421	Ball Abutment 4.5/5.0 - 4 mm	28
24422	Ball Abutment 4.5/5.0 - 6 mm	28
24423	Ball Abutment 4.5/5.0 - 8 mm	28

Order No.	page	Order No.	page		
24424	Abutment Adapter - Short	52	24734	SP Twist Drill Ø 3.85, 6-13 mm	36
24439	Abutment Screw Angled 3.5/4.0 - M1.6	23	24735	SP Pilot Drill Ø 2.0/3.2, 6-13 mm.....	36
24447	Cover Screw 4.5/5.0 - 0 mm	12	24737	SP Drill Kit 6-13 mm	36
24448	Cover Screw 4.5/5.0 - 1 mm	12	24777	Healing Abutment 3.0 - Ø 4, 2 mm.....	13
24449	Abutment Screw Design 3.5/4.0 - M1.6	14, 16, 17	24778	Healing Abutment 3.0 - Ø 4, 4 mm.....	13
24477	Locator™ Abutment 4.5/5.0 - Ø 4.0, 0.5 mm	27	24785	Irrigation Set.....	50
24478	Locator™ Abutment 4.5/5.0 - Ø 4.0, 2 mm	27	24786	Tubing Extension with Luer	50
24479	Locator™ Abutment 4.5/5.0 - Ø 4.0, 3 mm	27	24787	Tubing Cover Sleeve.....	50
24480	Locator™ Abutment 4.5/5.0 - Ø 4.0, 4 mm	27	24788	TiDesign™ 3.0 - Ø 4.0, 1 mm	16
24481	Locator™ Abutment 4.5/5.0 - Ø 4.0, 5 mm	27	24789	TiDesign™ 3.0 - Ø 4.0, 2 mm	16
24482	Locator™ Core Tool	28	24790	TiDesign™ 3.0 - Ø 4.0, 15° mm	16
24483	Locator™ Process Kit	27	24795	Pilot Drill Ø 2.0/2.7 (light blue).....	39
24484	Locator™ Abutment Pick-up	27	24796	Twist Drill Ø 2.7, 8-19 mm (light blue) Long.....	38
24485	Locator™ Abutment Replica	27	24797	Twist Drill Ø 2.7, 8-13 mm (light blue) Short.....	37
24486	Locator™ Insert Male Clear	27	24798	Twist Drill Ø 2.85, 8-19 mm (silver) Long.....	37
24487	Locator™ Insert Male Pink	27	24799	Twist Drill Ø 2.85, 8-13 mm (silver) Short.....	37
24488	Locator™ Insert Male Blue	27	24800	Cortical Drill Ø 2.7/3.0 (light blue) Short.....	37
24489	Locator™ Insert Extended Range Male Green	27	24801	Implant Depth Gauge, 6-19 mm	32
24490	Locator™ Torque Wrench Bit - 15 mm	28	24802	Lab Abutment Screw Design 3.0.....	46
24491	Locator™ Torque Wrench Bit - 21 mm	28	24857	Lab Abutment Screw Design 3.5/4.0.....	46
24492	Locator™ Insert Extended Range Male Red	27	24858	Lab Abutment Screw Design 4.5/5.0	46
24527	Direct Abutment™ 4.5/5.0 - Ø 5, 0.5 mm.....	20	24859	Lab bridge screw, hex and slot.....	46
24528	Direct Abutment™ 4.5/5.0 - Ø 5, 1 mm.....	20	24860	Lab Abutment Screw, Angled.....	46
24529	Direct Abutment™ 4.5/5.0 - Ø 5, 2.5 mm.....	20	24879	Restorative Instrument Kit.....	43
24530	Direct Abutment™ 4.5/5.0 - Ø 5, 4 mm.....	20	24892	Radiographic Implant Guides.....	11
24537	Direct Abutment™ 4.5/5.0 - Ø 6, 1 mm.....	20	24893	20° UniAbutment 3.5/4.0 - 0.5 mm	22
24538	Direct Abutment™ 4.5/5.0 - Ø 6, 2.5 mm.....	20	24894	20° UniAbutment 3.5/4.0 - 1 mm	22
24539	Direct Abutment™ 4.5/5.0 - Ø 6, 4 mm.....	20	24895	20° UniAbutment 3.5/4.0 - 2 mm	22
24558	Direct Abutment API™ 4.5/5.0 - Ø 5, 0.5 mm	19	24896	20° UniAbutment 3.5/4.0 - 4 mm	22
24559	Direct Abutment API™ 4.5/5.0 - Ø 5, 1 mm	19	24897	20° UniAbutment 3.5/4.0 - 6 mm	22
24560	Direct Abutment API™ 4.5/5.0 - Ø 5, 2.5 mm	19	24898	20° UniAbutment 3.5/4.0 - 8 mm	22
24561	Direct Abutment API™ 4.5/5.0 - Ø 5, 4 mm	19	24899	45° UniAbutment 3.5/4.0 - 0.5 mm	22
24562	Direct Abutment API™ 4.5/5.0 - Ø 6, 1 mm	19	24900	45° UniAbutment 3.5/4.0 - 1 mm	22
24563	Direct Abutment API™ 4.5/5.0 - Ø 6, 2.5 mm	19	24901	45° UniAbutment 3.5/4.0 - 2 mm	22
24564	Direct Abutment API™ 4.5/5.0 - Ø 6, 4 mm	19	24902	45° UniAbutment 3.5/4.0 - 4 mm	22
24572	Wrench Adapter	32	24903	45° UniAbutment 3.5/4.0 - 6 mm	22
24573	Abutment Depth Gauge	45	24904	45° UniAbutment 3.5/4.0 - 8 mm	22
24574	Healing Abutment 3.5/4.0 - Ø 4, 2 mm	13	24905	Ball Abutment 3.5/4.0 - 1 mm	28
24575	Healing Abutment 3.5/4.0 - Ø 4.5, 4 mm	13	24906	Ball Abutment 3.5/4.0 - 2 mm	28
24576	Healing Abutment 3.5/4.0 - Ø 4.5, 6 mm	13	24907	Ball Abutment 3.5/4.0 - 4 mm	28
24577	Healing Abutment 3.5/4.0 - Ø 5.5, 2 mm	13	24908	Ball Abutment 3.5/4.0 - 6 mm	28
24578	Healing Abutment 3.5/4.0 - Ø 5.5, 4 mm	13	24909	Ball Abutment 3.5/4.0 - 8 mm	28
24579	Healing Abutment 3.5/4.0 - Ø 5.5, 6 mm	13	24910	Direct Abutment™ 3.5/4.0 - Ø 4, 0.5 mm.....	20
24580	Healing Abutment 3.5/4.0 - Ø 6.5, 4 mm	13	24911	Direct Abutment™ 3.5/4.0 - Ø 4, 1 mm.....	20
24581	Healing Abutment 3.5/4.0 - Ø 6.5, 6 mm	13	24912	Direct Abutment™ 3.5/4.0 - Ø 4, 2.5 mm.....	20
24582	Healing Abutment 4.5/5.0 - Ø 5.5, 2 mm	13	24913	Direct Abutment™ 3.5/4.0 - Ø 4, 4 mm.....	20
24583	Healing Abutment 4.5/5.0 - Ø 5.5, 4 mm	13	24914	Direct Abutment™ 3.5/4.0 - Ø 5, 1 mm.....	20
24584	Healing Abutment 4.5/5.0 - Ø 5.5, 6 mm	13	24915	Direct Abutment™ 3.5/4.0 - Ø 5, 2.5 mm.....	20
24585	Healing Abutment 4.5/5.0 - Ø 6.5, 2 mm	13	24916	Direct Abutment™ 3.5/4.0 - Ø 5, 4 mm.....	20
24586	Healing Abutment 4.5/5.0 - Ø 6.5, 4 mm	13	24917	Direct Abutment API™ 3.5/4.0 - Ø 4, 0.5 mm	19
24587	Healing Abutment 4.5/5.0 - Ø 6.5, 6 mm	13	24918	Direct Abutment API™ 3.5/4.0 - Ø 4, 1 mm	19
24606	Angled Abutment 4.5/5.0 NI - 0.5 mm	23	24919	Direct Abutment API™ 3.5/4.0 - Ø 4, 2.5 mm	19
24607	Angled Abutment 4.5/5.0 NI - 2 mm	23	24920	Direct Abutment API™ 3.5/4.0 - Ø 4, 4 mm	19
24684	Osteotome 4.2, Round, Straight	35	24921	Direct Abutment API™ 3.5/4.0 - Ø 5, 1 mm	19
24685	Osteotome 4.2/4.7, Round, Straight.....	35	24922	Direct Abutment API™ 3.5/4.0 - Ø 5, 2.5 mm	19
24686	Osteotome 4.7, Round, Straight	35	24923	Direct Abutment API™ 3.5/4.0 - Ø 5, 4 mm	19
24687	Osteotome Set 5.0 S, Round.....	35	24924	Conical Drill Ø 2.7/4.5 (light blue) Short.....	39
24688	Osteotome 3.7/4.2, Concave, Bayonet.....	35	24925	Conical Drill Ø 2.7/4.5 (light blue) Long.....	39
24689	Osteotome 4.2, Concave, Bayonet.....	35	24926	Conical Drill Ø 3.2/5.0 (no color) Short.....	39
24690	Osteotome 4.2/4.7, Concave, Bayonet.....	35	24927	Conical Drill Ø 3.2/5.0 (no color) Long	39
24691	Osteotome 4.7, Concave, Bayonet.....	35	24928	Implant Pick-up 4.5/5.0 NI - Short	18
24692	Osteotome Set 5.0 S, Concave.....	35	24929	Implant Pick-up 4.5/5.0 NI - Long	18
24693	Osteotome Tray, Small	35	24930	OsseoSpeed® TX 3.5 S - 8 mm	10
24702	ZirDesign™ 3.5/4.0 - Ø 4.4, 1.5 mm	16	24931	OsseoSpeed® TX 3.5 S - 9 mm	10
24703	ZirDesign™ 3.5/4.0 - Ø 4.5, 3 mm	16	24932	OsseoSpeed® TX 3.5 S - 11 mm	10
24704	ZirDesign™ 3.5/4.0 - Ø 5.5, 1.5 mm	16	24933	OsseoSpeed® TX 3.5 S - 13 mm	10
24705	ZirDesign™ 3.5/4.0 - Ø 5.5, 3 mm	16	24934	OsseoSpeed® TX 3.5 S - 15 mm	10
24706	ZirDesign™ 3.5/4.0 - Ø 5.5, 3.5 mm, 20°	16	24935	OsseoSpeed® TX 3.5 S - 17 mm	10
24707	ZirDesign™ 4.5/5.0 - Ø 5.5, 1.5 mm	16	24936	Implant Pick-up 3.5/4.0 NI - Short	18
24708	ZirDesign™ 4.5/5.0 - Ø 5.5, 3 mm	16	24937	Implant Pick-up 3.5/4.0 NI - Long	18
24709	ZirDesign™ 4.5/5.0 - Ø 6.5, 1.5 mm	16	24938	Implant Pick-up 4.5/5.0 - Short	18
24710	ZirDesign™ 4.5/5.0 - Ø 6.5, 3 mm	16	24939	OsseoSpeed® TX 4.0 S - 6 mm	10
24711	ZirDesign™ 4.5/5.0 - Ø 5.5, 3.5 mm, 20°	16	24940	OsseoSpeed® TX 4.0 S - 8 mm	10

Order No.	page
24941	10
24942	10
24943	10
24944	10
24945	10
24946	18
24947	18
24948	18
24949	18
24950	18
24951	11
24952	11
24953	11
24954	11
24955	11
24956	18
24957	18
24958	18
24959	18
24960	18
24961	11
24962	11
24963	11
24964	11
24965	11
24966	18
24967	18
24968	18
24969	18
24970	18
24971	11
24972	11
24973	11
24974	11
24975	11
24976	18
24977	18
24978	18
24979	18
24980	31
24982	10
24983	10
24984	10
24991	37
24992	37
24993	37
24994	37
24995	37
24996	37
24997	37
24998	37
24999	37
25000	37
25001	37
25002	37
25007	31
25008	31
25009	31
25010	31
25011	31
25012	31

Order No.	page
25015	14
25016	14
25017	13
25018	14
25679	27
25711	41
25712	41
25713	41
25714	41
25715	41
25730	52
25731	41
25766	28
25768	29
25771	52
25772	52
25773	52
25774	52
25775	52
25776	52
25777	52
25790	33, 44
25827	29
25834	29
25835	29
25843	27
25844	29
25852	49
25853	49
25854	49
25855	49
25856	49
25857	49
25858	49
25859	49
25860	49
25861	49
25862	50
25863	50
25864	50
25865	50
25866	51
25884	49
25885	49
26265	40
26266	40
26267	40
26268	40
26269	40
26270	40
26271	40
26273	40

Alphabetical order

	Order No.	page
20° ProHeal Cap Long Ø 5.5 - 5.8 mm	24159	24
20° ProHeal Cap Short Ø 4.3 - 4 mm	24162	24
20° ProHeal Cap Short Ø 5.5 - 3.8 mm	24158	24
20° UniAbutment 3.5/4.0 - 0.5 mm	24893	22
20° UniAbutment 3.5/4.0 - 1 mm	24894	22
20° UniAbutment 3.5/4.0 - 2 mm	24895	22
20° UniAbutment 3.5/4.0 - 4 mm	24896	22
20° UniAbutment 3.5/4.0 - 6 mm	24897	22
20° UniAbutment 3.5/4.0 - 8 mm	24898	22
20° UniAbutment 4.5/5.0 - 0.5 mm	24398	22
20° UniAbutment 4.5/5.0 - 1 mm	24399	22
20° UniAbutment 4.5/5.0 - 2 mm	24400	22
20° UniAbutment 4.5/5.0 - 4 mm	24401	22
20° UniAbutment 4.5/5.0 - 6 mm	24402	22
20° UniAbutment 4.5/5.0 - 8 mm	24403	22
20° UniAbutment Pick-up Ø 4.3	22882	24
20° UniAbutment Pick-up Ø 5.5	22876	24
20°/45° UniAbutment Transfer	22068	24
45° ProHeal Cap Long Ø 5.5 - 5.8 mm	24161	23
45° ProHeal Cap Short Ø 4.3 - 2.7 mm	24163	23
45° ProHeal Cap Short Ø 5.5 - 3.8 mm	24160	23
45° UniAbutment 3.5/4.0 - 0.5 mm	24899	22
45° UniAbutment 3.5/4.0 - 1 mm	24900	22
45° UniAbutment 3.5/4.0 - 2 mm	24901	22
45° UniAbutment 3.5/4.0 - 4 mm	24902	22
45° UniAbutment 3.5/4.0 - 6 mm	24903	22
45° UniAbutment 3.5/4.0 - 8 mm	24904	22
45° UniAbutment 4.5/5.0 - 0.5 mm	24406	22
45° UniAbutment 4.5/5.0 - 1 mm	24407	22
45° UniAbutment 4.5/5.0 - 2 mm	24408	22
45° UniAbutment 4.5/5.0 - 4 mm	24409	22
45° UniAbutment 4.5/5.0 - 6 mm	24410	22
45° UniAbutment 4.5/5.0 - 8 mm	24411	22
45° UniAbutment Pick-up Ø 4.3	22883	24
45° UniAbutment Pick-up Ø 5.5	22878	24
Abutment Adapter - Long	24370	52
Abutment Adapter - Short	24424	52
Abutment Depth Gauge	24573	45
Abutment Guide Pin - 13 mm	22190	24
Abutment Guide Pin - 16 mm	22197	24
Abutment Guide Pin - 19 mm	22198	24
Abutment Guide Pin - 22 mm	22199	24
Abutment Replica Angled	24227	24
Abutment Replica Uni 20°	22069	24
Abutment Replica Uni 45°	22070	24
Abutment Retriever	22429	51
Abutment Screw 3.0 - M1.4	24189	14, 16
Abutment Screw Angled 4.5/5.0 - M2	22487	23
Abutment Screw Angled 3.5/4.0 - M1.6	24439	23
Abutment Screw Design 3.5/4.0 - M1.6	24449	14, 16, 17
Abutment Screw Design 4.5/5.0 - M2	24209	14, 16, 17
Angled Abutment 3.5/4.0 - 0.8 mm	24245	23
Angled Abutment 3.5/4.0 - 2 mm	24246	23
Angled Abutment 3.5/4.0 NI - 0.8 mm	24347	23
Angled Abutment 3.5/4.0 NI - 2 mm	24348	23
Angled Abutment 4.5/5.0 - 0.5 mm	24247	23
Angled Abutment 4.5/5.0 - 2 mm	24248	23
Angled Abutment 4.5/5.0 NI - 0.5 mm	24606	23
Angled Abutment 4.5/5.0 NI - 2 mm	24607	23
Angled Abutment Pick-up	24254	24
Ball Abutment 3.5/4.0 - 1 mm	24905	28
Ball Abutment 3.5/4.0 - 2 mm	24906	28
Ball Abutment 3.5/4.0 - 4 mm	24907	28
Ball Abutment 3.5/4.0 - 6 mm	24908	28
Ball Abutment 3.5/4.0 - 8 mm	24909	28
Ball Abutment 4.5/5.0 - 0.5 mm	24418	28
Ball Abutment 4.5/5.0 - 1 mm	24419	28
Ball Abutment 4.5/5.0 - 2 mm	24420	28
Ball Abutment 4.5/5.0 - 4 mm	24421	28
Ball Abutment 4.5/5.0 - 6 mm	24422	28
Ball Abutment 4.5/5.0 - 8 mm	24423	28

	Order No.	page
Ball Abutment Pick-up	22439	29
Ball Abutment Replica	22505	29
Ball Driver EV	25768	29
Ball Wrench	24367	29
BoneTrap™	22179	41
Bridge Screw Hex	22435	25
Bridge Screw Slot	22167	25
Burnout Cylinder Angled	22448	25
Burnout Cylinder Uni 20°	22186	25
Burnout Cylinder Uni 45°	22187	25
Carrier Extension - Long	24135	45
Carrier Extension - Short	24134	45
CastDesign™ 3.5/4.0	22843	17
CastDesign™ 4.5/5.0	22844	17
Conical Drill Ø 2.7/4.5 (light blue) Short	24924	39
Conical Drill Ø 2.7/4.5 (light blue) Long	24925	39
Conical Drill Ø 3.2/5.0 (no color) Short	24926	39
Conical Drill Ø 3.2/5.0 (no color) Long	24927	39
Conical Drill Ø 4.5 (green) Long	22895	39
Conical Drill Ø 4.5 (green) Short	22894	39
Conical Drill Ø 5.0 (black) Long	22897	39
Conical Drill Ø 5.0 (black) Short	22896	39
Contra Angle W&H WI-75 E/KM	26273	40
Contra Angle W&H WS-75	26268	40
Contra Angle W&H WS-75 L G	26269	40
Cortical Drill Ø 2.7/3.0 (light blue) Short	24800	39
Cortical Drill Ø 3.2/3.5 (green) Short	22815	39
Cortical Drill Ø 3.7/4.0 (black) Short	22816	39
Cortical Drill Ø 4.7/5.0 (blue) Short	22469	39
Cover Screw 3.0 - 0 mm	24198	12
Cover Screw 3.5/4.0 - 0 mm	24328	12
Cover Screw 3.5/4.0 - 1 mm	24329	12
Cover Screw 4.5/5.0 - 0 mm	24447	12
Cover Screw 4.5/5.0 - 1 mm	24448	12
DA 4 Metal Carrier	22850	20
Dalbo Plus Duplicating Aid	25827	29
Dalbo Plus Female Part TE Basic, complete	25834	29
Dalbo Plus Screwdriver/Activator	25835	29
Direct Abutment 3.5/4.0 - Ø 4, 0.5 mm	24910	20
Direct Abutment™ 3.5/4.0 - Ø 4, 1 mm	24911	20
Direct Abutment™ 3.5/4.0 - Ø 4, 2.5 mm	24912	20
Direct Abutment™ 3.5/4.0 - Ø 4, 4 mm	24913	20
Direct Abutment™ 3.5/4.0 - Ø 5, 1 mm	24914	20
Direct Abutment™ 3.5/4.0 - Ø 5, 2.5 mm	24915	20
Direct Abutment™ 3.5/4.0 - Ø 5, 4 mm	24916	20
Direct Abutment™ 4.5/5.0 - Ø 5, 0.5 mm	24527	20
Direct Abutment™ 4.5/5.0 - Ø 5, 1 mm	24528	20
Direct Abutment™ 4.5/5.0 - Ø 5, 2.5 mm	24529	20
Direct Abutment™ 4.5/5.0 - Ø 5, 4 mm	24530	20
Direct Abutment™ 4.5/5.0 - Ø 6, 1 mm	24537	20
Direct Abutment™ 4.5/5.0 - Ø 6, 2.5 mm	24538	20
Direct Abutment™ 4.5/5.0 - Ø 6, 4 mm	24539	20
Direct Abutment API™ 3.5/4.0 - Ø 4, 0.5 mm	24917	19
Direct Abutment API™ 3.5/4.0 - Ø 4, 1 mm	24918	19
Direct Abutment API™ 3.5/4.0 - Ø 4, 2.5 mm	24919	19
Direct Abutment API™ 3.5/4.0 - Ø 4, 4 mm	24920	19
Direct Abutment API™ 3.5/4.0 - Ø 5, 1 mm	24921	19
Direct Abutment API™ 3.5/4.0 - Ø 5, 2.5 mm	24922	19
Direct Abutment API™ 3.5/4.0 - Ø 5, 4 mm	24923	19
Direct Abutment API™ 4.5/5.0 - Ø 5, 0.5 mm	24558	19
Direct Abutment API™ 4.5/5.0 - Ø 5, 1 mm	24559	19
Direct Abutment API™ 4.5/5.0 - Ø 5, 2.5 mm	24560	19
Direct Abutment API™ 4.5/5.0 - Ø 5, 4 mm	24561	19
Direct Abutment API™ 4.5/5.0 - Ø 6, 1 mm	24562	19
Direct Abutment API™ 4.5/5.0 - Ø 6, 2.5 mm	24563	19
Direct Abutment API™ 4.5/5.0 - Ø 6, 4 mm	24564	19
Direct Abutment™ Burnout Cylinder Ø 4	22372	20
Direct Abutment™ Burnout Cylinder Ø 5	22373	20
Direct Abutment™ Burnout Cylinder Ø 6	22379	20
Direct Abutment™ Carrier Ø 4	24137	20
Direct Abutment™ Carrier Ø 5	24138	20

	Order No.	page
Direct Abutment™ Carrier Ø 6	24139	20
Direct Abutment™ Healing Cap Ø 4	22720	20
Direct Abutment™ Healing Cap Ø 5	22721	20
Direct Abutment™ Healing Cap Ø 6	22722	20
Direct Abutment™ Impression Pick-up Ø 4	22710	20
Direct Abutment™ Impression Pick-up Ø 5	22711	20
Direct Abutment™ Impression Pick-up Ø 6	22712	20
Direct Abutment™ Replica Ø 4	22054	20
Direct Abutment™ Replica Ø 5	22064	20
Direct Abutment™ Replica Ø 6	22065	20
Direction Indicator 2.0/3.2	22434	32
Drill Extension	22520	39
Driver Handle	24358	32
Foot Control S-N2, with cord	26267	40
Forceps - 94 mm	22437	33
Fragment Drill Ø 0.8	25858	49
Fragment Drill Ø 1.0	25859	49
Fragment Fork, Ø 0.8	25856	49
Fragment Fork, Ø 1.0	25857	49
Fragment Fork, Thin, Ø 0.8	22122	49
Fragment Fork, Wide, Ø 1.0	22632	49
Grinding Device Cylinder, Bridge Hole	22820	46
Grinding Device Uni 20°	22170	46
Grinding Handle	22740	46
Guide Drill Ø 1.8	22800	38
Guiding Cylinder TX 3.0	25852	49
Guiding Cylinder TX 3.5, 4.0	25853	49
Guiding Cylinder TX 4.5, 5.0	25854	49
Guiding Cylinder UniAbutment 20°	25884	49
Guiding Cylinder UniAbutment 45°	25885	49
Guiding Cylinder Handle	25855	49
Handpiece Connector Carrier	24133	45
Handpiece W&H S-11 Straight	26270	40
Handpiece W&H S-9 Angled	26271	40
Healing Abutment 3.0 - Ø 4, 2 mm	24777	13
Healing Abutment 3.0 - Ø 4, 4 mm	24778	13
Healing Abutment 3.0 - Ø 4, 6 mm	25017	13
Healing Abutment 3.5/4.0 - Ø 4, 2 mm	24574	13
Healing Abutment 3.5/4.0 - Ø 4.5, 4 mm	24575	13
Healing Abutment 3.5/4.0 - Ø 4.5, 6 mm	24576	13
Healing Abutment 3.5/4.0 - Ø 5.5, 2 mm	24577	13
Healing Abutment 3.5/4.0 - Ø 5.5, 4 mm	24578	13
Healing Abutment 3.5/4.0 - Ø 5.5, 6 mm	24579	13
Healing Abutment 3.5/4.0 - Ø 6.5, 4 mm	24580	13
Healing Abutment 3.5/4.0 - Ø 6.5, 6 mm	24581	13
Healing Abutment 4.5/5.0 - Ø 5.5, 2 mm	24582	13
Healing Abutment 4.5/5.0 - Ø 5.5, 4 mm	24583	13
Healing Abutment 4.5/5.0 - Ø 5.5, 6 mm	24584	13
Healing Abutment 4.5/5.0 - Ø 6.5, 2 mm	24585	13
Healing Abutment 4.5/5.0 - Ø 6.5, 4 mm	24586	13
Healing Abutment 4.5/5.0 - Ø 6.5, 6 mm	24587	13
Healing Abutment Uni 3.5/.4.0 - 10 mm	24378	12
Healing Abutment Uni 3.5/.4.0 - 2 mm	24374	12
Healing Abutment Uni 3.5/.4.0 - 4 mm	24375	12
Healing Abutment Uni 3.5/.4.0 - 6 mm	24376	12
Healing Abutment Uni 3.5/.4.0 - 8 mm	24377	12
Healing Abutment Uni 4.5/.5.0 - 10 mm	24383	12
Healing Abutment Uni 4.5/.5.0 - 2 mm	24379	12
Healing Abutment Uni 4.5/.5.0 - 4 mm	24380	12
Healing Abutment Uni 4.5/.5.0 - 6 mm	24381	12
Healing Abutment Uni 4.5/.5.0 - 8 mm	24382	12
Healing Cap, Angled Ø 5 - 7.5 mm	24092	23
Hex CA Driver - Long	22549	33, 44
Hex CA Driver - Short, 22 mm	25790	33, 44
Hex CA Driver - Short, 24 mm	22548	33, 44
Hex Driver EV Manual - Intermediate, 31 mm	25772	52
Hex Driver EV Manual - Long, 38 mm	25773	52
Hex Driver EV Manual - Short, 20 mm	25771	52
Hex Screwdriver - Intermediate	22515	33, 44, 52
Hex Screwdriver - Long	22516	33, 44, 52
Hex Screwdriver - Short	22514	33, 44, 52
Implant 900 Set SI-915, 120 V	26265	40
Implant Depth Gauge, 6-19 mm	24801	32

	Order No.	page
Implant Driver 3.0 - Long	25008	31
Implant Driver 3.0 - Short	25007	31
Implant Driver 3.5/4.0 - Long	25010	31
Implant Driver 3.5/4.0 - Short	25009	31
Implant Driver 4.5/5.0 - Long	25012	31
Implant Driver 4.5/5.0 - Short	25011	31
Implant Guide Pin 3.0 - Long	24976	18
Implant Guide Pin 3.0 - Short	24970	18
Implant Guide Pin 3.5/4.0 - Long	24969	18
Implant Guide Pin 3.5/4.0 - Short	24968	18
Implant Guide Pin 4.5/5.0 - Long	24967	18
Implant Guide Pin 4.5/5.0 - Short	24966	18
Implant Pick-up 3.0 - Long	24949	18
Implant Pick-up 3.0 - Short	24950	18
Implant Pick-up 3.5/4.0 - Long	24948	18
Implant Pick-up 3.5/4.0 - Short	24947	18
Implant Pick-up 3.5/4.0 NI - Long	24937	18
Implant Pick-up 3.5/4.0 NI - Short	24936	18
Implant Pick-up 4.5/5.0 - Long	24946	18
Implant Pick-up 4.5/5.0 NI - Long	24929	18
Implant Pick-up 4.5/5.0 - Short	24938	18
Implant Pick-up 4.5/5.0 NI - Short	24928	18
Implant Replica 3.0	24977	18
Implant Replica 3.5/4.0	24978	18
Implant Replica 4.5/5.0	24979	8
Implant Retriever	22192	51
Implant Transfer 3.0 - Long	24958	18
Implant Transfer 3.5/4.0 - Long	24960	18
Implant Transfer 3.5/4.0 - Short	24959	18
Implant Transfer 4.5/5.0 - Long	24957	18
Implant Transfer 4.5/5.0 - Short	24956	18
Irrigation Set	24785	50
Lab Abutment Screw, Angled	24860	46
Lab Abutment Screw 3.0	24802	46
Lab Abutment Screw Design 3.5/4.0	24857	46
Lab Abutment Screw Design 4.5/5.0	24858	46
Lab bridge screw, hex and slot	24859	46
Lamellae retention Insert E	25844	29
Locator™ Abutment 3.5/4.0 - Ø 3.7, 1 mm	24268	27
Locator™ Abutment 3.5/4.0 - Ø 3.7, 2 mm	24269	27
Locator™ Abutment 3.5/4.0 - Ø 3.7, 3 mm	24270	27
Locator™ Abutment 3.5/4.0 - Ø 3.7, 4 mm	24271	27
Locator™ Abutment 3.5/4.0 - Ø 3.7, 5 mm	24272	27
Locator™ Abutment 4.5/5.0 - Ø 4.0, 0.5 mm	24477	27
Locator™ Abutment 4.5/5.0 - Ø 4.0, 2 mm	24478	27
Locator™ Abutment 4.5/5.0 - Ø 4.0, 3 mm	24479	27
Locator™ Abutment 4.5/5.0 - Ø 4.0, 4 mm	24480	27
Locator™ Abutment 4.5/5.0 - Ø 4.0, 5 mm	24481	27
Locator™ Abutment Pick-up	24484	27
Locator™ Abutment Replica	24485	27
Locator™ Core Tool	24482	28
Locator™ Driver EV	25766	28
Locator™ Insert Male Blue	24488	27
Locator™ Insert Male Clear	24486	27
Locator™ Insert Male Pink	24487	27
Locator™ Insert Extended Range Male Green	24489	27
Locator™ Insert Extended Range Male Grey	25679	27
Locator™ Insert Extended Range Male Orange	25843	27
Locator™ Insert Extended Range Male Red	24492	27
Locator™ Process Kit	24483	27
Locator Torque Wrench Bit - 15 mm	24490	28
Locator Torque Wrench Bit - 21 mm	24491	28
Motor EM-19	26266	40
Mucosal Punch Ø 3.5	25711	41
Mucosal Punch Ø 4.0	25712	41
Mucosal Punch Ø 4.5	25713	41
Mucosal Punch Ø 5.0	25714	41
Mucosal Punch Ø 5.5	25715	41
Mucosal Punch Ø 6.5	25731	41
OD Cylinder Uni 20°	22182	29
OD Cylinder Uni 45°	22183	29
O-ring, Abutment Adapter, Plastic	22376	52
O-ring, Carrier Extension	22416	43, 45

	Order No.	page		Order No.	page
OsseoSpeed® TX 3.0 S - 11 mm	24982	10	Restorative Tray	22495	43
OsseoSpeed® TX 3.0 S - 13 mm	24983	10	Screw Extractor Ø 0.8	25860	49
OsseoSpeed® TX 3.0 S - 15 mm	24984	10	Screw Extractor Ø 1.0	25861	49
OsseoSpeed® TX 3.5 S - 8 mm	24930	10	Semi-Burnout Cylinder Angled	24243	25
OsseoSpeed® TX 3.5 S - 9 mm	24931	10	Semi-Burnout Cylinder Uni 20°	22184	25
OsseoSpeed® TX 3.5 S - 11 mm	24932	10	Semi-Burnout Cylinder Uni 45°	22185	25
OsseoSpeed® TX 3.5 S - 13 mm	24933	10	Slot CA Driver - Long	22689	45
OsseoSpeed® TX 3.5 S - 15 mm	24934	10	Slot CA Driver - Short	22688	45
OsseoSpeed® TX 3.5 S - 17 mm	24935	10	Slot Screwdriver - Intermediate	22507	45
OsseoSpeed® TX 4.0 S - 6 mm	24939	10	Slot Screwdriver - Long	22508	45
OsseoSpeed® TX 4.0 S - 8 mm	24940	10	Slot Screwdriver - Short	22506	45
OsseoSpeed® TX 4.0 S - 9 mm	24941	10	SP Conical Drill Ø 2.7/4.5 mm Long	25000	37
OsseoSpeed® TX 4.0 S - 11 mm	24942	10	SP Conical Drill Ø 2.7/4.5 mm Short	24999	37
OsseoSpeed® TX 4.0 S - 13 mm	24943	10	SP Conical Drill Ø 3.2/4.5 mm Short	22921	37
OsseoSpeed® TX 4.0 S - 15 mm	24944	10	SP Conical Drill Ø 3.2/5.0 mm Long	25002	37
OsseoSpeed® TX 4.0 S - 17 mm	24945	10	SP Conical Drill Ø 3.2/5.0 mm Short	25001	37
OsseoSpeed® TX 4.5 - 9 mm	24951	11	SP Conical Drill Ø 3.7/5.0 mm Short	22923	37
OsseoSpeed® TX 4.5 - 11 mm	24952	11	SP Conical Drill Ø 4.5 mm Long	22922	37
OsseoSpeed® TX 4.5 - 13 mm	24953	11	SP Conical Drill Ø 5.0 mm Long	22924	37
OsseoSpeed® TX 4.5 - 15 mm	24954	11	SP Cortical Drill Ø 2.7/3.0 mm Short	24998	37
OsseoSpeed® TX 4.5 - 17 mm	24955	11	SP Cortical Drill Ø 3.2/3.5 mm Short	22914	37
OsseoSpeed® TX 5.0 - 9 mm	24961	11	SP Cortical Drill Ø 3.5 mm Long	22915	37
OsseoSpeed® TX 5.0 - 11 mm	24962	11	SP Cortical Drill Ø 3.7/4.0 mm Short	22916	37
OsseoSpeed® TX 5.0 - 13 mm	24963	11	SP Cortical Drill Ø 4.0 mm Long	22917	37
OsseoSpeed® TX 5.0 - 15 mm	24964	11	SP Cortical Drill Ø 4.7/5.0 mm Short	22964	37
OsseoSpeed® TX 5.0 - 17 mm	24965	11	SP Drill Kit 6-13 mm	24737	36
OsseoSpeed® TX 5.0 S - 9 mm	24971	11	SP Drill Kit, Long	22899	36
OsseoSpeed® TX 5.0 S - 11 mm	24972	11	SP Drill Kit, Short	22898	36
OsseoSpeed® TX 5.0 S - 13 mm	24973	11	SP Pilot Drill Ø 2.0/3.2, 6-13 mm	24735	37
OsseoSpeed® TX 5.0 S - 15 mm	24974	11	SP Pilot Drill Ø 2.0/3.2 mm Long	22905	37
OsseoSpeed® TX 5.0 S - 17 mm	24975	11	SP Pilot Drill Ø 2.0/3.2 mm Short	22904	37
Osteotome 2.0/2.5, Concave, Bayonet	22940	34	SP Pilot Drill Ø 2.0/2.7 mm Short	24997	37
Osteotome 2.0/2.5, Round, Straight	22930	34	SP Pilot Drill Ø 3.2/3.7 mm Long	22907	37
Osteotome 2.5/3.2, Concave, Bayonet	22941	34	SP Pilot Drill Ø 3.2/3.7 mm Short	22906	37
Osteotome 2.5/3.2, Round, Straight	22931	34	SP Pilot Drill Ø 3.7/4.2 mm Short	22963	37
Osteotome 3.2, Concave, Bayonet	22942	34	SP Twist Drill Ø 2.0 mm Long	24991	37
Osteotome 3.2, Round, Straight	22932	34	SP Twist Drill Ø 2.0 mm Short	24992	37
Osteotome 3.2/3.7, Concave, Bayonet	22943	34	SP Twist Drill Ø 2.7 mm Long	24993	37
Osteotome 3.2/3.7, Round, Straight	22933	34	SP Twist Drill Ø 2.7 mm Short	24994	37
Osteotome 3.2/4.3, Concave, Conical, Bayonet	22945	34	SP Twist Drill Ø 2.85 mm Long	24995	37
Osteotome 3.2/4.3, Round, Conical, Straight	22935	34	SP Twist Drill Ø 2.85 mm Short	24996	37
Osteotome 3.7, Concave, Bayonet	22944	34	SP Twist Drill Ø 3.35 mm Long	22909	37
Osteotome 3.7, Round, Straight	22934	34	SP Twist Drill Ø 3.35 mm Short	22908	37
Osteotome 3.7/4.2, Concave, Bayonet	24688	35	SP Twist Drill Ø 3.7, 6-13 mm	24199	37
Osteotome 3.7/4.2, Round, Straight	24339	35	SP Twist Drill Ø 3.7 mm Long	22911	37
Osteotome 3.7/4.8, Concave, Conical, Bayonet	22946	34	SP Twist Drill Ø 3.7 mm Short	22910	37
Osteotome 3.7/4.8, Round, Conical, Straight	22936	34	SP Twist Drill Ø 3.85 mm, 6-13 mm	24734	37
Osteotome 4.2, Concave, Bayonet	24689	35	SP Twist Drill Ø 3.85 mm Long	22913	37
Osteotome 4.2, Round, Straight	24684	35	SP Twist Drill Ø 3.85 mm Short	22912	37
Osteotome 4.2/4.7, Concave, Bayonet	24690	35	SP Twist Drill Ø 4.2 mm Long	22958	37
Osteotome 4.2/4.7, Round, Straight	24685	35	SP Twist Drill Ø 4.2 mm Short	22957	37
Osteotome 4.7, Concave, Bayonet	24691	35	SP Twist Drill Ø 4.7 mm Long	22960	37
Osteotome 4.7, Round, Straight	24686	35	SP Twist Drill Ø 4.7 mm Short	22959	37
Osteotome Kit	22956	34	SP Twist Drill Ø 4.85 mm Long	22962	37
Osteotome Mallet, Small	22955	34	SP Twist Drill Ø 4.85 mm Short	22961	37
Osteotome Set 5.0 S, Concave	24692	35	Surgical Instrument Kit	24980	31
Osteotome Set 5.0 S, Round	24687	35	Surgical Tray	24349	31
Osteotome Set, Concave	22947	34	TempDesign™ 3.5/4.0	22851	14
Osteotome Set, Round	22937	34	TempDesign™ 4.5/5.0	22852	14
Osteotome Tray, Large	22953	35	TempDesign™ 3.5/4.0 NI	22853	14
Osteotome Tray, Small	24693	35	TempDesign™ 4.5/5.0 NI	22854	14
Pilot Drill Ø 2.0/2.7 mm (light blue)	24795	39	Temporary Abutment 3.0	25018	14
Pilot Drill Ø 2.0/3.2 mm (green)	24207	39	Temporary Abutment 3.5/4.0	24281	14
Pilot Drill Ø 2.5/3.2 mm (green)	22803	39	Temporary Abutment 3.5/4.0 NI	24280	14
Pilot Drill Ø 3.2/3.7 mm (black)	22805	39	Temporary Abutment 4.5/5.0	25015	14
Pilot Drill Ø 3.7/4.2, Yellow	22468	39	Temporary Abutment 4.5/5.0 NI	25016	14
Polishing Protector Uni 20°	22471	46	Temporary Abutment Angled	22447	25
Polishing Protector Uni 45°	22474	46	Temporary Cylinder Uni 20°	22060	25
Radiographic Implant Guides	24892	11	Temporary Cylinder Uni 45°	22061	25
Ratchet Wrench	24357	32	Thread Cleaner M1.4	25862	50
Removal Tool M1.4 - Short	24021	51	Thread Cleaner M1.6	25863	50
Removal Tool M1.4 - Long	24037	51	Thread Cleaner M1.8	25864	50
Restorative Instrument Kit	24879	43	Thread Cleaner M2.0	25865	50

	Order No.	page
Thread Tap, 1.4 mm	22871	50
Thread Tap, 1.6 mm	22873	50
Thread Tap, 2.0 mm	22875	50
TiDesign™ 3.0 - Ø 4.0, 1 mm	24788	16
TiDesign™ 3.0 - Ø 4.0, 2 mm	24789	16
TiDesign™ 3.0 - Ø 4.0, 15° mm	24790	16
TiDesign™ 3.5/4.0 - Ø 4.5, 1.5 mm	24285	17
TiDesign™ 3.5/4.0 - Ø 4.5, 20°	24291	17
TiDesign™ 3.5/4.0 - Ø 4.5, 3 mm	24286	17
TiDesign™ 3.5/4.0 - Ø 5.5, 1.5 mm	24287	17
TiDesign™ 3.5/4.0 - Ø 5.5, 20°	24292	17
TiDesign™ 3.5/4.0 - Ø 5.5, 3 mm	24288	17
TiDesign™ 3.5/4.0 - Ø 6.5, 1.5 mm	24289	17
TiDesign™ 3.5/4.0 - Ø 6.5, 3 mm	24290	17
TiDesign™ 4.5/5.0 - Ø 5.5, 1.5 mm	24235	17
TiDesign™ 4.5/5.0 - Ø 5.5, 20°	24239	17
TiDesign™ 4.5/5.0 - Ø 5.5, 3 mm	24236	17
TiDesign™ 4.5/5.0 - Ø 6.5, 1.5 mm	24237	17
TiDesign™ 4.5/5.0 - Ø 6.5, 3 mm	24238	17
Titanium Bowl	22137	32
Titanium Cylinder Angled	24244	25
Titanium Cylinder Uni 20°	22798	25
Titanium Cylinder Uni 45°	22799	25
Torque Wrench	24075	44
Torque Wrench Bit Hex, Short	24093	43
Torque Wrench Bit Hex, Long	24094	43
Torque Wrench Bit Slot, Short	24095	43
Torque Wrench Bit Slot, Long	24096	43
Torque Wrench Connector, Adapter	24097	43
Torque Wrench EV	25774	52
Torque Wrench EV,		
Restorative Driver Handle, 11.5 mm	25777	52
Torque Wrench EV,		
Restorative Driver Handle, 15.5 mm	25776	52
Torque Wrench EV,		
Restorative Driver Handle, 4x4 Low	25730	52
Torque Wrench EV,		
Surgical Driver Handle, 15.3 mm	25775	52
Torque Wrench Instrument Lubricant	24098	43
Torque Wrench Dismantle Tool	24099	43
Torque Wrench Kit	24100	43
Trephine Drill, Ø 3.0	25866	51
Trephine Drill, Ø 3.5	22884	51

	Order No.	page
Trephine Drill, Ø 4.0	22885	51
Trephine Drill, Ø 5.0	22890	51
Tubing Cover Sleeve	24787	50
Tubing Extension with Luer	24786	50
Twist Drill Ø 2.0, 8-13 mm (no color) Short	22887	38
Twist Drill Ø 2.5, 8-13 mm (red) Short	22802	38
Twist Drill Ø 2.7, 8-19 mm (light blue) Long	24796	38
Twist Drill Ø 2.7, 8-13 mm (light blue) Short	24797	38
Twist Drill Ø 2.85, 8-19 mm (silver) Long	24798	38
Twist Drill Ø 2.85, 8-13 mm (silver) Short	24799	38
Twist Drill Ø 3.2, 8-13 mm (green) Short	22811	38
Twist Drill Ø 3.35, 8-13 mm (lilac) Short	22812	38
Twist Drill Ø 3.7, 8-13 mm (black) Short	22813	38
Twist Drill Ø 3.85, 8-13 mm (brown) Short	22814	38
Twist Drill Ø 4.2, 8-13 mm (yellow) Short	22463	38
Twist Drill Ø 4.2, 8-19 mm (yellow) Long	22462	38
Twist Drill Ø 4.7, 8-19 mm (blue) Long	22464	38
Twist Drill Ø 4.7, 8-13 mm (blue) Short	22465	38
Twist Drill Ø 4.85, 8-19 mm (pink) Long	22466	38
Twist Drill Ø 4.85, 8-13 mm (pink) Short	22467	38
Twist Drill Ø 2.0, 8-19 mm (no color) Long	22886	38
Twist Drill Ø 2.5, 8-19 mm (red) Long	22801	38
Twist Drill Ø 3.2, 8-19 mm (green) Long	22807	38
Twist Drill Ø 3.35, 8-19 mm (lilac) Long	22808	38
Twist Drill Ø 3.7, 8-19 mm (black) Long	22809	38
Twist Drill Ø 3.85, 8-19 mm (brown) Long	22810	38
Wrench	22124	33, 52
Wrench Adapter	24572	32
ZirDesign™ 3.5/4.0 - Ø 4.4, 1.5 mm	24702	16
ZirDesign™ 3.5/4.0 - Ø 4.5, 3 mm	24703	16
ZirDesign™ 3.5/4.0 - Ø 5.5, 1.5 mm	24704	16
ZirDesign™ 3.5/4.0 - Ø 5.5, 3 mm	24705	16
ZirDesign™ 3.5/4.0 - Ø 5.5, 3.5 mm, 20°	24706	16
ZirDesign™ 4.5/5.0 - Ø 5.5, 1.5 mm	24707	16
ZirDesign™ 4.5/5.0 - Ø 5.5, 3 mm	24708	16
ZirDesign™ 4.5/5.0 - Ø 6.5, 1.5 mm	24709	16
ZirDesign™ 4.5/5.0 - Ø 6.5, 3 mm	24710	16
ZirDesign™ 4.5/5.0 - Ø 5.5, 3.5 mm, 20°	24711	16

Return Policy

We gladly accept products for return that meet the requirements below. To initiate a return, you must fill out a **Return Goods Form**.

- Returns must be initiated within 90 days of purchase (invoice date).
- Items must be in their original undamaged, unmarked and unopened packaging with factory seals intact.
- Customized products, hazmat, equipment, and other certain products are not eligible for return. Please contact us for further details.
- All return shipping charges will be paid by Dentsply Sirona. After a Return Goods Form is approved, Dentsply Sirona will provide a shipping label to use. Method of shipping will be ground.
- Purchase price will be used for valuation of return amount.

Human tissue products

All terms and conditions applicable, with the following exception:

- No exchanges or return credit will be provided for human tissue products having less than an 18 month shelf life remaining.

Contact our Customer Service Department at 800-531-3481 if you have any questions.

About Dentsply Sirona Implants

Dentsply Sirona Implants offers comprehensive solutions for all phases of implant therapy, including Ankylos®, Astra Tech Implant System® and Xive® implant lines, digital technologies, such as Atlantis® patient-specific solutions and Simplant® guided surgery, Symbios® regenerative solutions, and professional and business development programs, such as STEPPS™. Dentsply Sirona Implants creates value for dental professionals and allows for predictable and lasting implant treatment outcomes, resulting in enhanced quality of life for patients.

About Dentsply Sirona

Dentsply Sirona is the world's largest manufacturer of professional dental products and technologies, with a 130-year history of innovation and service to the dental industry and patients worldwide. Dentsply Sirona develops, manufactures, and markets a comprehensive solutions offering including dental and oral health products as well as other consumable medical devices under a strong portfolio of world class brands. As The Dental Solutions Company™, Dentsply Sirona's products provide innovative, high-quality and effective solutions to advance patient care and deliver better, safer and faster dentistry. Dentsply Sirona's global headquarters is located in York, Pennsylvania, and the international headquarters is based in Salzburg, Austria. The company's shares are listed in the United States on NASDAQ under the symbol XRAY.

Visit www.dentsplysirona.com for more information about Dentsply Sirona and its products.