

SureSmile® Patient Kit Wear and Care Guide

 SureSmile®
Clear Aligners

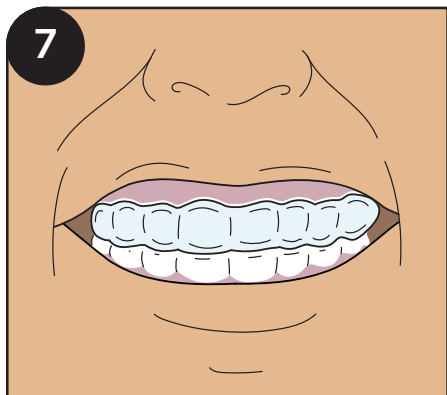
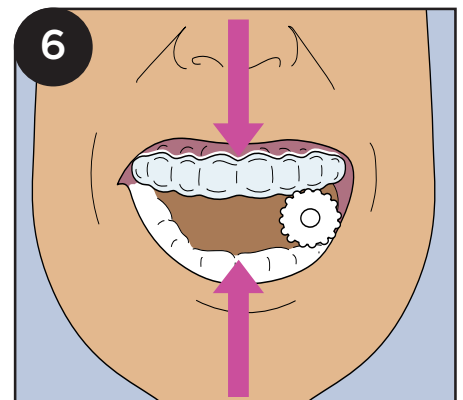
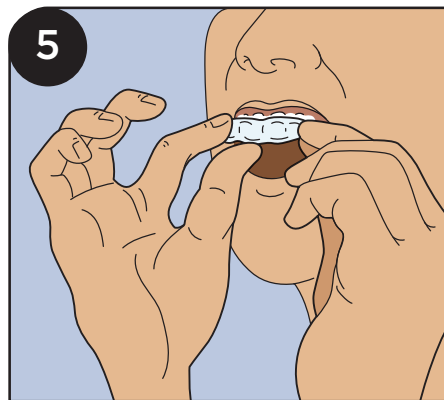
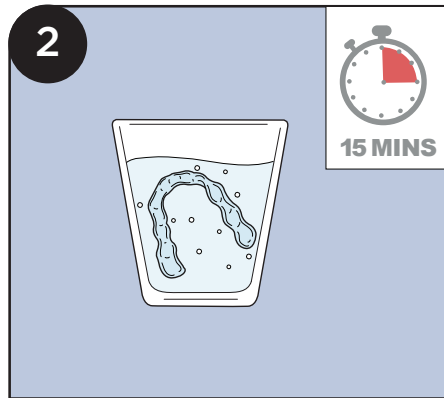
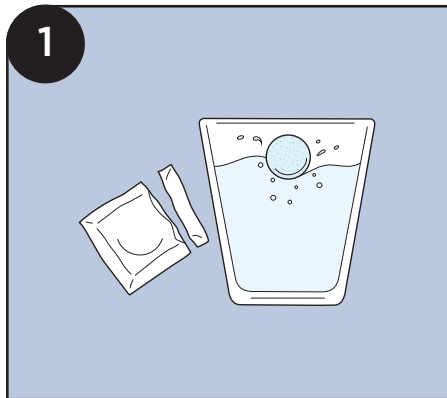
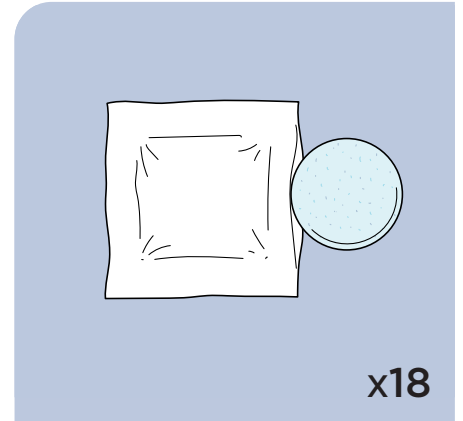
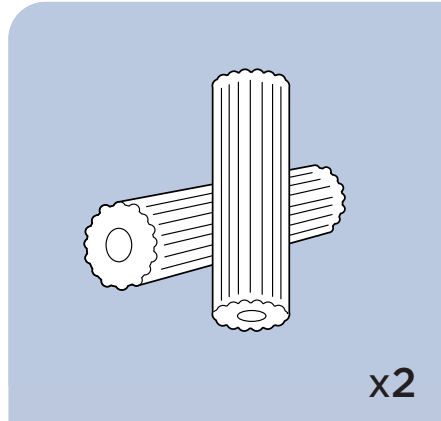
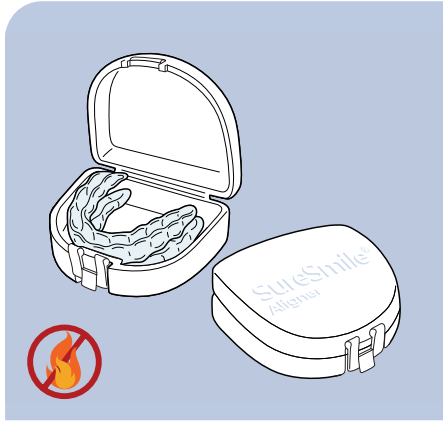

SureSmile® Patient Kit Wear and Care Guide

 SureSmile®
Clear Aligners

