



DS Implants

EV Prosthetics product catalogue

DS PrimeTaper™

Astra Tech Implant System® EV

All Dentsply Sirona Instructions for Use are available on www.dentsplysirona.com/ifu

All products may not be regulatory cleared/released/licensed in all markets. Please contact the local Dentsply Sirona sales office for current product assortment and availability.

To improve readability for our customers, Dentsply Sirona does not use ® or ™ in body copy. However, Dentsply Sirona does not waive any right to the trademark and nothing herein shall be interpreted to the contrary.

Product illustrations are not to scale.

CONTENTS

1. Introduction	4
Colour coding	4
Implant-abutment connection	5
Prosthetic packaging	5
2. Overviews	6
3. Cover screw	16
4. Healing abutments	
HealDesign	16
Healing Abutment	18
5. Temporary abutments	
Temp Abutment	19
Abutment screws	19
6. Impression and laboratory components	
Implant Pick-Up Design	20
Implant Transfer	21
Digital impression components	22
Implant Analogue	23
Lab Abutment screws	23
7. Cement-retained restorations	
TiDesign	24
CastDesign	26
TitaniumBase	27
8. Screw-retained restorations	
MultiBase	28
9. Attachment-retained restorations	
LOCATOR R-Tx®	34
10. Restorative Instruments	38
Prosthetic Tray	40
11. Appendix	41
12. Material specifications	42
13. Index	43

1. Introduction

Throughout the prosthetic assortment, markings, colour coding and geometrical designs simplify the correct identification of corresponding components.

Each implant-abutment connection size is identified by a specific colour. The colour is applied directly to components and instruments, as well as on packaging and informational material, where appropriate.

DS PrimeTaper – has the same implant-abutment connection as Astra Tech Implant System EV.

Colour coding

PrimeTaper EV	Ø3.0 mm*	Ø3.6 mm	Ø4.2 mm	Ø4.8 mm	Ø5.4 mm
Connections		S	M	L	L
Astra Tech Implant EV	Ø3.0 mm	Ø3.6 mm	Ø4.2 mm	Ø4.8 mm	Ø5.4 mm
Ø mm	3.0	3.6	4.2	4.8	5.4
	↕	↕	↕	↕	↕
Connections	XS	S	M	L	XL

* Not yet available for PrimeTaper EV.

Implant-abutment connection

The implants have a unique interface providing three different options for abutment placement/indexing.

Abutment placement/indexing options

One-position-only

Atlantis patient-specific abutments will only seat in one position.

Six positions

Indexed abutments will seat in six available positions.

Non-indexed

Non-indexed abutments will be seated in any rotational position.

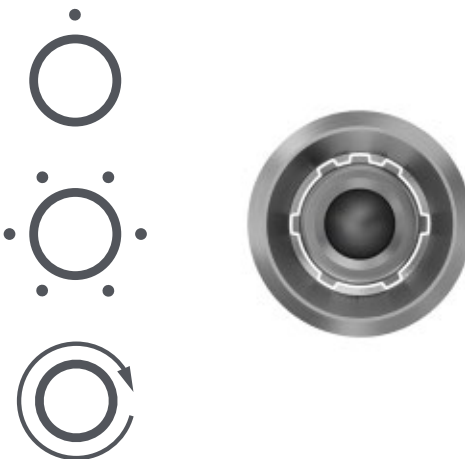

Prosthetic packaging



XS Overview

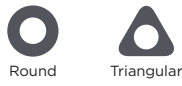

Cover screw

Cover Screw EV



68010001

Healing abutments

HealDesign EV



- ∅ 3.5 2.5 mm 68013001
- ∅ 3.5 3.5 mm 68013002
- ∅ 3.5 4.5 mm 68013003
- ∅ 3.5 6.5 mm 68013004

Healing Abutment EV



- ∅ 4.0 2.0 mm 68013044
- ∅ 4.0 3.0 mm 68013045
- ∅ 4.0 4.0 mm 68013046
- ∅ 4.0 6.0 mm 68013047

Cement-retained

Temporary abutments and components

TempAbutment EV*



∅ 3.3 1 mm 68013064

Abutments

TiDesign EV



- ∅ 4.0 1.5 mm 68012001
- ∅ 4.0 2.5 mm 68012002
- ∅ 4.0 3.5 mm 68012003
- ∅ 4.0 4.5 mm 68012004
- ∅ 4.0 15° 1.5 mm 68012005
- ∅ 4.0 15° 2.5 mm 68012006
- ∅ 4.0 15° 3.5 mm 68012007
- ∅ 4.0 15° 4.5 mm 68012008

TitaniumBase EV*



∅ 4.0 1 mm 68012081
∅ 4.0 2 mm 68012082

* Also for screw-retained single tooth restoration

Screw-retained

Abutments

MultiBase Abutment EV



- 1.5 mm 68012171
- 2.5 mm 68012172
- 3.5 mm 68012173

Healing caps

MultiBase Heal Cap



∅ 5.4 - 4 mm
68012230

Impressions

MultiBase Pick-Up



68012232

MultiBase Transfer



68012231

XS is not yet available for PrimeTaper EV

Implant impressions

Implant Pick-Up EV Design



Long 68014013

Implant Transfer EV



Long 68014022

Lab products

Lab Abutment Screw EV



68014029

Implant Analogue EV



68014034

Lab products

MultiBase Lab Bridge Screw



68012237

MultiBase Analogue



68012238

MultiBase Lab Abutment Pin



14 mm 68012234
18 mm 68012235
22 mm 68012236

Cylinders

MultiBase Temporary Cylinder



68012239

MultiBase Burnout Cylinder



68012240

MultiBase Semi-Burnout Cylinder



68012243

Bridge screws

MultiBase Bridge Screw



68012233

XS is not yet available for PrimeTaper EV

S Overview



One-position-only Six positions Non-indexed



Round Triangular

Cover screw

Cover Screw EV



68010002

Healing abutments

HealDesign EV



- Ø 4.0 2.5 mm 68013005
- Ø 4.0 3.5 mm 68013006
- Ø 4.0 4.5 mm 68013007
- Ø 4.0 6.5 mm 68013008
- Ø 5.0 2.5 mm 68013009
- Ø 5.0 3.5 mm 68013010
- Ø 5.0 4.5 mm 68013011
- Ø 5.0 6.5 mm 68013012
- Ø 6.0 3.5 mm 68013013
- Ø 6.0 4.5 mm 68013014
- Δ Ø 5.0 3.5 mm 68013039

Healing Abutment EV



- Ø 4.0 2.0 mm 68013048
- Ø 4.0 3.0 mm 68013049
- Ø 4.0 4.0 mm 68013050
- Ø 4.0 6.0 mm 68013051

Cement-retained

Temporary abutments and components

TempAbutment EV*



Ø 4.0 1 mm 68013066

Abutments

TiDesign EV



- Ø 4.5 1.5 mm 68012009
- Ø 4.5 2.5 mm 68012010
- Ø 4.5 3.5 mm 68012011
- Ø 4.5 4.5 mm 68012012
- Ø 4.5 15° 1.5 mm 68012017
- Ø 4.5 15° 2.5 mm 68012018
- Ø 4.5 15° 3.5 mm 68012019
- Ø 4.5 15° 4.5 mm 68012020
- △ Ø 5.5 1.5 mm 68012025

CastDesign EV*



Ø 4.1 1 mm 68012077

TitaniumBase EV*



Ø 4.1 1 mm 68012083
Ø 4.1 2 mm 68012084

* Also for screw-retained single tooth restoration

Screw-retained

Abutments

MultiBase Abutment EV



- 1.5 mm 68012174
- 2.5 mm 68012175
- 3.5 mm 68012176
- 4.5 mm 68012177
- 30° 1.5 mm 68012186
- 30° 2.5 mm 68012187
- 30° 1.5 mm 68012190
- 30° 2.5 mm 68012191
- 17° 1.5 mm 68012178
- 17° 2.5 mm 68012179
- 17° 3.5 mm 68012180
- 17° 4.5 mm 68012181
- 17° 1.5 mm 68012182
- 17° 2.5 mm 68012183
- 17° 3.5 mm 68012184
- 17° 4.5 mm 68012185

Healing caps

MultiBase Heal Cap



Ø 5.4 - 4 mm
68012230

Attachment-retained

Abutments

LOCATOR R-Tx® Abutment EV



- 1 mm 68012414
- 2 mm 68012415
- 3 mm 68012416
- 4 mm 68012417
- 5 mm 68012418
- 6 mm 68012419

Abutment impressions

LOCATOR R-Tx® Impression Coping



68012444

Analogue

LOCATOR R-Tx® Abutment Analogue



68012443

Implant impressions

Implant Pick-Up EV Design



Short 68014009
Long 68014014

Implant Transfer EV



Short 68014018
Long 68014023

Lab products

Lab Abutment Screw EV



68014030

Implant Analogue EV



68014035

Impressions

MultiBase Pick-Up



68012232

MultiBase Transfer



68012231

Lab products

MultiBase Lab Bridge Screw



68012237

MultiBase Analogue



68012238

MultiBase Lab Abutment Pin



14 mm 68012234
18 mm 68012235
22 mm 68012236

Cylinders

MultiBase Temporary Cylinder



68012239

MultiBase Burnout Cylinder



68012240

MultiBase Semi-Burnout Cylinder



68012243

Bridge screws

MultiBase Bridge Screw



68012233

Attachment components

LOCATOR R-Tx® Mixed Retention Limited Range Processing Pack



68012439

LOCATOR R-Tx® Retention Insert Standard range



Grey 68012432
Blue 68012433
Pink 68012434
Clear 68012435

LOCATOR R-Tx® Retention Insert Limited range



Aqua 68012436
Magenta 68012437
Gold 68012438

LOCATOR R-Tx® Processing Insert



68012440

LOCATOR R-Tx® Block-Out Spacer



68012441

LOCATOR R-Tx® Denture Attachment Processing Assembly



68012442

LOCATOR R-Tx® Processing Spacer



68012445

M Overview

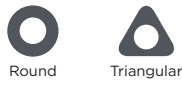

Cover screw

Cover Screw EV



68010005

Healing abutments

HealDesign EV



	● Ø 5.0 2.5 mm 68013015
	● Ø 5.0 3.5 mm 68013016
	● Ø 5.0 4.5 mm 68013017
	● Ø 5.0 6.5 mm 68013018
	● Ø 6.5 2.5 mm 68013019
	● Ø 6.5 3.5 mm 68013020
	● Ø 6.5 4.5 mm 68013021
	● Ø 6.5 6.5 mm 68013022
	▲ Ø 5.0 3.5 mm 68013040
	▲ Ø 6.5 3.5 mm 68013041

Healing Abutment EV



	● Ø 4.0 2.0 mm 68013052
	● Ø 4.0 3.0 mm 68013053
	● Ø 4.0 4.0 mm 68013054
	● Ø 4.0 6.0 mm 68013055

Cement-retained

Temporary abutments and components

TempAbutment EV*



Ø 4.5 1 mm 68013070

Abutments

TiDesign EV



● Ø 5.5	1.5 mm	68012042
● Ø 5.5	2.5 mm	68012043
● Ø 5.5	3.5 mm	68012044
● Ø 5.5	4.5 mm	68012045
● Ø 5.5 15°	1.5 mm	68012046
● Ø 5.5 15°	2.5 mm	68012047
● Ø 5.5 15°	3.5 mm	68012048
● Ø 5.5 15°	4.5 mm	68012049
▲ Ø 5.5	1.5 mm	68012050
▲ Ø 7.0	1.5 mm	68012051

CastDesign EV*



Ø 4.1 1 mm 68012078

TitaniumBase EV*



Ø 4.7 1 mm 68012088
Ø 4.7 2 mm 68012089

* Also for screw-retained single tooth restoration

Screw-retained

Abutments

MultiBase Abutment EV



	1.5 mm 68012194		30° 1.5 mm 68012206
	2.5 mm 68012195		30° 2.5 mm 68012207
	3.5 mm 68012196		30° 1.5 mm 68012208
	4.5 mm 68012197		30° 2.5 mm 68012209
	17° 1.5 mm 68012198		
	17° 2.5 mm 68012199		
	17° 3.5 mm 68012200		
	17° 4.5 mm 68012201		
	17° 1.5 mm 68012202		
	17° 2.5 mm 68012203		
	17° 3.5 mm 68012204		
	17° 4.5 mm 68012205		

Healing caps

MultiBase Heal Cap



Ø 5.4 - 4 mm
68012230

Attachment-retained

Abutments

LOCATOR R-Tx® Abutment EV



1 mm	68012420
2 mm	68012421
3 mm	68012422
4 mm	68012423
5 mm	68012424
6 mm	68012425

Abutment impressions

LOCATOR R-Tx®
Impression Coping



68012444

Analogue

LOCATOR R-Tx®
Abutment Analogue



68012443

Implant impressions

Implant Pick-Up EV Design



Short 68014010
Long 68014015

Implant Transfer EV



Short 68014019
Long 68014024

Lab products

Lab Abutment Screw EV



68014031

Implant Analogue EV



68014036

Impressions

MultiBase Pick-Up



68012232

MultiBase Transfer



68012231

Lab products

MultiBase Lab Bridge Screw



68012237

MultiBase Analogue



68012238

MultiBase Lab Abutment Pin



14 mm 68012234
18 mm 68012235
22 mm 68012236

Cylinders

MultiBase Temporary Cylinder



68012239

MultiBase Burnout Cylinder



68012240

MultiBase Semi-Burnout Cylinder



68012243

Bridge screws

MultiBase Bridge Screw



68012233

Attachment components

LOCATOR R-Tx® Mixed Retention Limited Range Processing Pack



68012439

LOCATOR R-Tx® Retention Insert Standard range



Grey 68012432
Blue 68012433
Pink 68012434
Clear 68012435

LOCATOR R-Tx® Retention Insert Limited range



Aqua 68012436
Magenta 68012437
Gold 68012438

LOCATOR R-Tx® Processing Insert



68012440

LOCATOR R-Tx® Block-Out Spacer



68012441

LOCATOR R-Tx® Denture Attachment Processing Assembly



68012442

LOCATOR R-Tx® Processing Spacer



68012445

L Overview

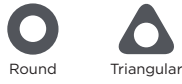

Cover screw

Cover Screw EV



68010006

Healing abutments

HealDesign EV



	●	Ø 5.0	2.5 mm	68013023
	●	Ø 5.0	3.5 mm	68013024
	●	Ø 5.0	4.5 mm	68013025
	●	Ø 5.0	6.5 mm	68013026
	●	Ø 6.5	2.5 mm	68013027
	●	Ø 6.5	3.5 mm	68013028
	●	Ø 6.5	4.5 mm	68013029
	●	Ø 6.5	6.5 mm	68013030
	●	Ø 7.5	3.5 mm	68013031
	●	Ø 7.5	4.5 mm	68013032
	▲	Ø 5.0	3.5 mm	68013042
	▲	Ø 6.5	3.5 mm	68013043

Healing Abutment EV



	●	Ø 4.3	2.0 mm	68013056
	●	Ø 4.3	3.0 mm	68013057
	●	Ø 4.3	4.0 mm	68013058
	●	Ø 4.3	6.0 mm	68013059

Cement-retained

Temporary abutments and components

TempAbutment EV*



Abutments

TiDesign EV



●	Ø 7.0	1.5 mm	68012052
●	Ø 7.0	2.5 mm	68012053
●	Ø 7.0	3.5 mm	68012054
●	Ø 7.0	4.5 mm	68012055
●	Ø 5.5 15°	1.5 mm	68012056
●	Ø 5.5 15°	2.5 mm	68012057
●	Ø 5.5 15°	3.5 mm	68012058
●	Ø 5.5 15°	4.5 mm	68012059
▲	Ø 5.5	1.5 mm	68012060
▲	Ø 7.0	1.5 mm	68012061

CastDesign EV*



Ø 5.1 1 mm 68012079

TitaniumBase EV*



Ø 5.0 1 mm 68012090
Ø 5.0 2 mm 68012091

* Also for screw-retained single tooth restoration

Screw-retained

Abutments

MultiBase Abutment EV



	●	1.5 mm	68012210		30°	1.5 mm	68012221
	●	2.5 mm	68012211		30°	2.5 mm	68012222
	●	3.5 mm	68012212		30°	1.5 mm	68012223
	●	4.5 mm	68012213		30°	2.5 mm	68012224
	●	17°	1.5 mm	68012214			
	●	17°	2.5 mm	68012215			
	●	17°	3.5 mm	68012216			
	●	17°	4.5 mm	68012217			
	●	17°	1.5 mm	68012218			
	●	17°	2.5 mm	68012219			
	●	17°	3.5 mm	68012220			
	●	17°	4.5 mm	68012232			

Healing caps

MultiBase Heal Cap



Ø 5.4 - 4 mm
68012230

Attachment-retained

Abutments

LOCATOR R-Tx® Abutment EV



●	1 mm	68012426
●	2 mm	68012427
●	3 mm	68012428
●	4 mm	68012429
●	5 mm	68012430
●	6 mm	68012431

Abutment impressions

LOCATOR R-Tx® Impression Coping



68012444

Analogue

LOCATOR R-Tx® Abutment Analogue



68012443

Implant impressions

Implant Pick-Up EV Design



Short 68014011
Long 68014016

Implant Transfer EV



Short 68014020
Long 68014025

Lab products

Lab Abutment Screw EV



68014032

Implant Analogue EV



68014037

Impressions

MultiBase Pick-Up



68012232

MultiBase Transfer



68012231

Lab products

MultiBase Lab Bridge Screw



68012237

MultiBase Analogue



68012238

MultiBase Lab Abutment Pin



14 mm 68012234
18 mm 68012235
22 mm 68012236

Cylinders

MultiBase Temporary Cylinder



68012239

MultiBase Burnout Cylinder



68012240

MultiBase Semi-Burnout Cylinder



68012243

Bridge screws

MultiBase Bridge Screw



68012233

Attachment components

LOCATOR R-Tx® Mixed Retention Limited Range Processing Pack



68012439

LOCATOR R-Tx® Retention Insert Standard range



Grey 68012432
Blue 68012433
Pink 68012434
Clear 68012435

LOCATOR R-Tx® Retention Insert Limited range



Aqua 68012436
Magenta 68012437
Gold 68012438

LOCATOR R-Tx® Processing Insert



68012440

LOCATOR R-Tx® Block-Out Spacer



68012441

LOCATOR R-Tx® Denture Attachment Processing Assembly



68012442

LOCATOR R-Tx® Processing Spacer



68012445

XL Overview

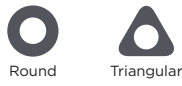

Cover screw

Cover Screw EV



68010007

Healing abutments

HealDesign EV



- Ø 6.5 2.5 mm 68013033
- Ø 6.5 3.5 mm 68013034
- Ø 6.5 4.5 mm 68013035
- Ø 6.5 6.5 mm 68013036
- Ø 7.5 3.5 mm 68013037
- Ø 7.5 4.5 mm 68013038

Healing Abutment EV



- Ø 4.8 2.0 mm 68013060
- Ø 4.8 3.0 mm 68013061
- Ø 4.8 4.0 mm 68013062
- Ø 4.8 6.0 mm 68013063

Cement-retained

Temporary abutments and components

TempAbutment EV*



Ø 5.5 1 mm 68013074

Abutments

TiDesign EV



- Ø 7.0 1.5 mm 68012062
- Ø 7.0 2.5 mm 68012063
- Ø 7.0 15° 1.5 mm 68012064
- Ø 7.0 15° 2.5 mm 68012065

CastDesign EV*



Ø 5.1 1 mm 68012080

TitaniumBase EV*



Ø 4.0 1 mm 68012081
Ø 4.0 2 mm 68012082

* Also for screw-retained single tooth restoration

Screw-retained

Abutments

MultiBase Abutment EV



- 1.5 mm 68012225
- 2.5 mm 68012226
- 3.5 mm 68012227
- 4.5 mm 68012228

Healing caps

MultiBase Heal Cap



Ø 5.4 - 4 mm
68012230

Impressions

MultiBase Pick-Up



68012232

MultiBase Transfer



68012231

XL is not applicable for PrimeTaper EV

Implant impressions

Implant Pick-Up EV Design



Short 68014012
Long 68014017

Implant Transfer EV



Short 68014021
Long 68014026

Lab products

Lab Abutment Screw EV



68014033

Implant Analogue EV



68014038

Lab products

MultiBase Lab Bridge Screw



68012237

MultiBase Analogue



68012238

MultiBase Lab Abutment Pin



14 mm 68012234
18 mm 68012235
22 mm 68012236

Cylinders

MultiBase Temporary Cylinder



68012239

MultiBase Burnout Cylinder



68012240

MultiBase Semi-Burnout Cylinder



68012243

Bridge screws

MultiBase Bridge Screw



68012233

XL is not applicable for PrimeTaper EV

3. Cover screw

Cover Screw EV

Titanium alloy¹, sterile

The Cover Screw is used for sealing the implant interface.

- Clinical use: two-stage surgical procedures
- Colour coded

Cover Screw EV



	XS *	S	M	L	XL **
Order No.	68010001	68010002	68010005	68010006	68010007

4. Healing abutments

HealDesign EV

Titanium alloy¹, sterile

The HealDesign is used for soft tissue sculpturing during the healing phase.

- The design of the healing abutments is based upon the natural dentition utilising a site-specific, crown-down approach.
- The design mimic a variety of tooth shapes and support the soft tissue preparing for the final abutment.
- Heights and diameters are harmonised with the final abutments and with the expected tooth positions.
- Clinical use: one- and two-stage surgery
- Colour coded
- Indexing options; six-position and non-indexed

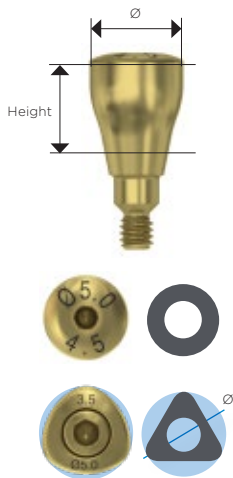

Round shapes are indicated for all positions in the mouth.

Triangular shapes are designed for anterior implant sites and mimic the specific shape for incisors and canines. Triangular HealDesign EV is a two-piece abutment.

XS HealDesign EV*

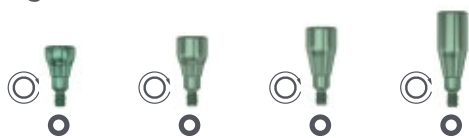

∅ mm	3.5	3.5	3.5	3.5
Height mm	2.5	3.5	4.5	6.5
Order No.	68013001	68013002	68013003	68013004

S HealDesign EV



∅ mm	4	4	4	4
Height mm	2.5	3.5	4.5	6.5
Order No.	68013005	68013006	68013007	68013008



∅ mm	5	5	5	5
Height mm	2.5	3.5	4.5	6.5
Order No.	68013009	68013010	68013011	68013012



∅ mm	6	6	5
Height mm	3.5	4.5	3.5
Order No.	68013013	68013014	68013039

*Not yet available for PrimeTaper EV

**Not applicable for PrimeTaper EV

M HealDesign EV



Ø mm	5	5	5	5
Height mm	2.5	3.5	4.5	6.5
Order No.	68013015	68013016	68013017	68013018

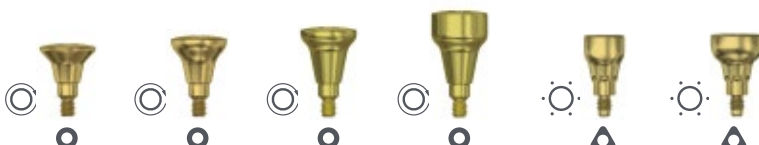

Ø mm	6.5	6.5	6.5	6.5	5	6.5
Height mm	2.5	3.5	4.5	6.5	3.5	3.5
Order No.	68013019	68013020	68013021	68013022	68013040	68013041

L HealDesign EV



Ø mm	5	5	5	5
Height mm	2.5	3.5	4.5	6.5
Order No.	68013023	68013024	68013025	68013026



Ø mm	6.5	6.5	6.5	6.5	7.5	7.5	5	6.5
Height mm	2.5	3.5	4.5	6.5	3.5	4.5	3.5	3.5
Order No.	68013027	68013028	68013029	68013030	68013031	68013032	68013042	68013043

XL HealDesign EV**



Ø mm	6.5	6.5	6.5	6.5	7.5	7.5
Height mm	2.5	3.5	4.5	6.5	3.5	4.5
Order No.	68013033	68013034	68013035	68013036	68013037	68013038

**Not applicable for PrimeTaper EV

Healing Abutment EV

Titanium alloy¹, sterile

The healing abutment is used for soft tissue sculpturing.

- Height markings
- Colour-coded
- Indexing option; non-indexed

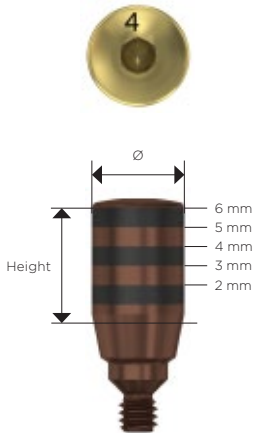

XS Healing Abutment EV*



Ø mm	4	4	4	4
Height mm	2	3	4	6
Order No.	68013044	68013045	68013046	68013047

S Healing Abutment EV



Ø mm	4	4	4	4
Height mm	2	3	4	6
Order No.	68013048	68013049	68013050	68013051

M Healing Abutment EV



Ø mm	4	4	4	4
Height mm	2	3	4	6
Order No.	68013052	68013053	68013054	68013055

L Healing Abutment EV



Ø mm	4.3	4.3	4.3	4.3
Height mm	2	3	4	6
Order No.	68013056	68013057	68013058	68013059

XL Healing Abutment EV**



Ø mm	4.8	4.8	4.8	4.8
Height mm	2	3	4	6
Order No.	68013060	68013061	68013062	68013063

*Not yet available for PrimeTaper EV

**Not applicable for PrimeTaper EV

5. Temporary abutments

TempAbutment EV



Ø mm	3.3	4.0	4.5	5.0	5.5
A - height mm	1	1	1	1	1
B - height mm	9	9	9	9	9
Order No.	68013064	68013066	68013070	68013072	68013074

TempAbutment EV

Titanium alloy¹, non-sterile

The temporary abutment is used as a customisable base for temporary implant-level restorations and allows for further sculpturing of the soft tissue.

- Designed for build-up technique
- Primarily processed in the laboratory
- Restoration: screw- and cement-retained
- Clinical use: long-term temporisation
- Contains: TempAbutment EV and corresponding colour-coded Abutment Screw EV
- Screw-retained restorations, limited to single tooth only
- Indexing option; six-positions

Patient specific products - alternative restorative options



Atlantis Healing Abutment



Atlantis CustomBase Solution - Atlantis Abutment and Atlantis Temporary Crown

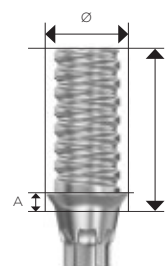

Abutment Screw EV

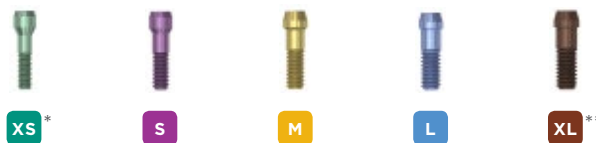

	M1.4	M1.6	M1.8	M2.0	M2.0
Order No.	68012166	68012167	68012168	68012169	68012170

Abutment Screw EV

Titanium alloy¹, non-sterile

The abutment screw is used for securing the abutment to the implant.

- A corresponding abutment screw is included with every two-piece abutment.
- Additional screws can be ordered separately
- Colour coded

¹Not yet available for PrimeTaper EV

^{**}Not applicable for PrimeTaper EV

6. Impression and laboratory components

Implant Pick-Up EV Design

Titanium alloy¹, non-sterile

The implant pick-up is used for transferring the implant position and the soft tissue anatomy to the master model.

- Self-guiding impression component
- Indexing options; one-position-only, six positions and non-indexed
- Integrated pin for safe handling
- Designed with a hex at the pin head
- One-hand-procedure
- Designed for splinting possibilities
- Clinical use: open tray impression procedure
- Colour coded
- Contains: Implant Pick-Up EV Design with pin
- Instruments needed: Hex Driver (optional)

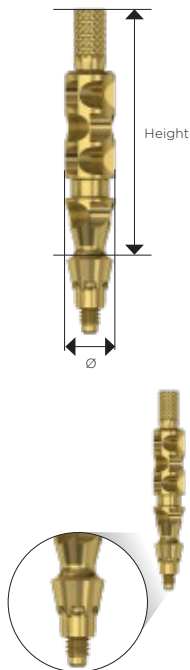

Implant Pick-Up EV Design, Short

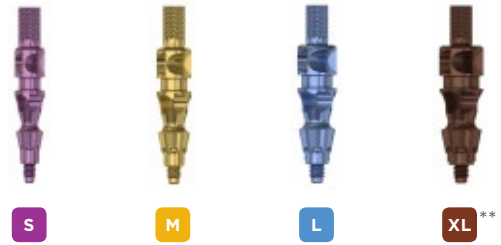

∅ mm		3.6	4.2	4.8	5.4
Height mm		16.7	16.7	16.7	16.7
Order No.		68014009	68014010	68014011	68014012

Implant Pick-Up EV Design, Long

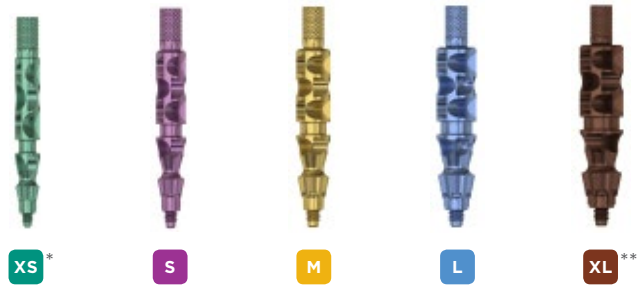

∅ mm	3.0	3.6	4.2	4.8	5.4
Height mm	22	22	22	22	22
Order No.	68014013	68014014	68014015	68014016	68014017

*Not yet available for PrimeTaper EV

**Not applicable for PrimeTaper EV

Implant Transfer EV, Short



Ø mm		3.6	4.2	4.8	5.4
Height mm		11	11	11	11
Order No.		68014018	68014019	68014020	68014021

Implant Transfer EV

Titanium alloy³, non-sterile

The implant transfer is used for transferring the implant position and the soft tissue anatomy to the master model.

- Self-guiding impression component
- Indexing options; one-position-only, six positions and non-indexed
- Integrated pin for safe handling
- One-hand procedure
- Designed with a hex at the pin head
- Clinical use: closed tray impression procedure
- Colour coded
- Contains: Implant Transfer EV with pin
- Instruments needed: Hex Driver (optional)

Implant Transfer EV, Long

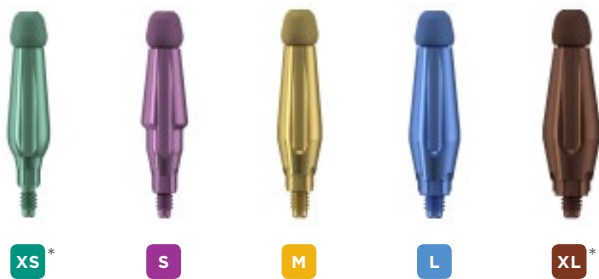

Ø mm	3.5	3.6	4.2	4.8	5.4
Height mm	14	14	14	14	14
Order No.	68014022	68014023	68014024	68014025	68014026

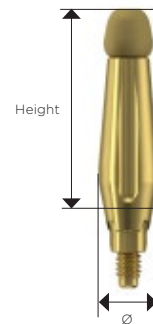

*Not yet available for PrimeTaper EV

**Not applicable for PrimeTaper EV

Digital impression components

Atlantis IO FLO, Atlantis FLO

Atlantis IO FLO is a scan body used for implant level digital impressions.

Atlantis FLO is a scan body used for implant level model scanning.

- Can be used with all connectivity when scanning for Atlantis abutments.
- Enables the design software to create a sufficient output to produce the restoration onto the TitaniumBase
- Instruments needed: Hex Driver for Atlantis IO FLO and Atlantis FLO screwdriver for Atlantis FLO.

A digital library is required when designing restorations for TitaniumBase. The digital library includes all necessary information of the implant system, TitaniumBase and scanbody. The libraries can be used for 3Shape and Exocad design software.

To download The TitaniumBase library, go to the help page for Dentsply Sirona Implants libraries at <https://www.orderdigitalsolutions.com/>

Atlantis IO FLO



	XS*	S	M	L	XL**
IO FLO code	IO P-01	IO P-02	IO P-03	IO P-04	IO P-05
Order No.	35243	35244	35245	35246	35247

Atlantis FLO



	XS*	S	M	L	XL**
FLO code	P-01	P-02	P-03	P-04	P-05
Order No.	34593	34594	34595	34596	34597

Atlantis IO FLO-S

Atlantis IO FLO-S is a scan body used for implant or abutment level digital impressions.

- Atlantis IO FLO-S is used when scanning for Atlantis suprastructure.
- Can be used for both intraoral and model scanning.

The FLO-S scan body without the IO marking can only be used for model scanning and is not approved for intraoral scanning.

Atlantis IO FLO-S



	XS*	S	M	L	XL**
FLO code	A04K	A04L	A04M	A04N	A04O
Order No.	68020018	68020019	68020020	68020021	68020022

*Not yet available for PrimeTaper EV

**Not applicable for PrimeTaper EV

Implant Analogue EV



Height mm	16.5	16.5	16.5	16.5	16.5
Order No.	68014034	68014035	68014036	68014037	68014038

Implant Analogue EV

Titanium alloy¹, non-sterile

The implant Analogue is used for laboratory fabrication of implant-level restorations.

- Single use
- Colour coded

Lab Abutment Screw EV



Order No.	68014029	68014030	68014031	68014032	68014033
-----------	----------	----------	----------	----------	----------

Lab Abutment Screw EV

Titanium alloy¹, non-sterile

The lab abutment screw is used to secure the abutment on the implant analogue.

- Designed for use with implant analogue only
- Colour coded
- Contains:
4 pcs of Lab Abutment Screw EV

*Not yet available for PrimeTaper EV

**Not applicable for PrimeTaper EV

7. Cement-retained restorations

TiDesign EV

Titanium alloy¹, non-sterile

TiDesign is used as a base for cement-retained restorations.

- Anatomically pre-designed abutment
- Round - design for the majority of tooth shapes
- Triangular - primarily for incisors and canines with distinct triangular shape
- Angled - for offset situations both in the anterior and posterior regions, compensating for implants with a restoratively unfavorable angulation
- Restoration: cement retained
- Clinical use: single and multi unit restorations
- Marked with connection size and diameter
- Colour coded
- Contains: TiDesign EV abutment and corresponding colour-coded Abutment Screw EV.
- Indexing option; six-positions

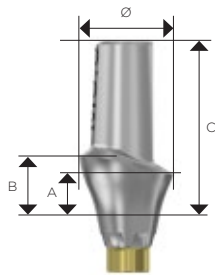

XS TiDesign EV*



Ø mm	4	4	4	4
A - height mm	1.5	2.5	3.5	4.5
B - height mm	2.5	3.5	4.5	5.5
C - height mm	7	8	9	10
Order No.	68012001	68012002	68012003	68012004



Ø mm	4	4	4	4
A - height mm	1.5	2.5	3.5	4.5
B - height mm	2.5	3.5	4.5	5.5
C - height mm	7	8	9	10
Order No.	68012005	68012006	68012007	68012008

S TiDesign EV



Ø mm	4.5	4.5	4.5	4.5
A - height mm	1.5	2.5	3.5	4.5
B - height mm	2.5	3.5	4.5	5.5
C - height mm	9	10	11	12
Order No.	68012009	68012010	68012011	68012012



Ø mm	4.5	4.5	4.5	4.5	5.5
A - height mm	1.5	2.5	3.5	4.5	1.5
B - height mm	2.5	3.5	4.5	5.5	2.5
C - height mm	9	10	11	12	9
Order No.	68012017	68012018	68012019	68012020	68012025

*Not yet available for PrimeTaper EV

M TiDesign EV



Ø mm	5.5	5.5	5.5	5.5
A - height mm	1.5	2.5	3.5	4.5
B - height mm	2.5	3.5	4.5	5.5
C - height mm	9	10	11	12
Order No.	68012042	68012043	68012044	68012045



Ø mm	5.5	5.5	5.5	5.5	5.5	7.0
A - height mm	1.5	2.5	3.5	4.5	1.5	1.5
B - height mm	2.5	3.5	4.5	5.5	2.5	2.5
C - height mm	9	10	11	12	9	9
Order No.	68012046	68012047	68012048	68012049	68012050	68012051

L TiDesign EV



Ø mm	7.0	7.0	7.0	7.0
A - height mm	1.5	2.5	3.5	4.5
B - height mm	2.5	3.5	4.5	5.5
C - height mm	9	10	11	12
Order No.	68012052	68012053	68012054	68012055



Ø mm	5.5	5.5	5.5	5.5	5.5	7.0
A - height mm	1.5	2.5	3.5	4.5	1.5	1.5
B - height mm	2.5	3.5	4.5	5.5	2.5	2.5
C - height mm	9	10	11	12	9	9
Order No.	68012056	68012057	68012058	68012059	68012060	68012061

XL TiDesign EV**



Ø mm	7.0	7.0	7.0	7.0
A - height mm	1.5	2.5	1.5	2.5
B - height mm	2.5	3.5	2.5	3.5
C - height mm	9	10	9	10
Order No.	68012062	68012063	68012064	68012065

CastDesign EV

Gold-Platinum alloy⁴ / POM plastic⁵, non-sterile

CastDesign is used for fabrication of a customised cement- or screw-retained restoration, using regular wax-up and cast-to techniques.

- Non-oxidizing high precious alloy abutment
- Modified at the laboratory
- Metal Base:
Au 60%, Pd 20%, Pt 19%, Ir 1%
- Cylinder: POM burnout plastic
- Restoration: for screw-retained restorations, CastDesign is limited to single-tooth only
- Colour coded
- Contains: CastDesign EV abutment and colour-coded Abutment Screw EV
- Indexing option; six-positions

CastDesign EV



Ø mm	4.1	4.1	5.1	5.1
A - height mm	1	1	1	1
B - height mm	11	11	11	11
Order No.	68012077	68012078	68012079	68012080

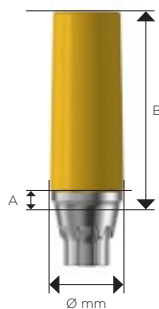

Patient specific products - alternative restorative options



Atlantis CustomBase Solution
- Atlantis Abutment and Atlantis Crown

**Not applicable for PrimeTaper EV

XS TitaniumBase EV*



Ø mm	4	4
A - height mm	1	2
B - height mm	5	6
Order No.	68012081	68012082

S TitaniumBase EV



Ø mm	4.1	4.1
A - height mm	1	2
B - height mm	5	6
Order No.	68012083	68012084

M TitaniumBase EV



Ø mm	4.7	4.7
A - height mm	1	2
B - height mm	5	6
Order No.	68012088	68012089

L TitaniumBase EV



Ø mm	5	5
A - height mm	1	2
B - height mm	5	6
Order No.	68012090	68012091

XL TitaniumBase EV**



Ø mm	5.5	5.5
A - height mm	1	2
B - height mm	5	6
Order No.	68012092	68012093

TitaniumBase EV

Titanium alloy³, non-sterile

TitaniumBase is used in the digital workflow as a base for customised ceramic restorations.

- Two flattened sides forming an anti-rotational feature
- Restoration: Cement-retained and screw-retained
- Clinical use: temporary or final restorations
- Screw-retained restorations are limited to single-tooth only
- Single and multi units
- Contains: TitaniumBase EV abutment and colour-coded Abutment Screw EV
- Instruments needed: Hex Driver and scanbody
- Indexing option; six-positions

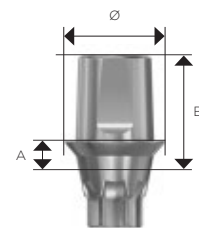

*Not yet available for PrimeTaper EV

**Not applicable for PrimeTaper EV

8. Screw-retained restorations

MultiBase Abutment EV

Titanium alloy¹ with a PEEK² holder, sterile

The MultiBase abutment is used for screw-retained restorations for multi-unit cases.

- Applicable for SmartFix concept
- Straight abutments are one-piece abutments, angled abutments are two-piece abutments
- Top cone (21°) enables bridge insertion on non-parallel abutments up to 42°
- Same prosthetic platform and components for all abutments
- Non-indexed abutments can be seated in any rotational position
- The holder on straight abutment has eight identification grooves, the holder on 17° abutment has four identification grooves, the holder on 30° abutment has six identification grooves
- Restoration: screw retained
- Clinical use: multi-unit restorations
- Colour coded
- Straight abutment contains: MultiBase Abutment EV with a plastic holder pre-mounted to the abutment
- MultiBase 17°/30° abutment contains: MultiBase Abutment EV with a separate head part and a plastic holder with a pre-assembled abutment screw
- Instruments needed: Hex Driver for installing the abutment screw. Multibase Driver for tightening the abutment head to the abutment body and for installing straight abutments
- Indexing options; non-indexed and six positions

XS MultiBase Abutment EV*



A - height mm	1.5	2.5	3.5
Order No.	68012171	68012172	68012173

S MultiBase Abutment EV



A - height mm	1.5	2.5	3.5	4.5
Order No.	68012174	68012175	68012176	68012177

S MultiBase Abutment EV 17°



A - height mm	1.5	2.5	3.5	4.5
B - height mm	3	4	5	6
Order No.	68012178	68012179	68012180	68012181
Order No.	68012182	68012183	68012184	68012185

S MultiBase Abutment EV 30°



A - height mm	1.5	2.5	1.5	2.5
B - height mm	4	5	4	5
Order No.	68012186	68012187	68012190	68012191

*Not yet available for PrimeTaper EV

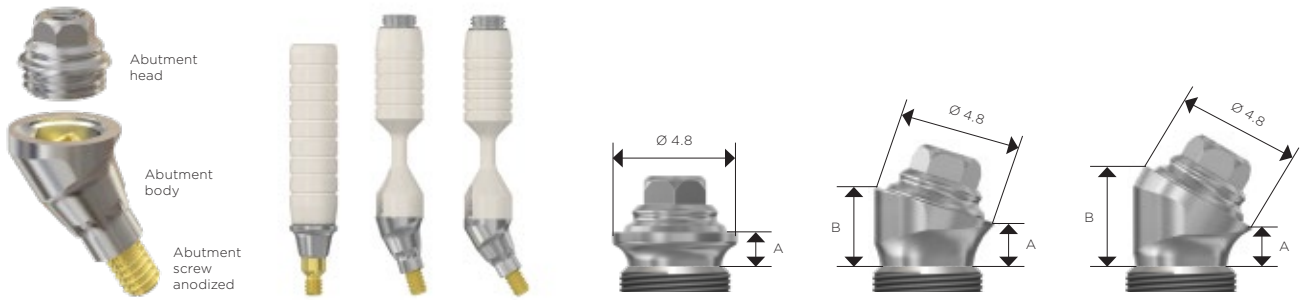

M MultiBase Abutment EV



A - height mm	1.5	2.5	3.5	4.5
Order No.	68012194	68012195	68012196	68012197

M MultiBase Abutment EV 17°



A - height mm	1.5	2.5	3.5	4.5
B - height mm	3	4	5	6
Order No.	68012198	68012199	68012200	68012201
Order No.	68012202	68012203	68012204	68012205

M MultiBase Abutment EV 30°



A - height mm	1.5	2.5	1.5	2.5
B - height mm	4	5	4	5
Order No.	68012206	68012207	68012208	68012209

L MultiBase Abutment EV



A - height mm	1.5	2.5	3.5	4.5
Order No.	68012210	68012211	68012212	68012213

L MultiBase Abutment EV 17°



A - height mm	1.5	2.5	3.5	4.5
B - height mm	3	4	5	6
Order No. ☉	68012214	68012215	68012216	68012217
Order No. ☉	68012218	68012219	68012220	68012352

L MultiBase Abutment EV 30°



A - height mm	1.5	2.5	1.5	2.5
B - height mm	4	5	4	5
Order No.	68012221	68012222	68012223	68012224

XL MultiBase Abutment EV**



A - height mm	1.5	2.5	3.5	4.5
Order No.	68012225	68012226	68012227	68012228

Patient specific products - alternative restorative options



Atlantis Bridge



Atlantis Hybrid



Atlantis BridgeBase

**Not applicable for PrimeTaper EV

MultiBase Abutment Head with holder



Order No.	68012229
-----------	----------

MultiBase Abutment Head with holder

Titanium alloy¹ with a PEEK² plastic holder, sterile

The abutment head with holder is used when needed to replace the abutment head.

- Spare part to MultiBase Abutment EV straight, Multibase Abutment EV 17° and 30°
- Single use
- Contains: MultiBase Abutment Head with holder; the head part is pre-mounted on the holder

MultiBase Heal Cap



Ø mm	5.4
Vertical height mm	4
Order No.	68012230

MultiBase Heal Cap

Titanium alloy¹, sterile

The heal cap is used to protect the abutment and for soft tissue sculpturing during the healing phase.

- One-piece
- Marked with diameter
- Single use

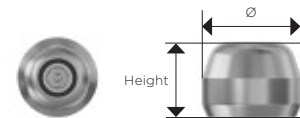

MultiBase

Pick-Up open tray technique



Transfer closed tray technique



Ø mm	5.5	5.5
Vertical height mm	15	9.5
Order No.	68012232	68012231

MultiBase Pick-Up and Transfer

Stainless steel², non-sterile

The pick-up and transfer are used for transferring the MultiBase abutment position to the master model.

- Two-piece pick-up, with a pronounced groove for splinting possibility
- Transfer two-piece
- Screw retained
- Contains: MultiBase Pick-Up and screw
- Contains: MultiBase Transfer and screw

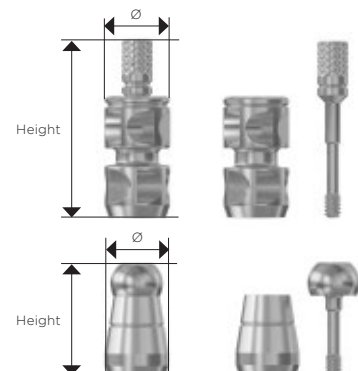

Protection sleeve

Silicone⁹, non-sterile

The protection sleeve is used to protect the soft tissue from acrylic resin.

- Single use

Protection sleeve



Order No.	68012241
-----------	----------

MultiBase Temporary Cylinder

Titanium alloy¹, non-sterile

The temporary cylinder is used for temporary restorations.

- Single use
- Restoration: screw retained
- Clinical use: multi-unit; long-term temporisation

Bridge screws need to be ordered separately.

MultiBase Temporary Cylinder



Ø mm	5.0
Vertical height mm	12
Order No.	68012239

MultiBase Burnout Cylinder

PMMA plastic¹⁰, non-sterile

The burnout cylinder is used for fabricating the final restoration.

- Single use
- Restoration: screw retained
- Clinical use: multi-unit

Bridge screws need to be ordered separately.

MultiBase Burnout Cylinder



Ø mm	4.8
Vertical height mm	10
Order No.	68012240

MultiBase Semi-Burnout Cylinder

Gold-Platinum alloy⁴ / POM plastic⁶, non-sterile

The semi-burnout cylinder is used for fabricating the final restoration.

- Single use
- Restoration: screw retained
- Clinical use: multi-unit

Bridge screws need to be ordered separately.

MultiBase Semi-Burnout Cylinder



Ø mm	5.4
Vertical height mm	14
Order No.	68012243

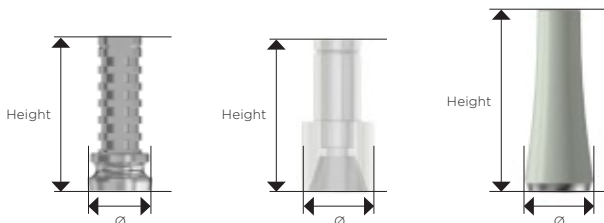

MultiBase Analogue



Order No.	68012238
-----------	----------

MultiBase Analogue

Stainless steel³, non-sterile

The analogue is used for laboratory fabrication of abutment-level restorations.

- Single use

MultiBase

Bridge Screw

Lab Bridge Screw



	M1.4	M1.4
Screw head height mm	1.65	1.65
Screw head Ø mm	2.1	2.1
Order No.	68012233	68012237

MultiBase Bridge Screw

Titanium alloy¹, non-sterile

The bridge screw is used for connecting the screw-retained restoration to the Multibase abutment.

- Light blue for differentiation to the laboratory bridge screw
- Single use
- Screw head height: 1.65 mm
- Screw head diameter: 2.1 mm
- Contains: 1 MultiBase Bridge Screw

MultiBase Lab Bridge Screw

Titanium alloy¹, non-sterile

The lab bridge screw is used for connecting the screw-retained restoration to the Multibase analog

- Screw head height: 1.65 mm
- Screw head diameter: 2.1 mm
- Contains: 4 pcs

MultiBase Lab Abutment Pin



Length mm	14	18	22
Order No.	68012234	68012235	68012236

MultiBase Lab Abutment Pin

Stainless steel³, non-sterile

The lab abutment pin is used for maintaining the screw access channel.

- Designed with a hex at the pin head

9. Attachment-retained restorations

LOCATOR R-Tx® Abutment EV

Titanium alloy¹ / TiCN Coated², non-sterile

The LOCATOR R-Tx® Abutment is used for attachment-retained restorations.

- Ability to accept up to 60 degrees of implant divergence
- Restoration: attachment retained
- Clinical use: multi-unit
- Contains: 1 abutment with complementary components (1 of each: insert Grey, Blue, Pink, Clear, Block-out spacer and Processing assembly)
- Instruments needed: Hex Driver
- Indexing option; non-indexed
- Refer to instructions for use at www.zestdent.com

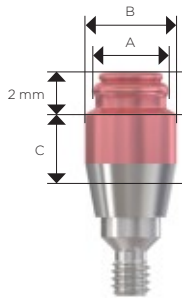

S LOCATOR R-Tx® Abutment EV

A - Ø mm	3.7	3.7	3.7	3.7	3.7	3.7
B - Ø mm	3.4	3.4	3.4	3.4	3.4	3.4
C - height mm	1	2	3	4	5	6
Order No.	68012414	68012415	68012416	68012417	68012418	68012419

M LOCATOR R-Tx® Abutment EV

A - Ø mm	3.7	3.7	3.7	3.7	3.7	3.7
B - Ø mm	3.7	3.7	3.7	3.7	3.7	3.7
C - height mm	1	2	3	4	5	6
Order No.	68012420	68012421	68012422	68012423	68012424	68012425

L LOCATOR R-Tx® Abutment EV

A - Ø mm	3.7	3.7	3.7	3.7	3.7	3.7
B - Ø mm	4.3	4.3	4.3	4.3	4.3	4.3
C - height mm	1	2	3	4	5	6
Order No.	68012426	68012427	68012428	68012429	68012430	68012431

LOCATOR R-Tx® Retention Insert Standard range



Grey



Blue



Pink



Clear

Retention	Zero	Low	Medium	High
Order No.	68012432	68012433	68012434	68012435

LOCATOR R-Tx® Retention Insert Limited range



Aqua



Magenta



Gold

Retention	Low	Medium	High
Order No.	68012436	68012437	68012438

LOCATOR R-Tx® Mixed Retention Limited Range Processing Pack



Order No.	68012439
-----------	----------

LOCATOR R-Tx® Denture Attachment Processing Assembly



Order No.	68012442
-----------	----------

LOCATOR R-Tx® Retention Insert

PA plastic¹², non-sterile

The LOCATOR R-Tx® Retention Insert is used as retention element.

- Two ranges of inserts, both types come in low, medium and high retention
- Standard range inserts can be used for any patient with implant divergence up to a total of 60 degrees
- Limited range inserts are intended for patients with 10 degrees or less of implant divergence to provide a tighter fit
- Colour-coded by retention strength
- Contains: 4 pcs of the same insert
- Instruments needed: LOCATOR R-Tx® Retention Insert Tool
- Refer to instructions for use at www.zestdent.com

LOCATOR R-Tx® Mixed Retention Limited Range Processing Pack

- Contains: 2 pcs of each insert Aqua, Magenta, Gold, Block-out spacer and Processing assembly.

LOCATOR R-Tx® Denture Attachment Processing Assembly

Titanium alloy¹ / PE plastic¹³, non-sterile

The LOCATOR R-Tx® Denture Attachment Processing Assembly is used as housing for retention insert in the restoration.

- Contains: 4 pcs (each assembly includes a housing and a pre-assembled Processing insert)
- Refer to instructions for use at www.zestdent.com

LOCATOR R-Tx® Block-Out Spacer

Silicone⁹, non-sterile

The LOCATOR R-Tx® Block-out Spacer is used to eliminate undercuts between non-parallel abutments that excess pick-up material could lock in the denture during the pick-up process.

- Contains: 20 pcs
- Refer to instructions for use at www.zestdent.com

LOCATOR R-Tx® Block-Out Spacer



Order No.	68012441
-----------	----------

LOCATOR R-Tx® Processing Insert

PE plastic¹³, non-sterile

The LOCATOR R-Tx® Processing Insert is used as a place holder for retention inserts inside the housing during the fabrication of the restoration.

- Contains: 4 pcs
- Instruments needed: LOCATOR R-Tx® Retention Insert Tool
- Refer to instructions for use at www.zestdent.com

LOCATOR R-Tx® Processing Insert



Order No.	68012440
-----------	----------

LOCATOR R-Tx® Processing Spacer

POM plastic⁶, non-sterile

The LOCATOR R-Tx® Processing Spacer is used for indirect processing of the attachment housings.

- Contains: 4 pcs
- Refer to instructions for use at www.zestdent.com

LOCATOR R-Tx® Processing Spacer



Order No.	68012445
-----------	----------

LOCATOR R-Tx® Abutment Analog Ø4

Titanium alloy¹, non-sterile

The LOCATOR R-Tx® Abutment Analog is used for laboratory fabrication of abutment-level restorations.

- Contains: 4 pcs
- Refer to instructions for use at www.zestdent.com

LOCATOR R-Tx® Abutment Analogue Ø4



Ø mm	4
Order No.	68012443

LOCATOR R-Tx® Impression Coping

Order No.

68012444

LOCATOR R-Tx® Impression CopingPOM plastic⁶, non-sterile

The LOCATOR R-Tx® Impression Coping is used for transferring the LOCATOR R-Tx® Abutment position to the master model.

- Closed tray impression procedure
- Contains: 4 pcs
- Refer to instructions for use at www.zestdent.com

LOCATOR R-Tx® Retention Insert Tool

Order No.

68012446

LOCATOR R-Tx® Retention Insert ToolStainless steel³ / POM plastic⁶, non-sterile

The LOCATOR R-Tx® Retention Insert Tool is used for insertion and removal of the LOCATOR R-Tx® Retention Insert.

- Metal slot on the back of the tool for disengaging the retention insert
- Contains: a two-piece instrument
- Refer to instructions for use at www.zestdent.com

10. Restorative instruments

Hex Driver Manual

Stainless steel³, non-sterile

The hex driver is used for tightening screws, surgical and restorative components.

Hex Driver Manual



Total length mm	20	31
Order No.	25771	25772

Hex Driver

Stainless steel³, non-sterile

The hex driver is used for tightening screws, surgical and restorative components.

Hex Driver



Total length mm	20	24	35
Order No.	68015207	68015205	68015206

Atlantis Angulated Screw Access Screwdriver

Stainless steel³, non-sterile

The Atlantis Angulated Screw Access Screwdriver is used for components with Hex interface.

- Must be used in combination with Atlantis implant restorations that have been designed and manufactured with Angulated Screw Access on 1 or more connections
- Allows screw access up to 30 degrees

Every connection with angulated screw access is supplied with a corresponding Atlantis prosthetic screw.

Atlantis Angulated Screw Access Screwdriver



Total length mm	18	24	32
Order No.	36030	36031	36032

MultiBase Driver

Stainless steel³, non-sterile

The MultiBase driver is used for installation and removal of the MultiBase abutment.

- Restoration: screw retained
- Clinical use: multi-unit
- Contains: MultiBase Driver

MultiBase Driver



Total length mm	19
Order No.	68012244

Torque Wrench EV

Order No.	25774
-----------	-------

Torque Wrench EV

Stainless steel³, non-sterile

The torque wrench is used together with the surgical driver handle or the restorative driver handle for tightening and measuring the torque.

- Used together with the Surgical Driver Handle for implant installation and adjustment
- Used together with the Restorative Driver Handle for tightening abutments and/or bridge screws
- Multiple use
- Refer to instructions for use at www.elosmedtech.com

**Torque Wrench EV
Surgical Driver Handle**

Order No.	25775
-----------	-------

**Torque Wrench EV
Surgical Driver Handle**

Stainless steel³, non-sterile

The surgical driver handle is used together with the torque wrench and a surgical instrument.

- Multiple use

**Torque Wrench EV
Restorative Driver Handle**

Low

Order No.	25776	25777
-----------	-------	-------

**Torque Wrench EV
Restorative Driver Handle**

Stainless steel³, non-sterile

The restorative driver handle is used together with the torque wrench and a restorative instrument for tightening abutment and/or bridge screws.

- Multiple use

Atlantis FLO screwdriver

Order No.	34601
-----------	-------

Atlantis FLO screwdriver

Stainless steel³, non-sterile

Required for Atlantis FLO, used with lab-based scanning.

- Multiple use

Prosthetic Tray

PPSU plastic[®] / Silicone[®], non-sterile

The Prosthetic tray is used for sterilisation and storage of restorative instruments.

- Integrated silicone holders
- Scannable QR code for further information



Prosthetic Tray

Measurements mm	Length	Width	Height
	97.8	136.5	61.5
Order No.	68015288		

11. Appendix

Acuris conometric concept

Acuris is a paradigm shift in prosthetic retention of single crowns that are fixed yet retrievable by the clinician. The friction-based retention offers a fixation mode providing the aesthetics of a cement-retained crown, maintaining retrievability and excluding the risk of submucosal residual cement.

For further information and step-by-step procedures refer to [Acuris conometric concept manual](#).



Atlantis customised patient-specific restorations

As part of the digital implant solutions offered by Dentsply Sirona, Atlantis delivers patient-specific prosthetic solutions for all major implant systems* providing an excellent foundation for optimal function and aesthetics.

By utilising the unique design software, suprastructures, abutments and crowns will be individually designed from the final tooth shape. This is a significant advantage for achieving a more natural, aesthetic result and optimised function.

* For further information, compatible charts, manual and instructions, go to www.orderdigitalsolutions.com



Patient information material

With education comes knowledge – we offer a variety of easy-to-understand information material about implant treatment for your patients so that they can make an informed decision about their oral health.

Contact your Dentsply Sirona sales representative or customer service for more information.



WeldOne concept

The WeldOne concept provides a stable framework with a passive fit for immediate restorations, as temporary or durable prostheses, at the same day as the surgery.

For further information refer to [WeldOne concept manual](#).

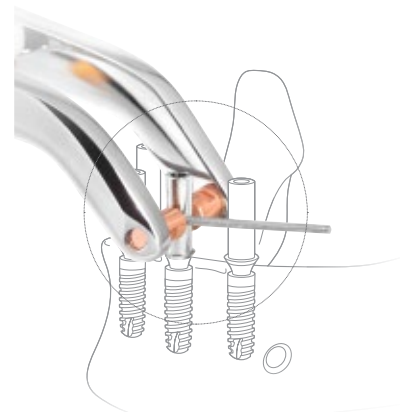

12. Material specifications

Index* will be found at material description for specific products.

Metals

Type	Index	Composition/Designation	Standard
Titanium alloy	1	Titanium-6Aluminum-4Vanadium	ASTM F136
Titanium	2	Pure titanium	ASTM F67
Stainless steel	3		ASTM F899
Gold-Platinum Alloy	4	Au 60%, Pd 20%, Pt 19%, Ir 1%	
TiCN Coated	5	Titanium Carbon Nitride	

Plastic

Type	Index	Composition/Designation	Standard
POM plastic	6	Polyoxymethylene	
PEEK plastic	7	Polyetheretherketon	
PPSU plastic	8	Polyphenylsulfone	
Silicone	9		
PMMA plastic	10	Polymethylenemethacrylate	
PP plastic	11	Polypropylene	
PA plastic	12	Polyamide	
PE plastic	13	Polyethylene	

13. Index

By order number

Order No.		page
25771	Hex Driver 20mm manual.....	38
25772	Hex Driver 31mm manual.....	38
25774	Torque Wrench EV.....	39
25775	Torque Wrench EV Surgical Driver Handle.....	39
25776	Torque Wrench EV Restorative Driver Handle.....	39
25777	Torque Wrench EV Restorative Driver Handle Low.....	39
34593	Atlantis FLO P-01 (XS).....	22
34594	Atlantis FLO P-02 (S).....	22
34595	Atlantis FLO P-03 (M).....	22
34596	Atlantis FLO P-04 (L).....	22
34597	Atlantis FLO P-05 (XL).....	22
34601	Atlantis FLO Screwdriver.....	39
35243	Atlantis IO FLO IO P-01 (XS).....	22
35244	Atlantis IO FLO IO P-02 (S).....	22
35245	Atlantis IO FLO IO P-03 (M).....	22
35246	Atlantis IO FLO IO P-04 (L).....	22
35247	Atlantis IO FLO IO P-05 (XL).....	22
36030	Atlantis screwdriver-ASA 18mm.....	38
36031	Atlantis screwdriver-ASA 24mm.....	38
36032	Atlantis screwdriver-ASA 32mm.....	38
68010001	Cover Screw EV (XS).....	16
68010002	Cover Screw EV (S).....	16
68010005	Cover Screw EV (M).....	16
68010006	Cover Screw EV (L).....	16
68010007	Cover Screw EV (XL).....	16
68012001	TiDesign EV (XS) Ø4.0 1.5mm.....	24
68012002	TiDesign EV (XS) Ø4.0 2.5mm.....	24
68012003	TiDesign EV (XS) Ø4.0 3.5mm.....	24
68012004	TiDesign EV (XS) Ø4.0 4.5mm.....	24
68012005	TiDesign EV (XS) Ø4.0 1.5mm 15°.....	24
68012006	TiDesign EV (XS) Ø4.0 2.5mm 15°.....	24
68012007	TiDesign EV (XS) Ø4.0 3.5mm 15°.....	24
68012008	TiDesign EV (XS) Ø4.0 4.5mm 15°.....	24
68012009	TiDesign EV (S) Ø4.5 1.5mm.....	24
68012010	TiDesign EV (S) Ø4.5 2.5mm.....	24
68012011	TiDesign EV (S) Ø4.5 3.5mm.....	24
68012012	TiDesign EV (S) Ø4.5 4.5mm.....	24
68012017	TiDesign EV (S) Ø4.5 1.5mm 15°.....	24
68012018	TiDesign EV (S) Ø4.5 2.5mm 15°.....	24
68012019	TiDesign EV (S) Ø4.5 3.5mm 15°.....	24
68012020	TiDesign EV (S) Ø4.5 4.5mm 15°.....	24
68012025	TiDesign EV (S) Ø5.5 1.5mm Tri.....	25
68012042	TiDesign EV (M) Ø5.5 1.5mm.....	25
68012043	TiDesign EV (M) Ø5.5 2.5mm.....	25
68012044	TiDesign EV (M) Ø5.5 3.5mm.....	25
68012045	TiDesign EV (M) Ø5.5 4.5mm.....	25
68012046	TiDesign EV (M) Ø5.5 1.5mm 15°.....	25
68012047	TiDesign EV (M) Ø5.5 2.5mm 15°.....	25
68012048	TiDesign EV (M) Ø5.5 3.5mm 15°.....	25
68012049	TiDesign EV (M) Ø5.5 4.5mm 15°.....	25
68012050	TiDesign EV (M) Ø5.5 1.5mm Tri.....	25
68012051	TiDesign EV (M) Ø7.0 1.5mm Tri.....	25
68012052	TiDesign EV (L) Ø7.0 1.5mm.....	25
68012053	TiDesign EV (L) Ø7.0 2.5mm.....	25
68012054	TiDesign EV (L) Ø7.0 3.5mm.....	25
68012055	TiDesign EV (L) Ø7.0 4.5mm.....	25
68012056	TiDesign EV (L) Ø5.5 1.5mm 15°.....	25
68012057	TiDesign EV (L) Ø5.5 2.5mm 15°.....	25
68012058	TiDesign EV (L) Ø5.5 3.5mm 15°.....	25
68012059	TiDesign EV (L) Ø5.5 4.5mm 15°.....	25
68012060	TiDesign EV (L) Ø5.5 1.5mm Tri.....	25
68012061	TiDesign EV (L) Ø7.0 1.5mm Tri.....	25
68012062	TiDesign EV (XL) Ø7.0 1.5mm.....	26
68012063	TiDesign EV (XL) Ø7.0 2.5mm.....	26
68012064	TiDesign EV (XL) Ø7.0 1.5mm 15°.....	26
68012065	TiDesign EV (XL) Ø7.0 2.5mm 15°.....	26
68012077	CastDesign EV (S).....	26

Order No.		page
68012078	CastDesign EV (M).....	26
68012079	CastDesign EV (L).....	26
68012080	CastDesign EV (XL).....	26
68012081	TitaniumBase EV (XS) 1mm.....	27
68012082	TitaniumBase EV (XS) 2mm.....	27
68012083	TitaniumBase EV (S) 1mm.....	27
68012084	TitaniumBase EV (S) 2mm.....	27
68012088	TitaniumBase EV (M) 1mm.....	27
68012089	TitaniumBase EV (M) 2mm.....	27
68012090	TitaniumBase EV (L) 1mm.....	27
68012091	TitaniumBase EV (L) 2mm.....	27
68012092	TitaniumBase EV (XL) 1mm.....	27
68012093	TitaniumBase EV (XL) 2mm.....	27
68012166	Abutment Screw EV (XS).....	19
68012167	Abutment Screw EV (S).....	19
68012168	Abutment Screw EV (M).....	19
68012169	Abutment Screw EV (L).....	19
68012170	Abutment Screw EV (XL).....	19
68012171	MultiBase Abutment EV (XS) 1.5mm NI.....	28
68012172	MultiBase Abutment EV (XS) 2.5mm NI.....	28
68012173	MultiBase Abutment EV (XS) 3.5mm NI.....	28
68012174	MultiBase Abutment EV (S) 1.5mm NI.....	28
68012175	MultiBase Abutment EV (S) 2.5mm NI.....	28
68012176	MultiBase Abutment EV (S) 3.5mm NI.....	28
68012177	MultiBase Abutment EV (S) 4.5mm NI.....	28
68012178	MultiBase Abutment EV (S) 1.5mm 17°.....	28
68012179	MultiBase Abutment EV (S) 2.5mm 17°.....	28
68012180	MultiBase Abutment EV (S) 3.5mm 17°.....	28
68012181	MultiBase Abutment EV (S) 4.5mm 17°.....	28
68012182	MultiBase Abutment EV (S) 1.5mm 17° NI.....	28
68012183	MultiBase Abutment EV (S) 2.5mm 17° NI.....	28
68012184	MultiBase Abutment EV (S) 3.5mm 17° NI.....	28
68012185	MultiBase Abutment EV (S) 4.5mm 17° NI.....	28
68012186	MultiBase Abutment EV (S) 1.5mm 30°.....	28
68012187	MultiBase Abutment EV (S) 2.5mm 30°.....	28
68012190	MultiBase Abutment EV (S) 1.5mm 30° NI.....	28
68012191	MultiBase Abutment EV (S) 2.5mm 30° NI.....	28
68012194	MultiBase Abutment EV (M) 1.5mm NI.....	29
68012195	MultiBase Abutment EV (M) 2.5mm NI.....	29
68012196	MultiBase Abutment EV (M) 3.5mm NI.....	29
68012197	MultiBase Abutment EV (M) 4.5mm NI.....	29
68012198	MultiBase Abutment EV (M) 1.5mm 17°.....	29
68012199	MultiBase Abutment EV (M) 2.5mm 17°.....	29
68012200	MultiBase Abutment EV (M) 3.5mm 17°.....	29
68012201	MultiBase Abutment EV (M) 4.5mm 17°.....	29
68012202	MultiBase Abutment EV (M) 1.5mm 17° NI.....	29
68012203	MultiBase Abutment EV (M) 2.5mm 17° NI.....	29
68012204	MultiBase Abutment EV (M) 3.5mm 17° NI.....	29
68012205	MultiBase Abutment EV (M) 4.5mm 17° NI.....	29
68012206	MultiBase Abutment EV (M) 1.5mm 30°.....	29
68012207	MultiBase Abutment EV (M) 2.5mm 30°.....	29
68012208	MultiBase Abutment EV (M) 1.5mm 30° NI.....	29
68012209	MultiBase Abutment EV (M) 2.5mm 30° NI.....	29
68012210	MultiBase Abutment EV (L) 1.5mm NI.....	30
68012211	MultiBase Abutment EV (L) 2.5mm NI.....	30
68012212	MultiBase Abutment EV (L) 3.5mm NI.....	30
68012213	MultiBase Abutment EV (L) 4.5mm NI.....	30
68012214	MultiBase Abutment EV (L) 1.5mm 17°.....	30
68012215	MultiBase Abutment EV (L) 2.5mm 17°.....	30
68012216	MultiBase Abutment EV (L) 3.5mm 17°.....	30
68012217	MultiBase Abutment EV (L) 4.5mm 17°.....	30
68012218	MultiBase Abutment EV (L) 1.5mm 17° NI.....	30
68012219	MultiBase Abutment EV (L) 2.5mm 17° NI.....	30
68012220	MultiBase Abutment EV (L) 3.5mm 17° NI.....	30
68012221	MultiBase Abutment EV (L) 1.5mm 30°.....	30
68012222	MultiBase Abutment EV (L) 2.5mm 30°.....	30
68012223	MultiBase Abutment EV (L) 1.5mm 30° NI.....	30

Order No.	page
68012224	MultiBase Abutment EV (L) 2.5mm 30° NI.....30
68012225	MultiBase Abutment EV (XL) 1.5mm NI.....30
68012226	MultiBase Abutment EV (XL) 2.5mm NI.....30
68012227	MultiBase Abutment EV (XL) 3.5mm NI.....30
68012228	MultiBase Abutment EV (XL) 4.5mm NI.....30
68012229	MultiBase Abutment Head with holder31
68012230	MultiBase Heal Cap Ø5.4 4mm31
68012231	MultiBase Transfer31
68012232	MultiBase Pick-Up31
68012233	MultiBase Bridge Screw.....23
68012234	MultiBase Lab Abutment Pin 14mm.....33
68012235	MultiBase Lab Abutment Pin 18mm.....33
68012236	MultiBase Lab Abutment Pin 22mm.....35
68012237	MultiBase Lab Bridge Screw 4 pcs.....33
68012238	MultiBase Analogue.....33
68012239	MultiBase Temporary Cylinder32
68012240	MultiBase Burnout Cylinder.....32
68012241	Protection sleeve.....32
68012243	MultiBase Semi-Burnout Cylinder.....32
68012244	MultiBase Driver.....38
68012352	MultiBase Abutment EV (L) 4.5mm 17° NI.....30
68012414	LOCATOR R-Tx® Abutment EV (S) 1mm.....34
68012415	LOCATOR R-Tx® Abutment EV (S) 2mm.....34
68012416	LOCATOR R-Tx® Abutment EV (S) 3mm.....34
68012417	LOCATOR R-Tx® Abutment EV (S) 4mm.....34
68012418	LOCATOR R-Tx® Abutment EV (S) 5mm.....34
68012419	LOCATOR R-Tx® Abutment EV (S) 6mm.....34
68012420	LOCATOR R-Tx® Abutment EV (M) 1mm34
68012421	LOCATOR R-Tx® Abutment EV (M) 2mm.....34
68012422	LOCATOR R-Tx® Abutment EV (M) 3mm.....34
68012423	LOCATOR R-Tx® Abutment EV (M) 4mm.....34
68012424	LOCATOR R-Tx® Abutment EV (M) 5mm.....34
68012425	LOCATOR R-Tx® Abutment EV (M) 6mm.....34
68012426	LOCATOR R-Tx® Abutment EV (L) 1mm.....34
68012427	LOCATOR R-Tx® Abutment EV (L) 2mm.....34
68012428	LOCATOR R-Tx® Abutment EV (L) 3mm.....34
68012429	LOCATOR R-Tx® Abutment EV (L) 4mm.....34
68012430	LOCATOR R-Tx® Abutment EV (L) 5mm.....34
68012431	LOCATOR R-Tx® Abutment EV (L) 6mm.....34
68012432	LOCATOR R-Tx® Zero Retention Insert Grey 4 pcs.....35
68012433	LOCATOR R-Tx® Low Retention Insert Blue 4 pcs35
68012434	LOCATOR R-Tx® Medium Retention Insert Pink 4 pcs.....35
68012435	LOCATOR R-Tx® High Retention Insert Clear 4 pcs.....35
68012436	LOCATOR R-Tx® Low Retention Limited Range Insert Aqua 4 pcs.....35
68012437	LOCATOR R-Tx® Medium Retention Limited Range Insert Magenta 4 pcs.....35
68012438	LOCATOR R-Tx® High Retention Limited Range Insert Gold 4 pcs.....35
68012439	LOCATOR R-Tx® Mixed Retention Limited Range Processing Pack 2 pcs.....35
68012440	LOCATOR R-Tx® Processing Insert 4 pcs.....36
68012441	LOCATOR R-Tx® Block-Out Spacer 20 pcs.....36
68012442	LOCATOR R-Tx® Denture Attachment Processing Assembly 4 pcs.....35
68012443	LOCATOR R-Tx® Abutment Analog Ø4 4 pcs36
68012444	LOCATOR R-Tx® Impression Coping 4 pcs.....37
68012445	LOCATOR R-Tx® Processing Spacer 4 pcs.....37
68012446	LOCATOR R-Tx® Retention Insert Tool37
68013001	HealDesign EV (XS) Ø3.5 2.5mm.....16
68013002	HealDesign EV (XS) Ø3.5 3.5mm.....16
68013003	HealDesign EV (XS) Ø3.5 4.5mm.....16
68013004	HealDesign EV (XS) Ø3.5 6.5mm.....16
68013005	HealDesign EV (S) Ø4.0 2.5mm16
68013006	HealDesign EV (S) Ø4.0 3.5mm16
68013007	HealDesign EV (S) Ø4.0 4.5mm16
68013008	HealDesign EV (S) Ø4.0 6.5mm16

Order No.	page
68013009	HealDesign EV (S) Ø5.0 2.5mm16
68013010	HealDesign EV (S) Ø5.0 3.5mm16
68013011	HealDesign EV (S) Ø5.0 4.5mm16
68013012	HealDesign EV (S) Ø5.0 6.5mm16
68013013	HealDesign EV (S) Ø6.0 3.5mm16
68013014	HealDesign EV (S) Ø6.0 4.5mm16
68013015	HealDesign EV (M) Ø5.0 2.5mm.....17
68013016	HealDesign EV (M) Ø5.0 3.5mm.....17
68013017	HealDesign EV (M) Ø5.0 4.5mm.....17
68013018	HealDesign EV (M) Ø5.0 6.5mm.....17
68013019	HealDesign EV (M) Ø6.5 2.5mm.....17
68013020	HealDesign EV (M) Ø6.5 3.5mm.....17
68013021	HealDesign EV (M) Ø6.5 4.5mm.....17
68013022	HealDesign EV (M) Ø6.5 6.5mm.....17
68013023	HealDesign EV (L) Ø5.0 2.5mm.....17
68013024	HealDesign EV (L) Ø5.0 3.5mm.....17
68013025	HealDesign EV (L) Ø5.0 4.5mm.....17
68013026	HealDesign EV (L) Ø5.0 6.5mm.....17
68013027	HealDesign EV (L) Ø6.5 2.5mm.....17
68013028	HealDesign EV (L) Ø6.5 3.5mm.....17
68013029	HealDesign EV (L) Ø6.5 4.5mm.....17
68013030	HealDesign EV (L) Ø6.5 6.5mm.....17
68013031	HealDesign EV (L) Ø7.5 3.5mm.....17
68013032	HealDesign EV (L) Ø7.5 4.5mm.....17
68013033	HealDesign EV (XL) Ø6.5 2.5mm.....17
68013034	HealDesign EV (XL) Ø6.5 3.5mm.....17
68013035	HealDesign EV (XL) Ø6.5 4.5mm.....17
68013036	HealDesign EV (XL) Ø6.5 6.5mm.....17
68013037	HealDesign EV (XL) Ø7.5 3.5mm.....17
68013038	HealDesign EV (XL) Ø7.5 4.5mm.....17
68013039	HealDesign EV (S) Ø5.0 3.5mm Tri.....17
68013040	HealDesign EV (M) Ø5.0 3.5mm Tri.....17
68013041	HealDesign EV (M) Ø6.5 3.5mm Tri.....17
68013042	HealDesign EV (L) Ø5.0 3.5mm Tri.....17
68013043	HealDesign EV (L) Ø6.5 3.5mm Tri.....17
68013044	Healing Abutment EV (XS) 2mm.....18
68013045	Healing Abutment EV (XS) 3mm.....18
68013046	Healing Abutment EV (XS) 4mm.....18
68013047	Healing Abutment EV (XS) 6mm.....18
68013048	Healing Abutment EV (S) 2mm.....18
68013049	Healing Abutment EV (S) 3mm.....18
68013050	Healing Abutment EV (S) 4mm.....18
68013051	Healing Abutment EV (S) 6mm.....18
68013052	Healing Abutment EV (M) 2mm.....18
68013053	Healing Abutment EV (M) 3mm.....18
68013054	Healing Abutment EV (M) 4mm.....18
68013055	Healing Abutment EV (M) 6mm.....18
68013056	Healing Abutment EV (L) 2mm.....18
68013057	Healing Abutment EV (L) 3mm.....18
68013058	Healing Abutment EV (L) 4mm.....18
68013059	Healing Abutment EV (L) 6mm.....18
68013060	Healing Abutment EV (XL) 2mm.....18
68013061	Healing Abutment EV (XL) 3mm.....18
68013062	Healing Abutment EV (XL) 4mm.....18
68013063	Healing Abutment EV (XL) 6mm.....18
68013064	TempAbutment EV (XS).....19
68013066	TempAbutment EV (S).....19
68013070	TempAbutment EV (M).....19
68013072	TempAbutment EV (L).....19
68013074	TempAbutment EV (XL).....19
68014009	Implant Pick-Up EV Design (S) short.....20
68014010	Implant Pick-Up EV Design (M) short.....20
68014011	Implant Pick-Up EV Design (L) short.....20
68014012	Implant Pick-Up EV Design (XL) short.....20
68014013	Implant Pick-Up EV Design (XS) long20
68014014	Implant Pick-Up EV Design (S) long20
68014015	Implant Pick-Up EV Design (M) long20

Order No.	page
68014016	Implant Pick-Up EV Design (L) long20
68014017	Implant Pick-Up EV Design (XL) long20
68014018	Implant Transfer EV (S) short.....21
68014019	Implant Transfer EV (M) short.....21
68014020	Implant Transfer EV (L) short.....21
68014021	Implant Transfer EV (XL) short.....21
68014022	Implant Transfer EV (XS) long21
68014023	Implant Transfer EV (S) long21
68014024	Implant Transfer EV (M) long21
68014025	Implant Transfer EV (L) long21
68014026	Implant Transfer EV (XL) long21
68014029	Lab Abutment Screw EV (XS) 4 pcs23
68014030	Lab Abutment Screw EV (S) 4 pcs23
68014031	Lab Abutment Screw EV (M) 4 pcs23
68014032	Lab Abutment Screw EV (L) 4 pcs23

Order No.	page
68014033	Lab Abutment Screw EV (XL) 4 pcs23
68014034	Implant Analogue EV (XS)23
68014035	Implant Analogue EV (S)23
68014036	Implant Analogue EV (M)23
68014037	Implant Analogue EV (L)23
68014038	Implant Analogue EV (XL)23
68015205	Hex Driver 24mm38
68015206	Hex Driver 35mm38
68015207	Hex Driver 20mm38
68015288	Prosthetic Tray40
68020018	Atlantis IO FLO-S A04K (XS)22
68020019	Atlantis IO FLO-S A04L (S)22
68020020	Atlantis IO FLO-S A04M (M)22
68020021	Atlantis IO FLO-S A04N (L)22
68020022	Atlantis IO FLO-S A04O (XL)22

Index

Alphabetical order

Order No.	page
68012169	Abutment Screw EV (L).....19
68012168	Abutment Screw EV (M).....19
68012167	Abutment Screw EV (S).....19
68012170	Abutment Screw EV (XL).....19
68012166	Abutment Screw EV (XS).....19
34593	Atlantis FLO P-01 (XS).....22
34594	Atlantis FLO P-02 (S).....22
34595	Atlantis FLO P-03 (M).....22
34596	Atlantis FLO P-04 (L).....22
34597	Atlantis FLO P-05 (XL).....22
34601	Atlantis FLO Screwdriver.....39
35243	Atlantis IO FLO IO P-01 (XS).....22
35244	Atlantis IO FLO IO P-02 (S).....22
35245	Atlantis IO FLO IO P-03 (M).....22
35246	Atlantis IO FLO IO P-04 (L).....22
35247	Atlantis IO FLO IO P-05 (XL).....22
68020018	Atlantis IO FLO-S A04K (XS).....22
68020019	Atlantis IO FLO-S A04L (S).....22
68020020	Atlantis IO FLO-S A04M (M).....22
68020021	Atlantis IO FLO-S A04N (L).....22
68020022	Atlantis IO FLO-S A04O (XL).....22
36030	Atlantis screwdriver-ASA 18mm.....38
36031	Atlantis screwdriver-ASA 24mm.....38
36032	Atlantis screwdriver-ASA 32mm.....38
68012079	CastDesign EV (L).....26
68012078	CastDesign EV (M).....26
68012077	CastDesign EV (S).....26
68012080	CastDesign EV (XL).....26
68010006	Cover Screw EV (L).....16
68010005	Cover Screw EV (M).....16
68010002	Cover Screw EV (S).....16
68010007	Cover Screw EV (XL).....16
68010001	Cover Screw EV (XS).....16
68013015	HealDesign EV (M) Ø5.0 2.5mm.....17
68013016	HealDesign EV (M) Ø5.0 3.5mm.....17
68013040	HealDesign EV (M) Ø5.0 3.5mm Tri.....17
68013017	HealDesign EV (M) Ø5.0 4.5mm.....17
68013018	HealDesign EV (M) Ø5.0 6.5mm.....17
68013019	HealDesign EV (M) Ø6.5 2.5mm.....17
68013020	HealDesign EV (M) Ø6.5 3.5mm.....17
68013041	HealDesign EV (M) Ø6.5 3.5mm Tri.....18
68013021	HealDesign EV (M) Ø6.5 4.5mm.....17
68013022	HealDesign EV (M) Ø6.5 6.5mm.....17
68013023	HealDesign EV (L) Ø5.0 2.5mm.....17
68013024	HealDesign EV (L) Ø5.0 3.5mm.....17
68013042	HealDesign EV (L) Ø5.0 3.5mm Tri.....17
68013025	HealDesign EV (L) Ø5.0 4.5mm.....17
68013026	HealDesign EV (L) Ø5.0 6.5mm.....17
68013027	HealDesign EV (L) Ø6.5 2.5mm.....17
68013028	HealDesign EV (L) Ø6.5 3.5mm.....17
68013043	HealDesign EV (L) Ø6.5 3.5mm Tri.....17
68013029	HealDesign EV (L) Ø6.5 4.5mm.....17
68013030	HealDesign EV (L) Ø6.5 6.5mm.....17
68013031	HealDesign EV (L) Ø7.5 3.5mm.....17
68013032	HealDesign EV (L) Ø7.5 4.5mm.....17
68013005	HealDesign EV (S) Ø4.0 2.5mm.....16
68013006	HealDesign EV (S) Ø4.0 3.5mm.....16
68013007	HealDesign EV (S) Ø4.0 4.5mm.....16
68013008	HealDesign EV (S) Ø4.0 6.5mm.....16
68013009	HealDesign EV (S) Ø5.0 2.5mm.....16
68013010	HealDesign EV (S) Ø5.0 3.5mm.....16
68013039	HealDesign EV (S) Ø4.0 4.5mm Tri.....16
68013011	HealDesign EV (S) Ø5.0 4.5mm.....16
68013012	HealDesign EV (S) Ø5.0 6.5mm.....16
68013013	HealDesign EV (S) Ø6.0 3.5mm.....16
68013014	HealDesign EV (S) Ø6.0 4.5mm.....16
68013033	HealDesign EV (XL) Ø6.5 2.5mm.....17

Order No.	page
68013034	HealDesign EV (XL) Ø6.5 3.5mm.....17
68013035	HealDesign EV (XL) Ø6.5 4.5mm.....17
68013036	HealDesign EV (XL) Ø6.5 6.5mm.....17
68013037	HealDesign EV (XL) Ø7.5 3.5mm.....17
68013038	HealDesign EV (XL) Ø7.5 4.5mm.....17
68013001	HealDesign EV (XS) Ø3.5 2.5mm.....16
68013002	HealDesign EV (XS) Ø3.5 3.5mm.....16
68013003	HealDesign EV (XS) Ø3.5 4.5mm.....16
68013004	HealDesign EV (XS) Ø3.5 6.5mm.....16
68013056	Healing Abutment EV (L) 2mm.....18
68013057	Healing Abutment EV (L) 3mm.....18
68013058	Healing Abutment EV (L) 4mm.....18
68013059	Healing Abutment EV (L) 6mm.....18
68013052	Healing Abutment EV (M) 2mm.....18
68013053	Healing Abutment EV (M) 3mm.....18
68013054	Healing Abutment EV (M) 4mm.....18
68013055	Healing Abutment EV (M) 6mm.....18
68013048	Healing Abutment EV (S) 2mm.....18
68013049	Healing Abutment EV (S) 3mm.....18
68013050	Healing Abutment EV (S) 4mm.....18
68013051	Healing Abutment EV (S) 6mm.....18
68013060	Healing Abutment EV (XL) 2mm.....18
68013061	Healing Abutment EV (XL) 3mm.....18
68013062	Healing Abutment EV (XL) 4mm.....18
68013063	Healing Abutment EV (XL) 6mm.....18
68013044	Healing Abutment EV (XS) 2mm.....18
68013045	Healing Abutment EV (XS) 3mm.....18
68013046	Healing Abutment EV (XS) 4mm.....18
68013047	Healing Abutment EV (XS) 6mm.....18
68015207	Hex Driver 20mm.....38
25771	Hex Driver 20mm manual.....38
68015205	Hex Driver 24mm.....38
25772	Hex Driver 31mm manual.....38
68015206	Hex Driver 35mm.....38
68014037	Implant Analogue EV (L).....23
68014036	Implant Analogue EV (M).....23
68014035	Implant Analogue EV (S).....23
68014038	Implant Analogue EV (XL).....23
68014034	Implant Analogue EV (XS).....23
68014016	Implant Pick-Up EV Design (L) long.....20
68014011	Implant Pick-Up EV Design (L) short.....20
68014015	Implant Pick-Up EV Design (M) long.....20
68014010	Implant Pick-Up EV Design (M) short.....20
68014014	Implant Pick-Up EV Design (S) long.....20
68014009	Implant Pick-Up EV Design (S) short.....20
68014017	Implant Pick-Up EV Design (XL) long.....20
68014012	Implant Pick-Up EV Design (XL) short.....20
68014013	Implant Pick-Up EV Design (XS) long.....20
68014025	Implant Transfer EV (L) long.....21
68014020	Implant Transfer EV (L) short.....21
68014024	Implant Transfer EV (M) long.....21
68014019	Implant Transfer EV (M) short.....21
68014023	Implant Transfer EV (S) long.....21
68014018	Implant Transfer EV (S) short.....21
68014026	Implant Transfer EV (XL) long.....21
68014021	Implant Transfer EV (XL) short.....21
68014022	Implant Transfer EV (XS) long.....21
68014032	Lab Abutment Screw EV (L) 4 pcs.....23
68014031	Lab Abutment Screw EV (M) 4 pcs.....23
68014030	Lab Abutment Screw EV (S) 4 pcs.....23
68014033	Lab Abutment Screw EV (XL) 4 pcs.....23
68014029	Lab Abutment Screw EV (XS) 4 pcs.....23
68012443	LOCATOR R-Tx* Abutment Analog Ø4 4 pcs.....36
68012426	LOCATOR R-Tx* Abutment EV (L) 1mm.....34
68012427	LOCATOR R-Tx* Abutment EV (L) 2mm.....34
68012428	LOCATOR R-Tx* Abutment EV (L) 3mm.....34
68012429	LOCATOR R-Tx* Abutment EV (L) 4mm.....34

Order No.	page
68012430	LOCATOR R-Tx* Abutment EV (L) 5mm.....34
68012431	LOCATOR R-Tx* Abutment EV (L) 6mm.....34
68012420	LOCATOR R-Tx* Abutment EV (M) 1mm34
68012421	LOCATOR R-Tx* Abutment EV (M) 2mm.....34
68012422	LOCATOR R-Tx* Abutment EV (M) 3mm.....34
68012423	LOCATOR R-Tx* Abutment EV (M) 4mm.....34
68012424	LOCATOR R-Tx* Abutment EV (M) 5mm.....34
68012425	LOCATOR R-Tx* Abutment EV (M) 6mm.....34
68012414	LOCATOR R-Tx* Abutment EV (S) 1mm34
68012415	LOCATOR R-Tx* Abutment EV (S) 2mm.....34
68012416	LOCATOR R-Tx* Abutment EV (S) 3mm.....34
68012417	LOCATOR R-Tx* Abutment EV (S) 4mm.....34
68012418	LOCATOR R-Tx* Abutment EV (S) 5mm.....34
68012419	LOCATOR R-Tx* Abutment EV (S) 6mm.....34
68012441	LOCATOR R-Tx* Block-Out Spacer 20 pcs.....36
68012442	LOCATOR R-Tx* Denture Attachment Processing Assembly 4 pcs.....35
68012435	LOCATOR R-Tx* High Retention Insert Clear 4 pcs.....35
68012438	LOCATOR R-Tx* High Retention Limited Range Insert Gold 4 pcs.....35
68012444	LOCATOR R-Tx* Impression Coping 4 pcs.....37
68012446	LOCATOR R-Tx* Retention Insert Tool37
68012433	LOCATOR R-Tx* Low Retention Insert Blue 4 pcs35
68012436	LOCATOR R-Tx* Low Retention Limited Range Insert Aqua 4 pcs.....35
68012434	LOCATOR R-Tx* Medium Retention Insert Pink 4 pcs.....35
68012437	LOCATOR R-Tx* Medium Retention Limited Range Insert Magenta 4 pcs.....35
68012439	LOCATOR R-Tx* Mixed Retention Limited Range Processing Pack 2 pcs.....35
68012440	LOCATOR R-Tx* Processing Insert 4 pcs.....36
68012445	LOCATOR R-Tx* Processing Spacer 4 pcs.....36
68012432	LOCATOR R-Tx* Zero Retention Insert Grey 4 pcs.....35
68012214	MultiBase Abutment EV (L) 1.5mm 17°30
68012218	MultiBase Abutment EV (L) 1.5mm 17° NI30
68012221	MultiBase Abutment EV (L) 1.5mm 30°30
68012223	MultiBase Abutment EV (L) 1.5mm 30° NI30
68012210	MultiBase Abutment EV (L) 1.5mm NI.....30
68012215	MultiBase Abutment EV (L) 2.5mm 17°30
68012219	MultiBase Abutment EV (L) 2.5mm 17° NI.....30
68012222	MultiBase Abutment EV (L) 2.5mm 30°30
68012224	MultiBase Abutment EV (L) 2.5mm 30° NI.....30
68012211	MultiBase Abutment EV (L) 2.5mm NI.....30
68012216	MultiBase Abutment EV (L) 3.5mm 17°30
68012220	MultiBase Abutment EV (L) 3.5mm 17° NI.....30
68012212	MultiBase Abutment EV (L) 3.5mm NI.....30
68012217	MultiBase Abutment EV (L) 4.5mm 17°30
68012352	MultiBase Abutment EV (L) 4.5mm 17° NI.....30
68012213	MultiBase Abutment EV (L) 4.5mm NI.....30
68012198	MultiBase Abutment EV (M) 1.5mm 17°29
68012202	MultiBase Abutment EV (M) 1.5mm 17° NI.....29
68012206	MultiBase Abutment EV (M) 1.5mm 30°29
68012208	MultiBase Abutment EV (M) 1.5mm 30° NI.....29
68012194	MultiBase Abutment EV (M) 1.5mm NI.....29
68012199	MultiBase Abutment EV (M) 2.5mm 17°29
68012203	MultiBase Abutment EV (M) 2.5mm 17° NI.....29
68012207	MultiBase Abutment EV (M) 2.5mm 30°29
68012209	MultiBase Abutment EV (M) 2.5mm 30° NI.....29
68012195	MultiBase Abutment EV (M) 2.5mm NI.....29
68012200	MultiBase Abutment EV (M) 3.5mm 17°29
68012204	MultiBase Abutment EV (M) 3.5mm 17° NI.....29
68012196	MultiBase Abutment EV (M) 3.5mm NI.....29
68012201	MultiBase Abutment EV (M) 4.5mm 17°29
68012205	MultiBase Abutment EV (M) 4.5mm 17° NI.....29
68012197	MultiBase Abutment EV (M) 4.5mm NI.....29
68012178	MultiBase Abutment EV (S) 1.5mm 17°28
68012182	MultiBase Abutment EV (S) 1.5mm 17° NI.....28

Order No.	page
68012186	MultiBase Abutment EV (S) 1.5mm 30°28
68012190	MultiBase Abutment EV (S) 1.5mm 30° NI28
68012174	MultiBase Abutment EV (S) 1.5mm NI.....28
68012179	MultiBase Abutment EV (S) 2.5mm 17°28
68012183	MultiBase Abutment EV (S) 2.5mm 17° NI.....28
68012187	MultiBase Abutment EV (S) 2.5mm 30°28
68012191	MultiBase Abutment EV (S) 2.5mm 30° NI.....28
68012175	MultiBase Abutment EV (S) 2.5mm NI.....28
68012180	MultiBase Abutment EV (S) 3.5mm 17°28
68012184	MultiBase Abutment EV (S) 3.5mm 17° NI.....28
68012176	MultiBase Abutment EV (S) 3.5mm NI.....28
68012181	MultiBase Abutment EV (S) 4.5mm 17°28
68012185	MultiBase Abutment EV (S) 4.5mm 17° NI.....28
68012177	MultiBase Abutment EV (S) 4.5mm NI.....28
68012225	MultiBase Abutment EV (XL) 1.5mm NI.....30
68012226	MultiBase Abutment EV (XL) 2.5mm NI.....30
68012227	MultiBase Abutment EV (XL) 3.5mm NI.....30
68012228	MultiBase Abutment EV (XL) 4.5mm NI.....30
68012171	MultiBase Abutment EV (XS) 1.5mm NI.....28
68012172	MultiBase Abutment EV (XS) 2.5mm NI.....28
68012173	MultiBase Abutment EV (XS) 3.5mm NI.....28
68012229	MultiBase Abutment Head with holder31
68012238	MultiBase Analogue.....33
68012233	MultiBase Bridge Screw23
68012240	MultiBase Burnout Cylinder.....32
68012244	MultiBase Driver38
68012230	MultiBase Heal Cap Ø5.4 4mm31
68012234	MultiBase Lab Abutment Pin 14mm.....33
68012235	MultiBase Lab Abutment Pin 18mm.....33
68012236	MultiBase Lab Abutment Pin 22mm.....33
68012237	MultiBase Lab Bridge Screw 4 pcs.....33
68012232	MultiBase Pick-Up31
68012243	MultiBase Semi-Burnout Cylinder.....32
68012239	MultiBase Temporary Cylinder.....32
68012231	MultiBase Transfer.....31
68015288	Prosthetic Tray.....40
68012241	Protection sleeve.....32
68013072	TempAbutment EV (L).....19
68013070	TempAbutment EV (M).....19
68013066	TempAbutment EV (S).....19
68013074	TempAbutment EV (XL).....19
68013064	TempAbutment EV (XS).....19
68012056	TiDesign EV (L) Ø5.5 1.5mm 15°25
68012060	TiDesign EV (L) Ø5.5 1.5mm Tri.....25
68012057	TiDesign EV (L) Ø5.5 2.5mm 15°25
68012058	TiDesign EV (L) Ø5.5 3.5mm 15°25
68012059	TiDesign EV (L) Ø5.5 4.5mm 15°25
68012052	TiDesign EV (L) Ø7.0 1.5mm.....25
68012061	TiDesign EV (L) Ø7.0 1.5mm Tri.....25
68012053	TiDesign EV (L) Ø7.0 2.5mm.....25
68012054	TiDesign EV (L) Ø7.0 3.5mm.....25
68012055	TiDesign EV (L) Ø7.0 4.5mm.....25
68012042	TiDesign EV (M) Ø5.5 1.5mm.....25
68012046	TiDesign EV (M) Ø5.5 1.5mm 15°25
68012050	TiDesign EV (M) Ø5.5 1.5mm Tri.....25
68012043	TiDesign EV (M) Ø5.5 2.5mm.....25
68012047	TiDesign EV (M) Ø5.5 2.5mm 15°25
68012044	TiDesign EV (M) Ø5.5 3.5mm.....25
68012048	TiDesign EV (M) Ø5.5 3.5mm 15°25
68012045	TiDesign EV (M) Ø5.5 4.5mm.....25
68012049	TiDesign EV (M) Ø5.5 4.5mm 15°25
68012051	TiDesign EV (M) Ø7.0 1.5mm Tri.....25
68012009	TiDesign EV (S) Ø4.5 1.5mm.....24
68012017	TiDesign EV (S) Ø4.5 1.5mm 15°24
68012025	TiDesign EV (S) Ø5.5 1.5mm Tri.....24
68012010	TiDesign EV (S) Ø4.5 2.5mm.....24
68012018	TiDesign EV (S) Ø4.5 2.5mm 15°24

Index

Order No.		page
68012011	TiDesign EV (S) Ø4.5 3.5mm.....	24
68012019	TiDesign EV (S) Ø4.5 3.5mm 15°	24
68012012	TiDesign EV (S) Ø4.5 4.5mm.....	24
68012020	TiDesign EV (S) Ø4.5 4.5mm 15°	24
68012062	TiDesign EV (XL) Ø7.0 1.5mm.....	26
68012064	TiDesign EV (XL) Ø7.0 1.5mm 15°	26
68012065	TiDesign EV (XL) Ø7.0 2.5mm.....	26
68012065	TiDesign EV (XL) Ø7.0 2.5mm 15°	26
68012001	TiDesign EV (XS) Ø4.0 1.5mm.....	24
68012005	TiDesign EV (XS) Ø4.0 1.5mm 15°	24
68012002	TiDesign EV (XS) Ø4.0 2.5mm.....	24
68012006	TiDesign EV (XS) Ø4.0 2.5mm 15°	24
68012003	TiDesign EV (XS) Ø4.0 3.5mm.....	24
68012007	TiDesign EV (XS) Ø4.0 3.5mm 15°	24
68012004	TiDesign EV (XS) Ø4.0 4.5mm.....	24

Order No.		page
68012008	TiDesign EV (XS) Ø4.0 4.5mm 15°	24
68012090	TitaniumBase EV (L) 1mm.....	27
68012091	TitaniumBase EV (L) 2mm.....	27
68012088	TitaniumBase EV (M) 1mm.....	27
68012089	TitaniumBase EV (M) 2mm.....	27
68012083	TitaniumBase EV (S) 1mm.....	27
68012084	TitaniumBase EV (S) 2mm.....	27
68012092	TitaniumBase EV (XL) 1mm.....	27
68012093	TitaniumBase EV (XL) 2mm.....	27
68012081	TitaniumBase EV (XS) 1mm.....	27
68012082	TitaniumBase EV (XS) 2mm.....	27
25774	Torque Wrench EV	39
25776	Torque Wrench EV Restorative Driver Handle.....	39
25777	Torque Wrench EV Restorative Driver Handle Low.....	39
25775	Torque Wrench EV Surgical Driver Handle	39

ANZ clientservices@dentsplysirona.com www.dentsplysirona.com
 Australia [1300 552 929](tel:1300552929) | New Zealand [0800 336 877](tel:0800336877)

YOUR
 CONFIDENCE
 IS OUR
 INSPIRATION.

