

Astra Tech Implant System®

Clinical & laboratory manual

# Attachment-retained restorations

Astra Tech Implant System® EV

The Astra Tech Implant System EV is designed for ease of use and versatility in providing treatment solutions for your implant patients.

The foundation of this evolutionary system remains the unique Astra Tech Implant System BioManagement Complex, which has been proven to predictably provide long-term marginal bone maintenance and esthetic results.



# Astra Tech Implant System®

## CONTENTS

### Introduction – Astra Tech Implant System® EV

Restorative overview .....	4
Abutment overview .....	5
Complementary Instruments .....	5
Implant-abutment interface connection .....	6
Color coding .....	6
Pre-operative procedures .....	7
Clinical application .....	8

### Clinical and laboratory procedures

Healing procedure	
– Healing Uni EV .....	9
Final restoration	
– Locator™ Abutment EV .....	10
– Ball Abutment EV .....	12
– Uni Abutment EV/Atlantis® suprastructures .....	14
– Uni Abutment EV/OD Cylinder EV .....	16
Torque Wrench EV – restorative handling .....	18
Torque guide .....	20
Cleaning and sterilization .....	21

For more information also follow the manufacturer’s instructions:

#### **Zest Anchors**

- Instructions for use – Locator® Implant Attachment System
- Locator® Implant Attachment System, Technique Manual for detailed handling of the Locator™ Abutment

#### **Cendres Métaux**

- Attachment for prosthetic dentistry for detailed handling of the Dalbo® -PLUS Female part

This manual is designed for use by clinicians who have undergone at least basic prosthetic and in-clinic implant training. Staying current on the latest trends and treatment techniques in implant dentistry through continued education is the responsibility of the clinician.

All products may not be regulatory cleared/released/licensed in all markets. Please, contact the local Dentsply Sirona sales office for current product assortment and availability.

To improve readability for our customers, Dentsply Sirona does not use ® or ™ in body copy. However, Dentsply Sirona does not waive any right to the trademark and nothing herein shall be interpreted to the contrary.

Product illustrations are not to scale.

# Restorative overview

Digitally and conventionally processed restoration enable splinted implants

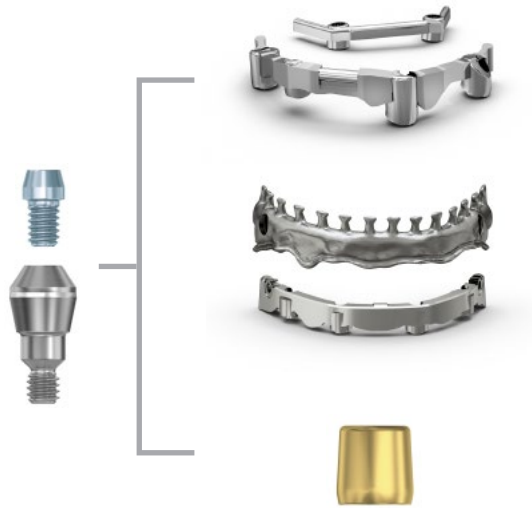

### Atlantis® Bar

Digitally processed bar supporting an overdenture in the mandible/maxilla.

### Atlantis® 2in1 (bridge and hybrid)

Digitally processed custom bar and a bridge-like or a hybrid-like secondary structure for friction retention in the mandible/maxilla.

### OD Cylinder EV

For removable overdentures in the mandible/maxilla on a conventional soldered bar in gold.

Conventional processed restorations for non-splinted implants



### Locator™ Abutment EV

For removable overdentures in the mandible.







### Ball Abutment EV

For removable overdentures in the mandible.

# Abutment overview



Astra Tech Implant System EV includes an abutment assortment, including patient-specific abutments and a wide range of prefabricated abutments designed to satisfy all implant indications. The abutments are produced in different materials in order to support

varying loading conditions and choice of permanent restoration. Throughout this manual, symbols are used to illustrate the indexings options. Below is a comprehensive overview of the abutments and symbols.

Final abutments	Indexing option	Recommended application	Features and benefits	Page
<b>Uni Abutment™ EV</b> Titanium 	Index free 	<ul style="list-style-type: none"> <li>Splinted restorations in the mandible/maxilla in combination with a bar</li> </ul>	<ul style="list-style-type: none"> <li>Compatible with Atlantis suprastructures</li> <li>One prosthetic connection for all implant interface connections</li> </ul>	14-17
<b>Locator™ Abutment EV</b> Titanium 	Index free 	<ul style="list-style-type: none"> <li>Non-splinted restorations in the mandible</li> </ul>	<ul style="list-style-type: none"> <li>Implant interface connections (3.6-4.8 mm)</li> </ul>	10-11
<b>Ball Abutment EV</b> Titanium 	Index free 	<ul style="list-style-type: none"> <li>Non-splinted restorations in the mandible</li> </ul>	<ul style="list-style-type: none"> <li>Implant interface connections (3.6-4.8 mm)</li> </ul>	12-13

## Complementary instruments

The different attachment-retained procedures require additional components and instruments to support in the varying stages of the treatment and laboratory processes.

Abutments	Instruments	
<b>Locator Abutment™ EV</b> 		Locator Driver EV Locator Core Tool Used for; <ul style="list-style-type: none"> <li>installation of the abutment</li> <li>placing and removing the inserts</li> </ul>
<b>Ball Abutment EV</b> 		Ball Abutment Driver EV Dalbo Plus Screwdriver/Activator Used for; <ul style="list-style-type: none"> <li>adjusting retention of and changing the inserts</li> </ul>
<b>Uni Abutment EV</b> 		Uni Driver EV Polishing Protector Uni EV Used for; <ul style="list-style-type: none"> <li>protecting the abutment when polishing the bar restoration</li> </ul>

## Implant size/tooth position

The design philosophy of the Astra Tech Implant System EV is based on the natural dentition utilizing a site-specific, crown-down approach supported by an intuitive surgical protocol and a simple prosthetic workflow.

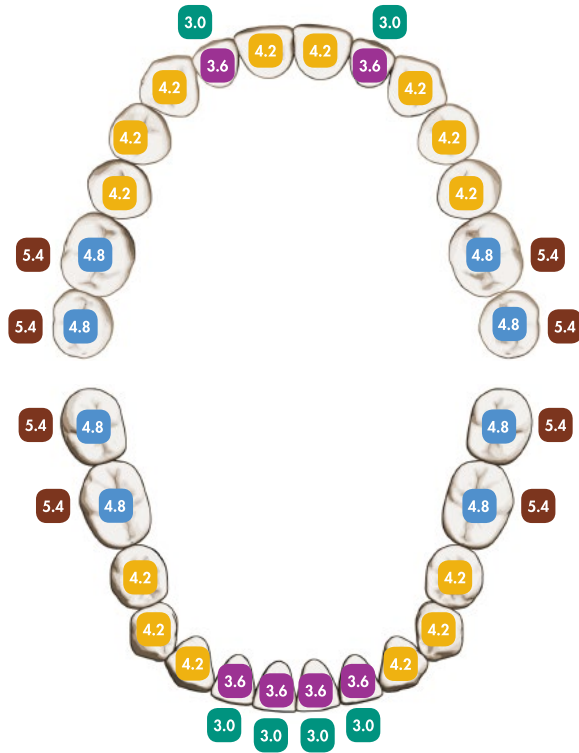

Multiple considerations are required for each tooth replacement, the support needed for the final restoration in the particular position, soft-tissue healing, and implant design and size.

The illustration indicates the recommended implant sizes in relation to the natural dentition, provided there is sufficient bone volume and space in relation to adjacent dentition.

## One system – one torque

All final abutments are designed for a uniform torque (25 Ncm), for added simplicity. A lower torque (15 Ncm) is applied on the restorative level for the bridge screw.

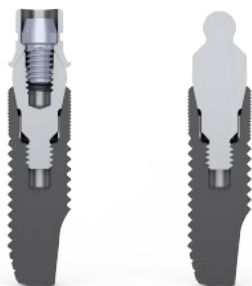

## Implant-abutment interface connection

The **OsseoSpeed EV** implant has a unique interface for one-position-only placement for restorative procedures and components, e.g. the Atlantis patient-specific abutments. The interface also allows for the flexibility of six-position indexing of prefabricated abutments, while index-free abutments can be seated in any rotational position.



OsseoSpeed EV

### Abutment placement option

#### One-position-only

Atlantis patient-specific, abutments will seat in one position only.



#### Six positions

Indexed abutments will seat in six available positions.



#### Index free

Index-free abutments will be seated in any rotational position.



## Color coding

Throughout the Astra Tech Implant System EV, markings, color coding and geometrical designs simplify the correct identification of corresponding components.

Each implant-abutment connection size is identified by a specific color, which is used consistently throughout the system. The color is applied directly to components and instruments, as well as on packaging and informational material, where appropriate.

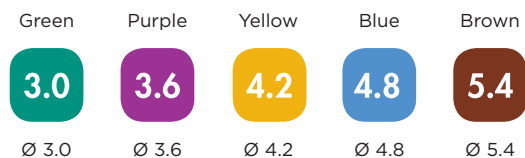

## Pre-operative procedures

### Pre-operative examination

An evaluation of the patient's general and oral health, with clinical and radiographic examinations, must be performed. Particular attention should be given to mucous membranes, jaw morphology, dental and prosthetic history, and signs of oral dysfunction.

Radiographic analysis should be used to evaluate bone topography of the residual alveolar process. The initial radiographic evaluation, together with the clinical examination, is the basis for determining whether or not a patient is a candidate for implant treatment.

If the patient is found to be suitable, a more thorough clinical examination of the area for treatment and the opposing jaw should be performed. Any local pathology in the jaws should be treated before implant placement.

### Pre-operative planning

Pre-operative planning should be based on the expected restorative treatment outcome. The Astra Tech Implant System EV assortment is designed to meet the prosthetic needs for the tooth replacement planned. The prosthetic versatility in materials, designs and sizes is aligned with the implant for support of the tooth replacements in the different positions in the jaw.

To achieve the expected outcome, treatment planning should include all stages of the procedure, from healing time and components to provisional and final restorations.

Today, digital processes with CBCT scans, together with optical surface scans, can replace or complement models mounted on an articulator and provide (analog or virtual) information of the relationship between jaws and teeth. A diagnostic wax-up with the missing teeth replaced provides important information in the planning phase. Based on analysis and evaluation of the occlusal table, force distribution and preferred sites for the implants, an optimal plan can be achieved. The transparent Radiographic Implant Guides displaying implants in different magnifications are helpful in planning optimal position, direction and implant size. When working in a digital environment, the planning software provides a library of the different implants.



Implant, the computer guided implant treatment software, can be used for the Astra Tech Implant System EV to ensure accurate planning for optimized implant position and placement.

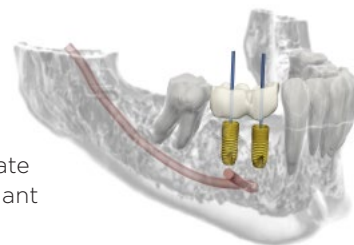

Even though the final treatment approach may be determined at the time of surgery, consider the following based on the quality of supporting bone and expected initial stability of the implant(s):

- One- or two-stage surgical procedure
- Immediate or early loading protocol
- Expected healing time before loading

When the prerequisites for immediate loading cannot be met, an early loading protocol (at least six weeks healing period) may be considered.

In all situations, bone quality and quantity, primary stability achieved, design of restoration, and loading conditions should be carefully examined and assessed by the clinician when determining time to loading of implants for each individual case.

Before treatment begins, the patient should be informed about the results of the pre-operative examination and given a clear explanation of what is entailed by the planned treatment, including the expected outcome, maintenance requirements and risks involved.

## Clinical application

The Astra Tech Implant System EV is designed to meet various clinical situations found in partially dentate and edentulous patients. It has been thoroughly investigated in numerous technical, experimental and prospective clinical studies, and the extensive research and documentation have yielded a simple, flexible and reliable implant system that is clinically proven to maintain marginal bone levels. A variety of prosthetic treatment options can be undertaken using implants as anchorage units.

There are several indications for overdenture treatment in connection with implant treatment. Functional, esthetic, phonetic and hygienic requirements in certain clinical situations support the use of the overdenture as a treatment option. The presence of at least one implant in each quadrant of the jaw, combined with a suitable attachment system, makes overdenture treatment a viable alternative when treating totally edentulous jaws.

### Attachment-retained treatment in the lower jaw

In the lower jaw, the installation of a fixed bridge restoration is often possible; however, patients sometimes prefer to have an overdenture for reasons of economics. Clinical studies with the Astra Tech Implant System show that the survival rate of implants in the lower jaw is the same for overdentures as for fixed bridge restorations, regardless of the retaining system.

The following protocol is recommended in the lower jaw:

- Minimum 2 implants, splinted or non-splinted

### Attachment-retained treatment in the upper jaw

In the upper jaw, the clinical result and long-term predictability is more dependent on the mode of implant support and the design of the denture. A prefabricated

or customized bar, splinting four or more implants can help to ensure equally good results as in the lower jaw.

The following protocol is recommended in the upper jaw:

- Minimum 4 implants, splinted

### Motives for attachment-retained treatment

- An unfavorable jaw relation which makes treatment with a fixed bridge restoration difficult
- Esthetic problems, e.g. the need for lip support in the upper jaw
- Phonetic problems due to loss of alveolar bone in the upper jaw
- Patient dissatisfaction with removable denture due to oral irritations and/or loss of bone for denture fixation
- A bridge option makes satisfactory oral hygiene impossible or extremely difficult to achieve
- Edentulous patients with a cleft palate
- Economic constraints

### Further factors to consider

Factors which govern the planning of the overdenture treatment are the number and length of the implants, together with quality and quantity of the anchoring bone tissue.

To ensure an optimized restorative treatment, make sure that the following conditions are met:

- Parallel implants
- Rigid bar connector without large distances between implants
- Appropriate length of extension bars, not too long
- Adequate resilience of the mucosa; the mucosa should not be too soft
- Provide an even load on the mucosa when the prosthesis is in function



Non-splinted attachments in the lower jaw.



Splinted attachments in the lower jaw.

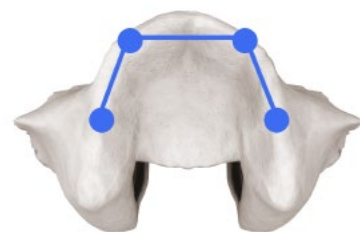

Splinted attachments in the upper jaw.



# Healing Uni EV

The healing components are developed to support the surrounding soft tissue and give a predictable treatment situation by geometries in close correspondence to the final abutments.

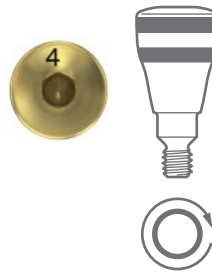

## Healing Uni EV

Healing Uni EV is used for soft tissue support during the healing phase and is designed to support and simplify final abutment selection

- Harmonized with the heights and diameters for all the attachment-retained abutments
- Laser etched bands for gauging
- Color: according to implant

## Clinical procedure

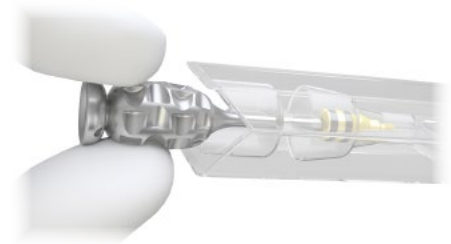
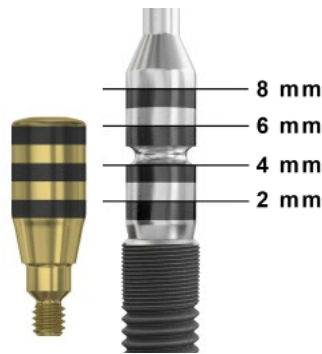

### Abutment Depth Gauge EV

- One tip design for each implant connection.
- A waist on the tip for identification of 4-5 mm depth mark.
- Color: according to implant.

### Measure height

- The abutment depth gauges corresponds with the Healing Uni EV laser etched bands.

### Installation

- Pick up and install the sterile Healing Uni EV directly from the blister package using the Hex Driver EV.
- Manually seat and secure the healing abutment using light finger force (5-10 Ncm).

# Locator™ Abutment EV

The Locator Abutment provides long-term stability and ease of use. The low vertical height is ideal for the majority of all overdenture patients. Cases with angulation problems and limited occlusal space can be easily corrected using Locator.



### Clinical application:

- Fully edentulous situations in the mandible.
- Taking into consideration clinical documentation available, non-splinted Locator Abutment EV solutions are recommended in the lower jaw only.

## Clinical procedure



### Abutment selection

Before abutment installation, remove the healing abutment and register the soft tissue height for proper selection of the permanent abutment. The appropriate height of the Locator Abutment EV is where the outer retention geometry is at a supra gingival height.

**Note:** Healing Uni EV design supports the permanent Locator Abutment EV configuration and creates a matching soft tissue contour.

### Installation

- Mount the Locator Abutment EV and the plastic holder/sleeve onto the driver, a part of the Locator Core Tool.
- Seat the Locator Abutment EV manually.
- Use the Locator Driver EV in the restorative Driver Handle EV with the Torque Wrench EV. Tighten the abutment to recommended torque (25 Ncm).



### Impression

- Firmly attach the Locator Abutment Pick-ups on the Locator Abutments EV and check to ensure that they are securely in place.
- Take the abutment-level impression in a standard or customized impression tray with an elastomeric impression material.
- Remove the impression once the impression material has set.
- Verify that the impression is correct and send it to the laboratory.

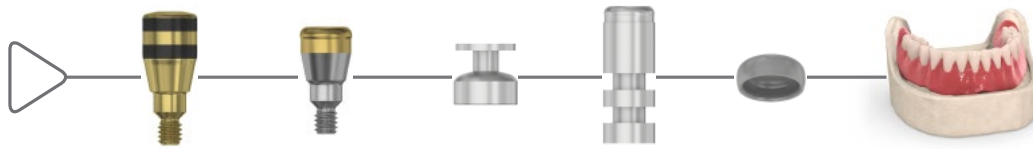

## Laboratory procedure



### Model

- Firmly place the Locator Abutment Replica into the Locator Abutment Pick-up in the impression.
- Fabricate a master model in high-quality stone material.
- Place the spacer over the head of each Locator Abutment Replica, mimicking the resilient situation, and attach the Locator Processing Caps to the replicas.

### Overdenture

- Fabricate the overdenture by curing the female part into the acrylic.
- Use a burr to remove excess acrylic, and polish the overdenture base.
- Remove the overdenture from the model and discard the black processing inserts using the Locator Insert Removal Tool, a part of the Locator Core Tool.

## Clinical procedure



### Final restoration

- Send the final overdenture with the Locator Abutment EV inserts to the clinician.
- Place the preferred Locator inserts into the metal housing (Processing Cap), using the Insert Seating Tool, a part of the Locator Core Tool.
- Check and adjust the final fit of the overdenture. Make corrections to the occlusion relation as needed.

# Ball Abutment EV

The Dalbo Plus female part TE basic is cured into the denture and custom retention is achieved with the adjustable Dalbo Plus Lamellae retention Insert E, seated into the housing. The insert is designed to reduce wear on the ball abutment and minimize the need for maintenance. Altering the retention of the Lamellae retention insert as well as changing to a new insert can be easily done using the Dalbo Plus Screwdriver/Activator.



### Clinical application:

- Fully edentulous situations in the mandible.
- Taking into consideration clinical documentation available, non-splinted Ball Abutments solutions are recommended in the lower jaw only.

## Clinical procedure



### Abutment selection

Before abutment installation, remove the healing abutment and register the mucosal height for proper selection of the permanent abutment. The appropriate height of the ball abutment is the highest point of the soft tissue margin corresponding at, or slightly "apical" to the tapered neck of the abutment.

**Note:** Healing Uni EV design supports the final Ball Abutment EV configuration and creates a matching soft tissue contour

### Abutment installation

- Attach the Ball Driver EV to the restorative Driver Handle EV.
- Attach the driver to the Ball Abutment EV.
- Connect the Ball Driver EV with the Torque Wrench EV. Tighten the abutment to the recommended torque (25 Ncm).



### Impression

- Take the abutment-level impression in a standard or customized impression tray with an elastomeric impression material.
- Remove the impression once the impression material has set.
- Verify that the impression is correct and send it to the laboratory.

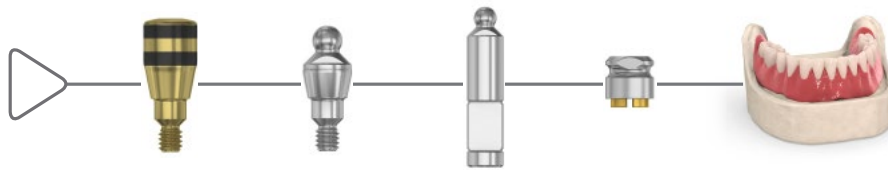

## Laboratory procedure

## Clinical procedure

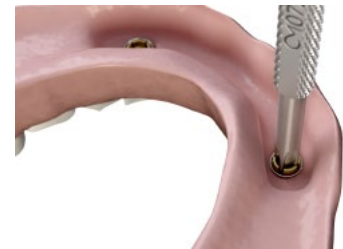

### Model

- Place the Ball Abutment EV Replica firmly into the impression. The parallel bevels on the abutment and the replica facilitates the positioning.
- Fabricate a master model with the ball replica and high-quality stone material.

### Overdenture

- Determine a common path of insertion for the ball attachment-retained overdenture.
- Place the duplicating aid onto the replica.
- Fabricate the overdenture.
- Remove the duplicating aid for making space in the prosthesis for the female part.
- Cure the female part into the acrylic.
- Use a burr to remove excess acrylic, polish the overdenture base.

### Final restoration

- Send the final overdenture to the clinician.
- The preferred retention of the inserts is adjusted to the patient's requirements. The activation is made with the Dalbo Plus Screwdriver/Activator by rotating clockwise, acquiring more retention, or counter clockwise acquiring less retention.
- Changing to a new or another insert is done with the screwdriver.
- Check and adjust the final fit of the overdenture. Make corrections to the occlusion relation as needed.

# Uni Abutment EV/Atlantis® suprastructures

A solid prosthetic interface with a 33° top cone and a M1.8 mm Bridge Screw. The design facilitates non-parallel implant situations up to 66°.

- Uni Abutment EV on all implant interface connections (3.0–5.4)

### Clinical application

- Partial and fully edentulous situations
- All positions in the mouth

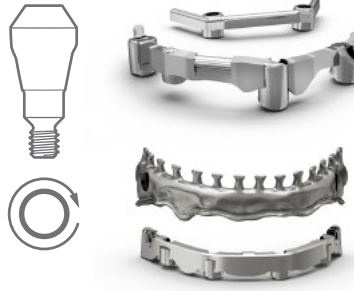

### Atlantis® Bar

Intended for removable prosthesis on standard or custom bars. A library of different bar profiles is available.

### Atlantis® 2in1 (bridge and hybrid)

Intended for removable prosthesis. The primary structure is a custom bar and the secondary structure can either be a bridge or a hybrid.

## Clinical procedure



### Abutment selection

- Before abutment installation, remove the healing abutment and register the mucosal height for proper selection of the permanent abutment.
- The permanent Uni Abutment EV can be selected either by aiming with the Abutment Depth Gauge EV or by indications on the Healing Uni EV.

**Note:** Healing Uni EV design supports the permanent Uni Abutment EV configuration and creates a matching soft tissue contour.

### Installation

- Attach the Uni Driver EV to the Driver Handle.
- Pick up the Uni Abutment EV with the driver by gently pressing the driver downwards. The driver is properly seated when it clicks.
- Seat the abutment manually.
- Tighten the abutment to the recommended torque (25 Ncm) with the restorative Driver handle EV, the Uni Driver EV and Torque Wrench EV.
- Release the driver using a small wiggling motion while lifting the driver gently.



### Impression

#### Open tray

- Select the appropriate Uni Abutment EV Pick-up.
- Place the pick-up using the Hex Screwdriver EV.
- Secure the pick-up using manual tightening torque (5–10 Ncm).
- Apply impression material around the pick-up separately.
- Place the tray, filled with impression material.
- Once the impression material has set, unscrew the pin and remove the impression.
- Check the impression for correct and stable retention of pick-up.

**Note:** For close tray impression technique use the Uni Abutment EV Transfer.



Laboratory procedure

Clinical procedure



Model making

- Connect the Uni Abutment EV Replica to the impression components and tighten without damaging the impression.
- Secure the Implant Pick-up EV using manual tightening torque (5-10 Ncm).
- Prepare the impression for duplication with a removable soft tissue mask by applying silicone around the replica.
- Pour high quality stone and fabricate the master model.

**Note:** Uni Abutment EV Replica is for single use.

Restoration fabrication

- Place the bar/structure on the model and tighten with Lab Bridge Screw EV.
- Fabricate the final restoration onto the secondary structure.
- Send the final restoration to the clinician.

Final restoration

- Install the the bar and tighten the bridge screws to the recommended torque (15 Ncm) with the restorative Driver handle EV, the Uni Driver EV and Torque Wrench EV.
- Check and adjust the final fit of the overdenture. Make corrections to the occlusion relation as needed.



# Uni Abutment EV/OD Cylinder EV – Bar solution

The OD cylinder in gold is developed to facilitate a conventional soldered bar solution, together with Uni Abutment EV as the connective base to the implant.

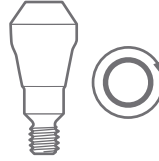

## Abutment selection

- Before abutment installation, remove the healing abutment and register the mucosal height for proper selection of the permanent abutment.
- The permanent Uni Abutment EV can be selected either by aiming with the Abutment Depth Gauge or by indications on the Healing Uni EV.

**Note:** Healing Uni EV design supports the permanent Uni Abutment EV configuration and creates a matching soft tissue contour.

## Installation

- Attach the Uni Driver EV to the restorative Driver Handle EV.
- Pick up the Uni Abutment EV with the driver by gently pressing the driver downwards. The driver is properly seated when it clicks.
- Seat the abutment manually.
- Tighten the abutment to recommended torque (25 Ncm) with the restorative driver handle, the driver and Torque Wrench EV.
- Release the driver using a small wiggling motion while lifting the driver gently.



## Impression Open Tray

- Select the appropriate Uni Abutment EV Pick-up.
- Install the pick-up using the Hex Screwdriver EV.
- Secure the pick-up using manual tightening torque (5-10 Ncm).
- Apply impression material on the pickup separately.
- Place the tray, filled with impression material.
- Once the impression material has set, unscrew the pin and remove the impression.
- Check the impression for correct and stable retention of pick-up.

**Note:** For closed tray impression technique, use the Uni Abutment EV Transfer.



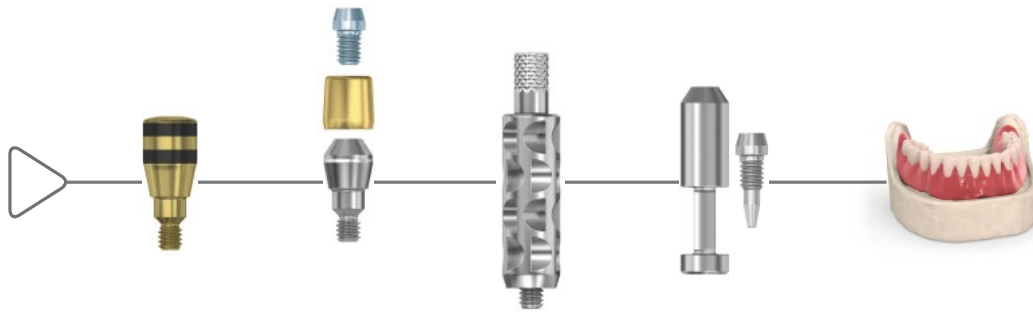

## Laboratory procedure



### Model making

- Connect the Uni Abutment Replica to the Uni Abutment EV Pick-up.
- Secure the pick-up using manual tightening torque (5-10 Ncm).
- Pour high quality stone in the impression and fabricate the model.

**Note:** Uni Abutment EV Replica is for single use.

### Restoration fabrication

- Place the OD Cylinder EV on the replica and tighten with a Lab Bridge Screw.
- Fit the bar (male part) and perform the soldering.
- Finish and thoroughly polish the bar restoration. Fit the clips (female parts) to the bar and fabricate the overdenture by curing the clips into the acrylic.
- Use a burr to remove excess acrylic, and polish the overdenture base.
- Send the final overdenture to the clinician.

Use bar and clips/riders of preferred choice.

### Final restoration

- Install the bar and tighten the bridge screws to the recommended torque (15 Ncm) with the restorative Driver Handle EV, the Uni Driver EV and Torque Wrench EV.
- Check and adjust the final fit of the overdenture. Make corrections to the occlusion relation as needed.



## Torque Wrench EV – restorative handling

A torque wrench together with a Restorative Driver Handle are used for tightening of abutment screws and/or bridge screws.

When used together with the Surgical Driver Handle, the torque wrench can also be used for implant installation and adjustment.

### Prosthetic instruments

Prosthetic instruments specifically designed for the Astra Tech Implant System EV.

- Hex Driver EV, manual and machine
- Ball Abutment Driver EV machine
- Locator Driver EV machine
- Uni Driver EV machine
- Torque Wrench EV
- Torque Wrench EV Restorative Driver Handle
- Torque Wrench EV Restorative Driver Handle Low



### Assemble

- Assemble the head of the wrench and the body by pushing the components together and turning them in opposite directions until there is an audible click.

### Attach

- Attach the Hex Driver EV into the Restorative Driver Handle EV and then into the wrench until there is an audible click.

### Handling

- Use a finger on the top of the driver handle to keep it steady and in place. Then gently pull the arm of the torque wrench in the direction of the arrow until the desired torque is achieved.

**Note:** The arm of the torque wrench must not go beyond the end of the scale, as this could result in inaccurate torque readings.

The arrow on the head of the wrench shows the direction in which the wrench is functioning.



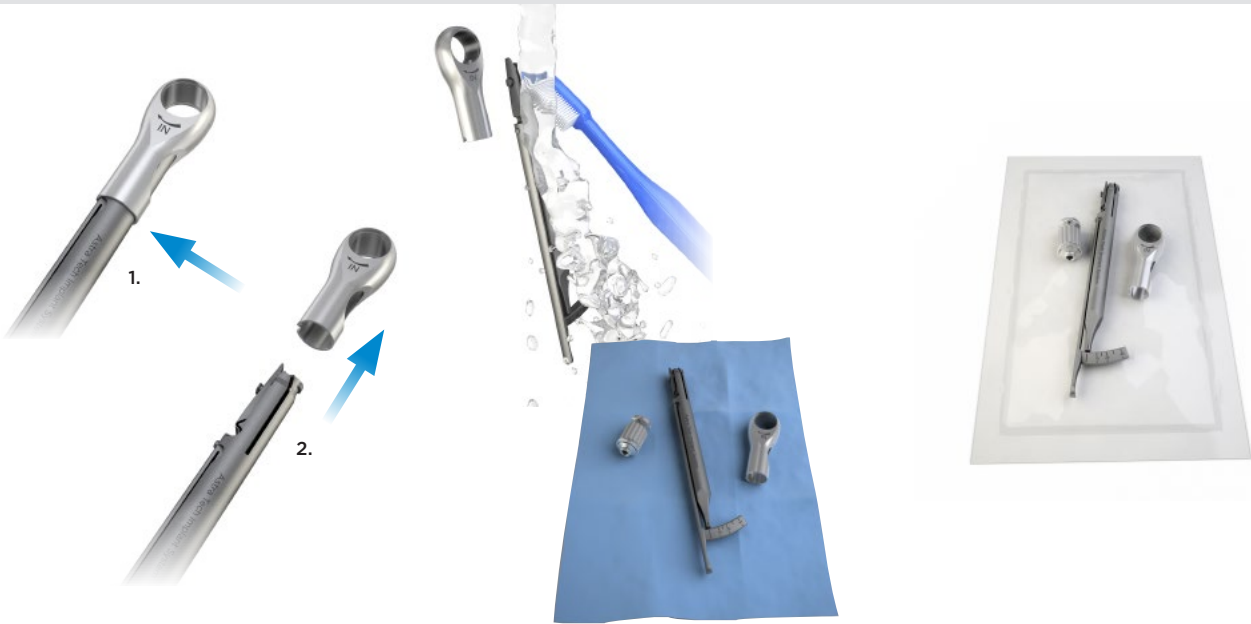

### Disassemble

- Remove the driver handle from the wrench.
- Remove the head by pressing a finger into the recess (1) and gently pulling the head (2).





### Cleaning and drying

- The three separated parts are now ready for cleaning using water and a brush. Let the parts dry.

### Sterilization

- Follow the manufacturer's instructions for use.

# Torque guide for Astra Tech Implant System® EV

Installation procedures	Recommended torque	
Implant installation	≤45 Ncm	
Healing components	Manual/light finger force (5-10 Ncm)	
Temporary restorations on all levels	15 Ncm	
Final restorations on implant level	25 Ncm	
Final restorations on abutment level	15 Ncm	

# Cleaning and sterilization

All drills, except the single use Precision Drill EV, can be used approximately ten times. If drills are not reused, dispose them in a sharps container immediately after the implant procedure is completed.

**Note:** Single use products should not be reused.

Remove residual tissue or bone debris by immersing the used products in lukewarm water (<math><40^{\circ}\text{C}/104^{\circ}\text{F}</math>). Do not use fixation agents or hot water as this could influence subsequent cleaning results. Products should be kept in a wet environment until the next step is initiated. For Direct Driver EV  $\varnothing$  3.3,  $\varnothing$  4 and Ball Abutment Driver EV storage in a wet environment is mandatory.

If cleaning is delayed more than 120 minutes, place the devices in a bath of a cleaning and disinfection solution to avoid drying of soil and/or debris, blood and other contaminations.

## Preparation for cleaning

Disassembly is required for the following products:

- Large Tray EV and Small Tray EV
- Impression components (pick-ups/transfers)

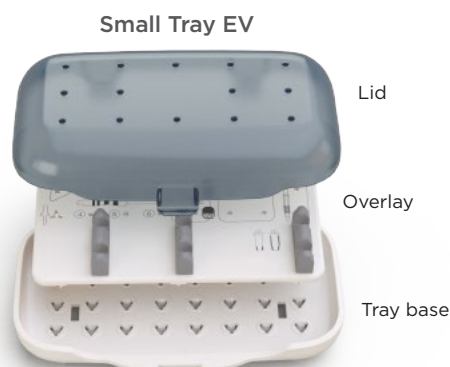
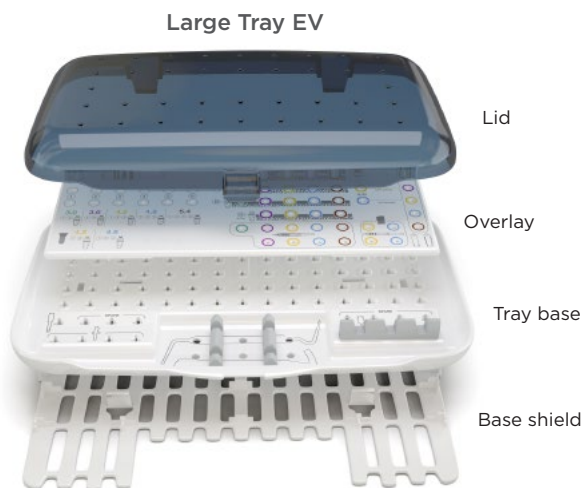

## Manual procedure

Apply detergent, Neodisher MediClean-Forte (Dr. Weigert, Hamburg) or similar solution to all surfaces. Scrub the outer and, if applicable, the inner side of the product with a soft bristled nylon brush until all visible soil and/or debris are removed. Flush the inner channels/lumen with cleaning solution using an irrigation needle connected to a syringe. Check channels/lumen for residual soil and/or debris. Run the products in an ultra-sonic bath with cleaning solution for minimum ten minutes. Drills and trays excluded. Rinse under clean running water until all trace of cleaning solution is removed. Flush the inner channels/lumen with water using an irrigation needle.

Prepare a bath with a disinfection solution, D212 instrument disinfection (DÜRR SYSTEM-HYGIENE) or similar, according to the detergent manufacturer's instructions. Immerse the products completely for the time specified by the manufacturer. Flush the internal channels/lumen using an irrigation needle for a minimum of 3 times. Rinse under clean running water until all trace of disinfection solution is removed. Flush the inner channels/lumen with water using an irrigation needle.

Dry the products using medical compressed air and clean lint-free single-use wipes.

## Automated procedure

Place instruments in a washer-disinfector, Vario TD or similar, according to recommendations from the supplier. Example of Vario TD washing program:

- Pre-wash, 20° C
- Cleaning with detergent, Neodisher MediClean-Forte (Dr. Weigert, Hamburg) or similar solution 45–55° C
- Neutralization
- Intermediate rinse
- Disinfection, >90° C (preferable 93° C), 5 min
- Drying

## Inspection and function testing

Drills shall be replaced as soon as their cutting capability diminishes. Discard blunt or damaged products.

## Packaging pre-sterilization

Thoroughly dry everything prior to the sterilization process to prevent the risk of corrosion. Assemble the tray and re-position the drills and instruments using drill/letter numbers, where applicable. It is recommended to wrap the instruments and tray according to the sterilization wrap manufacturer's instructions. It is recommended to place the abutments, screws, and applicable products in a sterilization bag.

**Note:** For US: Use FDA cleared sterilization bag and 16 minutes dry time at the end of the steam sterilization cycle.

## Sterilization

Steam sterilization with a pre-vacuum cycle (134°C/275°F for 3 minutes).

## Sterilization procedure for zirconia products

The products should not be sterilized in a steam autoclave. The process can affect the mechanical properties of the material.

## Statement Cleaning and sterilization of Astra Tech Implant System® EV products

The cleaning and sterilization instructions for Astra Tech Implant System EV assortment has been developed and validated by Dentsply Sirona. The instructions have been developed in accordance with the standards stated, please see below.

Both the VarioTD program (recommended for automated reprocessing) and the Neodisher Mediclean Forte (Dr. Weigert) detergent are recommendations and can be substituted with similar programs and detergents. For more information, please see <http://www.miele-professional.com> and/or [www.drweigert.com](http://www.drweigert.com).

Large Tray EV and Small Tray EV are made of PPSU (Polyphenylsulfone) material which may be sensitive for some chemicals containing acetate e.g. ethyl acetate. Consult your detergent manufacturer for compatibility of used detergent with PPSU if Neodisher Mediclean Forte is not used.

**For ZirDesign abutment:** Liquid Chemical Sterilization/ High Level Disinfection is recommended.

**Note:** For US: Dry heat (160°C/320°F for 4 hours) is the recommended procedure.

**For Atlantis abutment in zirconia:** Dry heat (160°C/320°F for 4 hours) is the recommended procedure.

## Storage

The products should be stored, in their package, in a dry place, at normal temperature (18–25°C/64–77°F). Use the sterilized components within the stated time period from the sterile bag manufacturer.

**Note:** For maintenance and cleaning of Contra Angles and Torque Wrench EV, follow the manufacturer's instructions.



If alternative procedures are used it is the responsibility of the user to ensure that the cleaning and sterilization procedure chosen achieves the desired results.

- ANSI/AAMI ST79:2010 & A1:2010 Comprehensive guide to steam sterilization and sterility assurance in health care facilities.
- ANSI/AAMI ST81:2004/(R) 2010 Sterilization of medical devices – Information to be provided by the manufacturer for the processing of resterilizable medical devices.
- AAMI TIR12:2010 Designing, testing, and labelling reusable medical devices for reprocessing in health care facilities: A guide for medical device manufacturers.
- EN ISO 17664:2004 Sterilization of medical devices – Information to be provided by the manufacturer for the processing of resterilizable medical devices.
- EN ISO 15883-1:2009, Washer-disinfectors – Part 1: General requirements, terms and definitions and tests.
- EN ISO 15883-2:2009, Washer-disinfectors – Part 2: Requirements and tests for washer-disinfectors employing thermal disinfection for surgical instruments, anaesthetic equipment, bowls, dishes, receivers, utensils, glassware, etc.
- ISO/TS 15883-5:2005, Washer-disinfectors – Part 5: Test soils and methods for demonstrating cleaning efficacy.
- EN ISO 17665-1:2006, Sterilization of health care products – Moist heat – Part 1: Requirements for the development, validation and routine control of a sterilization process for medical devices.



## About Dentsply Sirona Implants

Dentsply Sirona Implants offers comprehensive solutions for all phases of implant therapy, including Ankylos®, Astra Tech Implant System® and Xive® implant lines, digital technologies, such as Atlantis® patient-specific solutions and Simplant® guided surgery, Symbios® regenerative solutions, and professional and business development programs, such as STEPPS™. Dentsply Sirona Implants creates value for dental professionals and allows for predictable and lasting implant treatment outcomes, resulting in enhanced quality of life for patients.

## About Dentsply Sirona

Dentsply Sirona is the world's largest manufacturer of professional dental products and technologies, with a 130-year history of innovation and service to the dental industry and patients worldwide. Dentsply Sirona develops, manufactures, and markets a comprehensive solutions offering including dental and oral health products as well as other consumable medical devices under a strong portfolio of world class brands. As The Dental Solutions Company™, Dentsply Sirona's products provide innovative, high-quality and effective solutions to advance patient care and deliver better, safer and faster dentistry. Dentsply Sirona's global headquarters is located in York, Pennsylvania, and the international headquarters is based in Salzburg, Austria. The company's shares are listed in the United States on NASDAQ under the symbol XRAY.

Visit [www.dentsplysirona.com](http://www.dentsplysirona.com) for more information about Dentsply Sirona and its products.