

Ankylos®

Surgical Manual

General prosthetic advice for Ankylos®

In order to obtain utmost benefit from the unique restorative features of the Ankylos implant system, please observe the following guidelines:

- Avoid occlusal overload, aim for initial infra-occlusion to ensure clearance of contacts in function.
- If possible, use B-implants or larger for single molar restorations.
- Use gingiva height 0.75 and 1.5 only if really necessary, and in correspondence with thin gingiva.
- Minimize the functional occlusal surface in buccal-lingual dimension to avoid lateral levers.
- Take adequate precautions to avoid occlusal overload in correspondence to any prosthetic cantilevers.
- Bear in mind the resilience of neighboring teeth when planning for single tooth restorations. Establish full contact on the implant crown only during maximal clenching ensuring an even load distribution on all teeth during maximum chewing force.
- Check for parafunctional habits. Consider changes during recall appointments.
- In case of any changes to the occlusal scheme in other areas, evaluate the consequences for the implant restoration and, if required, take appropriate measures.
- Advice for the dental laboratory: The abutment design must not be manipulated at the areas of the connection taper or adjacent to the sulcus.

Please read this manual carefully before using the system for the first time and always observe the clinical indications, directions and notes in the instructions for use of the system components and instruments.

Furthermore, we recommend that all users attend a training course specific to the system prior to first using a new implant system.

Some products may not be available in all countries.

Please contact your Dentsply Sirona Implants representative to obtain up to date information on the product range and on availability.

To improve readability for our customers, Dentsply Sirona Implants does not use * or ™ in body copy. However, Dentsply Sirona Implants does not waive any right to the trademark and nothing herein shall be interpreted to the contrary.

CONTENTS

System concept

The structure-maintaining implant design	4
The prosthetic options	8

Treatment planning

Aspects of treatment planning	10
Conventional treatment planning	12
Computer-guided treatment planning	13

Implant surgery

Ankylos implant package	14
Ankylos surgical kits	16

Conventional preparation

Ankylos instrument set	18
Step-by-step: Preparation of the implant site	24
Step-by-step: Placement of the Ankylos C/X implants	28

Guided Surgery

Simplant SAFE Guides for Guided Surgery	32
Ankylos GS (Guided Surgery) instrument set	33
Step-by-step: Insertion of the Siplant SAFE Guides - Ankylos	38
Step-by-step: Preparation of the implant site	42
Step-by-step: Placement of the Ankylos C/X implants	45

Further treatment

Step-by-step: Transgingival healing	48
Step-by-step: Submerged healing	49
Step-by-step: Immediate restoration with short-term temporary denture	50
Step-by-step: Minimally invasive uncoverly	52

Options for surgery

Ankylos BoneExpander and BoneCondenser	54
Ankylos sinuslift instruments	56
Ankylos membrane screws	58

System concept

The structure-maintaining implant design

Discover Ankylos®

For more than 25 years, the Ankylos system with its TissueCare Connection using the taper principal has stood for successful long-term hard and soft-tissue stability and long-term red-white esthetics.

Ankylos® C/X implant diameters and lengths

Ankylos C/X implants are available in four diameters and various lengths. The practical size classification makes them suitable for all indications in dental implantology with a manageable number of implants.

∅ \ L	6.6 mm	8 mm	9.5 mm	11 mm	14 mm	17 mm
3.5 mm	A 6.6	A 8	A 9.5	A 11	A 14	A 17
4.5 mm	B 6.6	B 8	B 9.5	B 11	B 14	B 17
5.5 mm	C 6.6	C 8	C 9.5	C 11	C 14	C 17
7.0 mm		D 8	D 9.5	D 11	D 14	

Individual implants are identified by a capital letter that indicates the diameter and a number. The number shows the length of the implant in millimeters.

The color-coding on the implant package identifies the implant diameter. The instruments used to prepare the implant site are also color-coded.



The structure-maintaining Ankylos® thread design

The progressive Ankylos implant thread is perceptibly easier to screw into position and it also protects the tissue.

The Ankylos thread is specially designed to match the structure of the bone.

- The cervical geometry reduces load transfer to the cortical bone
- Continuously increasing thread depths transfer loads to the cancellous bone
- Maximum bone-to-implant contact in the final position
- Greatest possible tissue stability with crestal bone maintenance

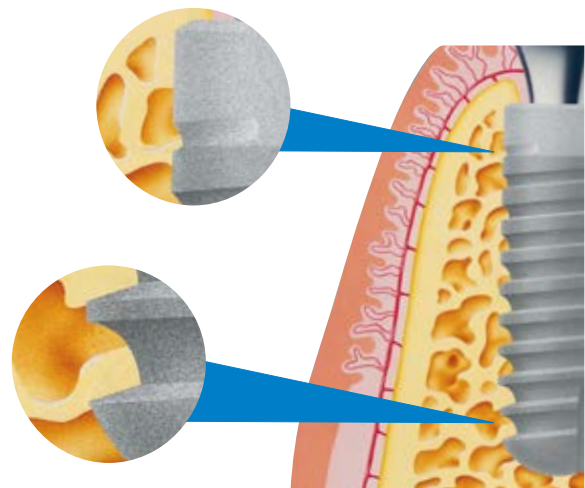

The design of the thread ensures an even pressure distribution in the bone crest and maintenance of the bone structure.

The structure-maintaining implant design

The growth-activating Friadent® plus implant surface

All Ankylos C/X implants have the innovative, growth-activating Friadent plus microstructure. The properties of the implant surface, which is designed to promote natural bone-healing processes, support the growth of bone-forming cells immediately after implant placement and ensure fast healing of the implants and homogenous osseointegration in the shortest possible time.

Friadent plus surface:

- Unique, three-dimensional microdesign that promotes the apposition of bone-forming cells and subsequently optimum osseointegration
- Intensive formation of new bone with increased bone maturation in the early stage for greater stability at the interface
- Improved bone quality for a predictable long-term success rate

Microstructured implant shoulder

The unique patented microstructure on the cervical margin and the implant shoulder promotes the apposition of bone cells. In the case of subcrestal implant positioning this means that bone can form even on the horizontal shoulder area. This provides additional support for the overlying soft tissue.

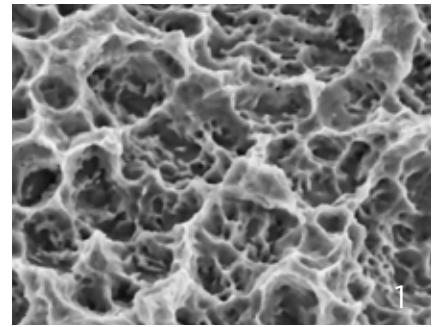

1 | SEM (3000 x) of Friadent plus surface structure. Bimodular morphology with micropores (0.5 - 1µm) in macrostructure.

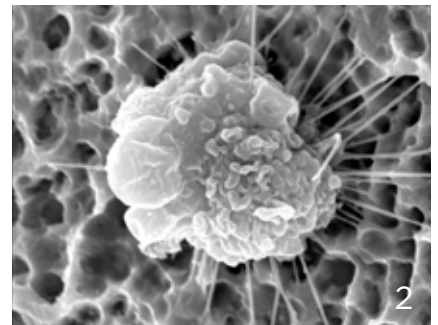

2 | Initial contact and anchorage of an osteoblast by thread-like extensions (filopodia) on the Friadent plus surface.

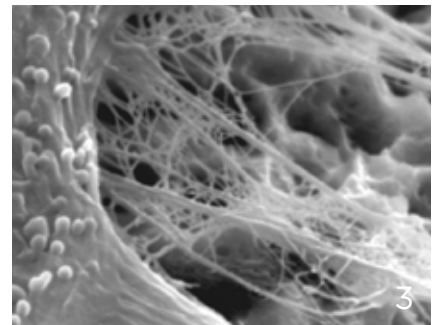

3 | Extracellular matrix on Friadent plus surface (fig. 1 - 3: R. Sammons et al.).

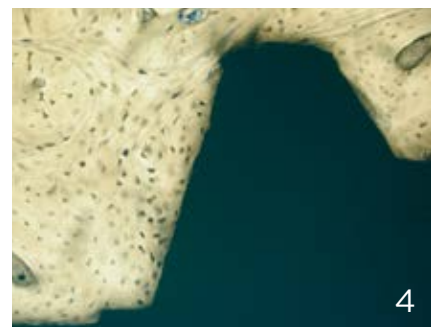

4 | Histology (10 x): Bone-to-implant contact on Friadent plus surface between the implant threads (fig. 4: M. Weinländer et al.).

Ankylos® TissueCare connection

The fully friction-locked and keyed Ankylos TissueCare connection provides excellent stability between implant and abutment.

The advantages are clear:

- No micromovement between implant and abutment. The virtual single-component implant design prevents mechanical irritation to the bone and maintains the peri-implant bone shown by Zipprich using a chewing simulator. No clinical data is available.

In combination with

- a subcrestal implant position and
- microroughness of the implants to the interface, the Ankylos TissueCare connection offers the best prospects for lasting red-white esthetics.

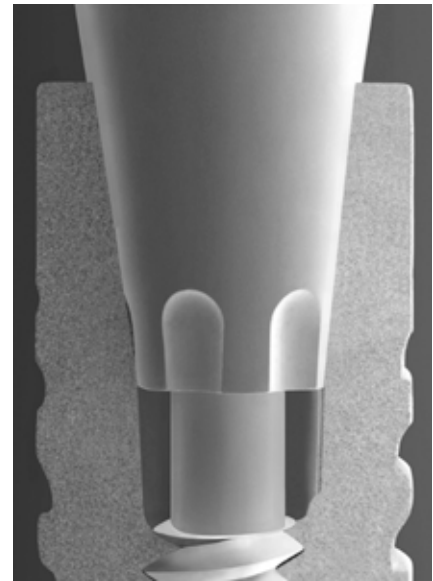

Apposition of bone tissue on the implant shoulder by subcrestal placement. Sulcus former in Ankylos implant, status three months after uncover (Histology: PD Dr. Dietmar Weng, Starnberg, Germany).

The prosthetic options

Ankylos® TissueCare Concept

The five success factors of the TissueCare Concept:

1. No micromovement between implant and abutment
2. Bacteria-proof connection
3. Platform-switching
4. Subcrestal implant placement
5. Microroughness to the interface

The Ankylos TissueCare Concept establishes space for dense, healthy soft tissue and natural looking implant-supported restorations.

For the patient's prosthetic restoration this means

- High functional loads, such as in the molar region, are safely transferred
- High security against loosening of retaining screws and abutments
- Cemented superstructure
- Long-term esthetics as a result of functional design

Minimally invasive uncover

Another advantage of the specially designed tapered connection for the surrounding soft tissue becomes clear when starting the prosthetic restoration.

The gingiva only requires minimal uncover without extended flap debridement. The hard and soft tissue on the implant margin is maintained.

For the patient, this means:

- Reduced surgical procedure
- Reduced treatment time
- Reduced treatment trauma

In many cases the option of transgingival healing makes a second surgical procedure quite unnecessary.

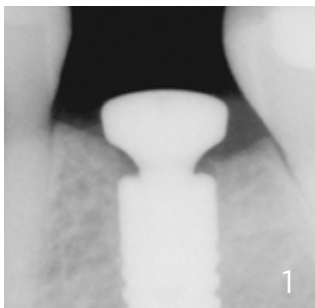

1 | Stable peri-implant hard tissue and soft tissue after uncover.

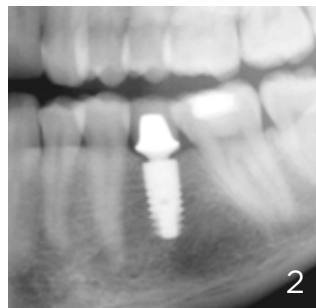

2 | 24 months after prosthetic restoration.



3 | 48 months after prosthetic restoration.



4 | Clinical situation (Photos: Dr. Nigel Saynor, Stockport, UK).

Freely combinable prosthetic abutment components

Prosthetic components for Ankylos C/X are available in different sizes and shapes with and without an index. A wide range of prosthetic situations can be managed for the best functional and esthetic results.

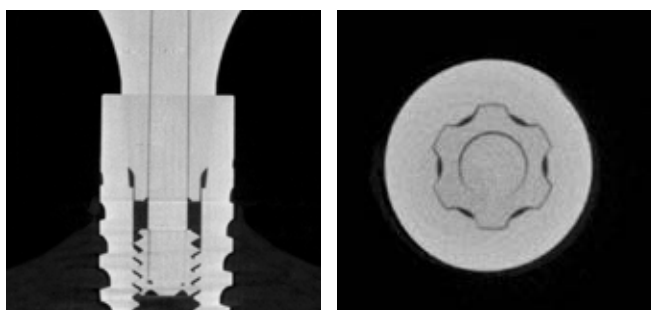

The identical size of the tapered connection means that any abutment fits into any implant of any diameter.

This means that

- Any abutment can be combined with any implant
- The number of prosthetic components is significantly reduced
- The options for implant-prosthetic therapy are significantly greater
- The diameter and length of implants can be selected exclusively on the basis of the bone volume
- The prosthetic abutment is selected entirely based on the prosthetic requirements

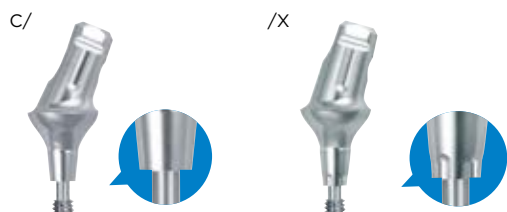

Ankylos® C/X prosthetics

Prosthetic abutments with tapered connection and index can be used when this is feasible. If free orientation of the abutment is of advantage, abutments with only the tapered connection can be used. The tapered connection ensures optimum stability and rotation locking for all components with or without index.

	Single-tooth crowns	Fixed bridges	Removable Protheses
Ankylos Regular C/ or /X	x	x	-
Ankylos Balance Anterior C/ or /X	x	x	-
Ankylos Cercon Balance C/	x ¹	-	-
Ankylos TitaniumBase C/ or /X	x	x	-
Atlantis Abutment for Ankylos C/ or /X	x	x	-
Ankylos Balance Base Abutment C/	-	x	x
Ankylos Standard Abutment C/	x	x	x
Ankylos SynCone C/	-	-	x ²
Ankylos Snap Attachment C/	-	-	x
Ankylos Locator C/	-	-	x

1 | Single-tooth restoration in the anterior region only (region 13-23 and 33-43)

2 | Immediate loading only in edentulous mandible on at least four interforaminal implants

All prosthetic abutments are laser-marked to indicate their use

- Components with the C/ mark use only the "C"one for the connection and are not indexed.
- Components with the /X mark are indexed. The index is used to position the abutment components in one of six possible positions.
- Components with the C/X mark are used for indexed or non-indexed prosthetics.

All components marked with C/X, C/ or /X fit into Ankylos C/X implants. Restorations based on Ankylos plus implants require components marked with C/ only or without any markings.

Treatment planning

Aspects of treatment planning

Precise planning for any implantological procedure in close coordination between practitioners and laboratory is the basic prerequisite for lasting therapeutic success. All suitable measures and alternatives that will fulfill the expectations of the patient in terms of function and esthetics of the implant prosthetic rehabilitation should be stipulated in the planning.

Today, along with conventional treatment planning, treatment can be planned using computer-guided facilities for three-dimensional “crown down” treatment with planning of the optimal implant placement from the point of view of the desired prosthetic restoration, both functionally and esthetically.



The basis of treatment planning is always a thorough discussion with the patient with a view towards determining the wishes and perceptions of the patient, excluding contraindications and clarifying matters thoroughly with the patient. Next, a complete general and specific medical history is taken and an intraoral diagnostic assessment is made with an analysis of the initial anatomical situation.

The following points should be taken into account:

- Medical history
- General diagnosis - elimination of contraindications
- Specialist consultation where there are risk factors
- Extensive intraoral diagnosis (PAR diagnosis, functional examination, reasons for tooth loss, assessment of the existing tooth replacement, radiological examination)

After all the diagnostic details have been submitted and evaluated, the treatment can be planned.

This comprises the following elements:

- Preprosthetic planning
- Surgical planning
- Schedule
- Cost projection

Conventional treatment planning

Preprosthetic planning

Preprosthetic planning with the dental technician is the most important factor for the esthetic and functional success of the implant procedure.

Surgical planning

During preoperative planning it is very important to check that the height and width of the jawbone is sufficient for placement of the implant.

The target is the best possible, tooth-analog placement of the implants. During the first planning session with the patient situation impressions are made to be used as the base for laboratory-fabricated diagnostic aids.

A diagnostic wax-up of the planned prosthetic restoration is made.

A thermoformed splint with radiographic balls that can be accurately repositioned in the patient's mouth is prepared. It can be subsequently modified to a conventionally fabricated surgical template.

The width of the vestibular and oral lamellae should be at least 1.5 mm after implant placement. The position and direction of important anatomical structures such as the mental foramen or maxillary sinus must be determined by radiology.

Grafted regions must be confirmed to have completely regenerated to a mechanically stable state before preparation.

Planned prosthetic measures must be checked to ensure that they can actually be implemented with appropriate surgical procedures. All aspects of preprosthetic and surgical planning interact directly with one another. Every change in the preprosthetic planning will affect the surgical planning and vice versa. This will also include the number, diameter, lengths, positions and alignment of the implants.

The available bone volume and important anatomical structures are examined in an x-ray image, which is prepared with the laboratory-fabricated x-ray template with the radiographic balls in the patient's mouth. The dimensions of the intraoral structures can be calculated from the defined diameter of the radiographic balls, taking the magnification factors resulting from radiological processes into account.

The implant lengths are selected by placing the transparent radiographic template on the OPG. If desired, the x-ray analysis must consider a subcrestal implant position (note magnification scale).

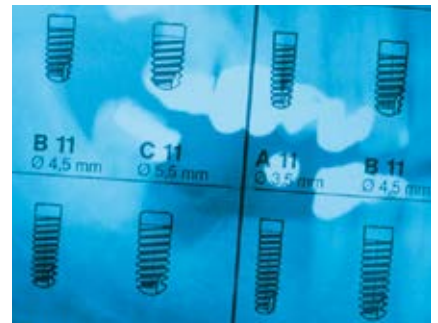

Computer-guided treatment planning

Digital treatment planning based on three-dimensional imaging procedures enables the therapy to be planned with the highest accuracy and makes the result of the treatment safe and predictable.

Dentsply Sirona Implants offers a complete solution for digital treatment planning and full-guided implant placement based on the world-renowned Simplant software.

The advantages over conventional planning include:

- Safe three-dimensional planning in the sub-millimeter range and with reference to the desired restoration
- Automatic collision control, which displays too narrow clearances between implants or to the nerve
- Information on peri-implant bone quality for accurate conclusions on the expected primary stability

An individual Simplant drill guide is fabricated using stereolithography, based on the digital planning data. Depending on the individual case scenario, the guide is prepared tooth-supported, mucosa-supported or bone-supported, thus enabling a complete and accurate transfer to the patient's mouth.

The Sleeve-on-Drill drill system, drills with a guide sleeve that can be attached to the instrument for precise guidance in the template, has been especially developed for template-guided implant placement in order to facilitate accurate, straight-forward implant placement with the added security of the drill stop.

These enable simpler and precisely fitting placement of the implants with the reliability of the drill stop.

Simplant drill guides are also available with lateral access for easier management of the instruments, even with a restricted oral cavity.

Digital treatment planning with Simplant.

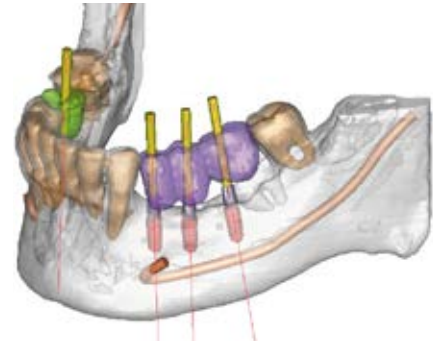

Patient-specific Simplant guide.



Sleeve-on-drill drill system and drill guide with lateral access.



Implant surgery

Ankylos[®] implant package

Ankylos C/X implants are supplied in double-sterile blister package with an outer carton. This type of package offers the maximum possible product safety in conformance with the increasingly rigid requirements for medical devices.

The packaging also makes it easy to store all products for quick retrieval and they are easy to handle during the surgical procedure.

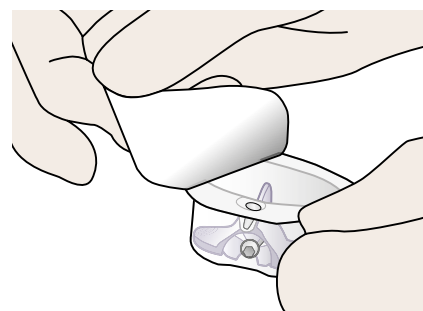
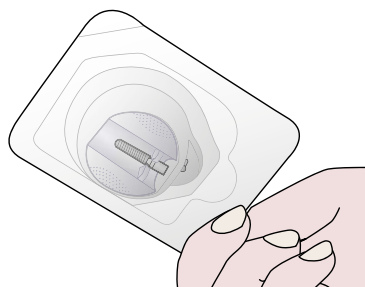

Outer box package

- Simple product classification with brand-specific design, sight window and imprint of the implant diameter
- Seal label with details of products
- Stackable, all important product information remains visible
- Includes multilingual instructions for use

Transparent outer blister

- Outer sterile barrier of implant package

Transparent inner blister

- Inner sterile package
- Contains implant shuttle with implant and cover screw for implants
- Peel-off label with batch number for reliable documentation of treatment

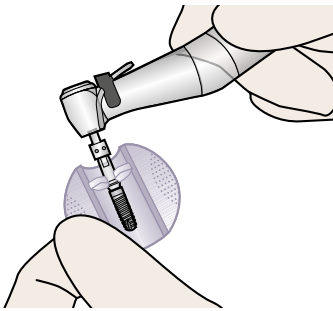

Plastic implant shuttle

- Holds the implant securely in the packaging and protects it from damage
- Makes non-contact transfer and acceptance of the implant easy during the operation
- Three wings with roughened surfaces for non-slip holding make it very easy to handle safely

Symbols on the package labels

STERILER

Sterilization using irradiation



Do not reuse

LOT

Batch code



Manufacturer

REF

Reference number



Expiration date



Keep away from sunlight



Class I medical devices in accordance with Directive 93/42/ECC



Keep dry



Consult instructions for use

CE 0123

Class IIa, IIb, III medical devices in accordance with Directive 93/42/ECC



Note for Russia

Russian certification marking in accordance with the Gos standard



Note for USA

Relevant symbols see product label

Ankylos[®] surgical kits

All instruments for surgical use of the Ankylos system are stored in Ankylos surgical kits, which are designed to make all instruments easily accessible and easy to clean and sterilize. The modular components of the trays with the minimum required number of instruments can be supplemented with additional modules for specific diameters.

The light plastic trays with organizers integrated into the cover for holding used instruments define a specific user sequence during surgery. All instruments are securely held in silicone holders.



The following Ankylos surgical kits are available:

Ankylos Surgical Kit motor AB:

Includes instruments for motor-driven placement of Ankylos A- and B-implants (diameter 3.5 and 4.5 mm).

Ankylos Surgical Kit manual AB or ABC:

Includes instruments for placement of Ankylos A- and B- or A-, B- and C-implants with manual final preparation. Instruments for motor-driven final preparation are only available for A- and B-implants. Like all other drill modules, a drill module for C- and D-implants (manual) can be ordered separately and added to the kit.



Ankylos Washtray

The washtray is an optional device for automated processing of instruments. It must not be used to process drills with internal irrigation (see "Instructions for Sterilization and Instrument Care" for details).



Ankylos Surgical Kit ExpertEase:

Includes instruments in L 8 - L 14 lengths for template-guided placement of Ankylos C/X A- and B-implants. The Sleeve-on-Drill sleeves required for use with Guided Surgery must be ordered separately.



Ankylos[®] instrument set

An essential precondition for a successful implant placement is accurate and atraumatic preparation of the bone at the implant site. The instrument set for the Ankylos implant system with its precisely designed shapes is ideal for these requirements.

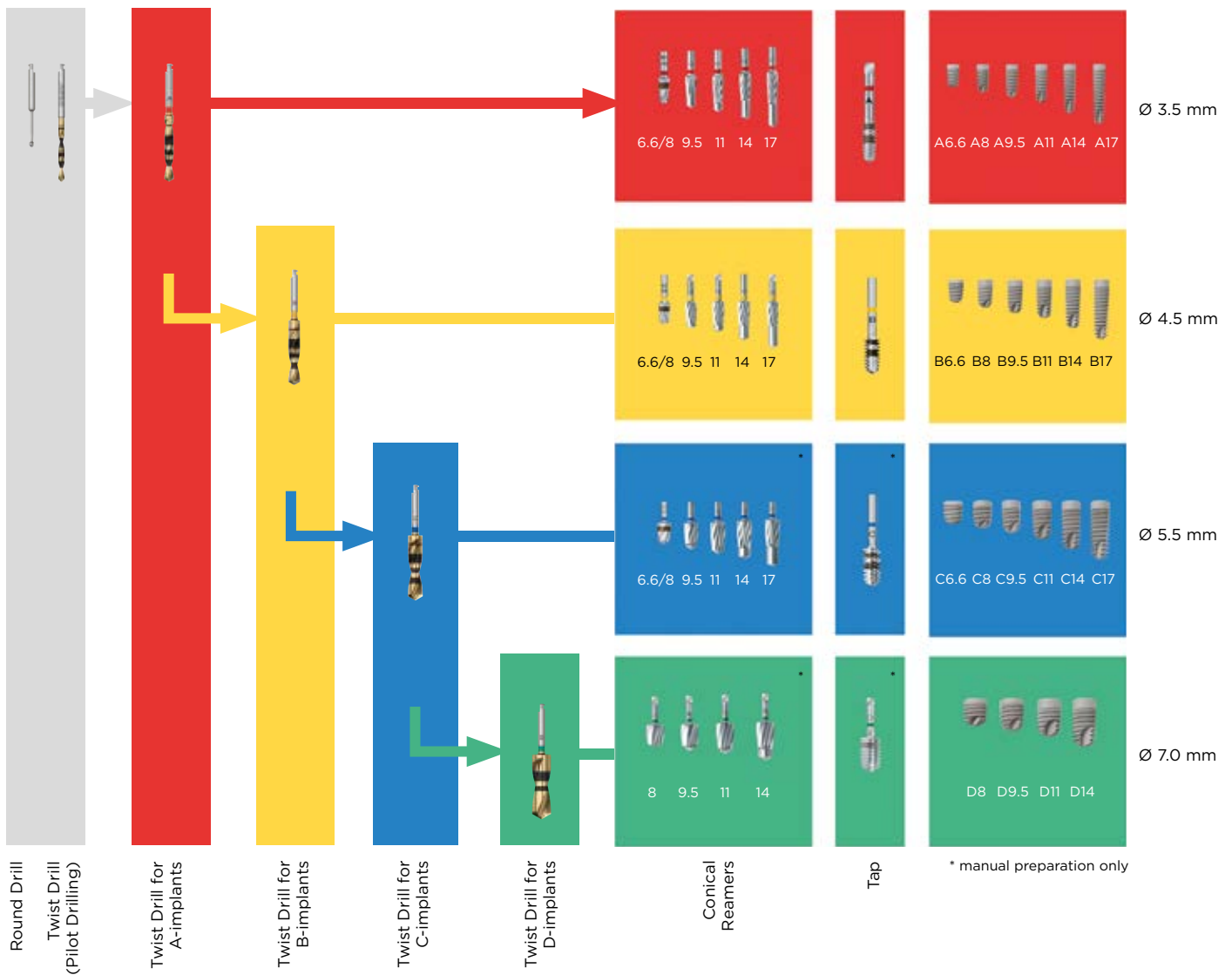

The implant site is prepared in two steps:

- Preparation until the specified implant-specific diameter has been reached (motor-driven)
- Final preparation of the implant site (motor-driven or manually)

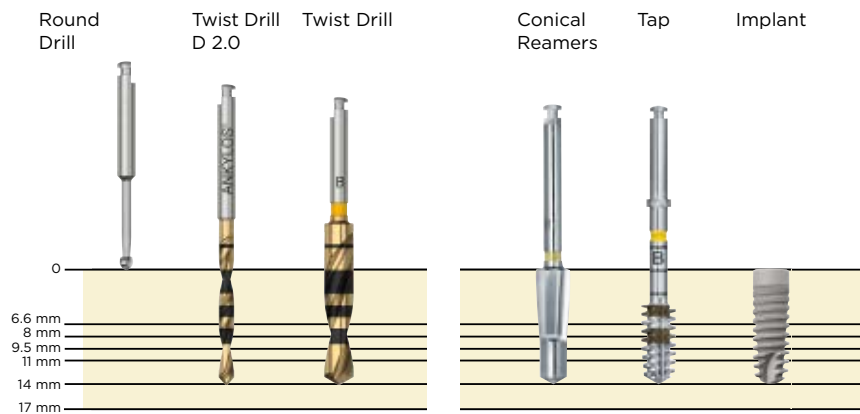

Preparation up to the implant-specific diameter

The direction and depth of the implant is specified with motor-driven instruments. The drills have ring markings to show the depth. The maximum speed of 1500 rpm must not be exceeded during this step of the preparation in order to avoid local over-heating of the bone.

The resulting bone necrosis would endanger ankylotic healing of the implant. Drilling should not be conducted in one step but intermittently under moderate pressure. Clear the drill tip from bone chips before every drilling step.

Ankylos[®] instrument set

Preparation until the specified implant-specific diameter is reached

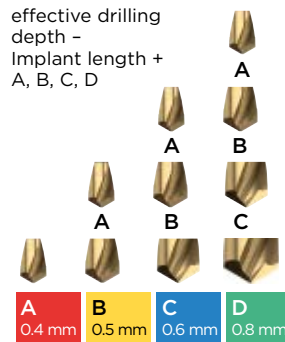
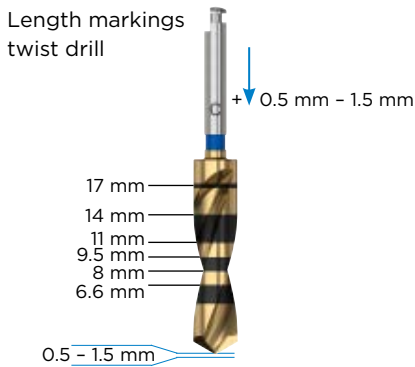

Ankylos Twist drills

For every implant diameter, twist drills in two lengths are available. The top edge of the ring markings indicates the implant lengths. The areas below the 6.6mm marking and between the 8/9.5 mm and 11/14 mm markings are shaded to improve orientation.

The effective drilling depth during preparation is slightly deeper than the specified implant length.

- Excellent cutting properties
- Laser-etched depth indication lines
- Sterile packaging
- Multiple-use* with option for single-use
- In addition to the diameter, all drills shafts are marked with a number/letter for easy identification and reference
- Color-coded

Implant sites are prepared in a step-by-step procedure using different diameter drills, instruments and verification tools, ensuring an efficient and atraumatic preparation. All drilling in the bone should be performed at a maximum of 1500 rpm using profuse external irrigation with a saline solution. An intermittent drilling technique will help prevent heating of the bone and create a pumping effect for efficient removal of bone tissue.

*All Ankylos Twist drills can be used for approximately ten cases. They should be carefully cleaned and sterilized after each surgery and replaced as soon as a decrease in their cutting efficiency is observed.

Final preparation of the implant site

The final implant site is prepared by the conical reamer and the tap. Both can be operated motor-driven using the contra-angle hand-piece or manually by ratchet inserts with the adjustable ratchet.

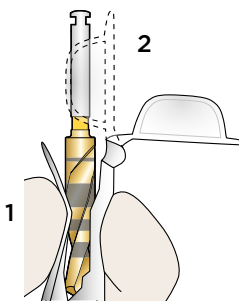

Packaging

- Open the package.
- Pour the blister onto a sterile area.
- Secure the drill by squeezing the blister.
- Expose the drill shaft by bending back the top of the blister.

Pick-up

- Engage the drill with the contra angle.

Ankylos Conical Reamer

- One reamer per implant diameter and length
- Used for conical expansion of the depth drilling in the crestal region
- Can also be used counterclockwise for bone condensation where bone density is low (manual reamers)

Ankylos Tap

- One tap per implant diameter can be used for all implant lengths
- For tapping the implant thread
- It is not necessary to tap the thread where the bone density is significantly reduced

Only manual reamers and taps are available for C- and D-implants to prevent excessively high torque.

Ankylos® instrument set

Implant driver

For implant placement, instruments for motor-driven operation with contra-angle handpieces and instruments for use with the ratchet are available.

Essential: Primary stability

During manual placement with the ratchet the surgeon can feel the increase in the resistance to screwing in the implant and thus gain information of the final primary stability of the implant. To control the torque, use the surgical ratchet with torque indication or a surgical unit with a torque measuring function.

Appropriate torque is essential for immediate function of implants. Use a maximum torque of 50 Ncm to avoid overheating of the bone or damage of the placement head.

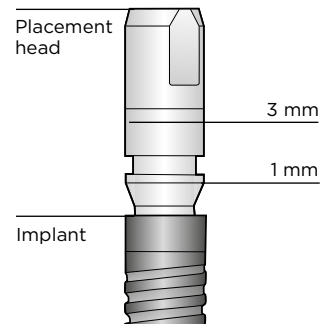

A step can be seen between implant and placement head to indicate the position of the implant shoulder.

The placement head is 3.4 mm in diameter for all implants. Even for narrow gaps, it does not need to be mounted on a different instrument. The placement head does not have a stop during insertion.



Dots are milled in a circle on the implant driver. When using the indexed abutment components in the prosthetic restoration, note that one of the markings on the implant driver indicates the vestibular direction. If this is not taken into account, problems in the alignment of angled abutments may be encountered when using the positioning aid (index). If the positioning aid will not be used, the implant depth alone must be monitored.

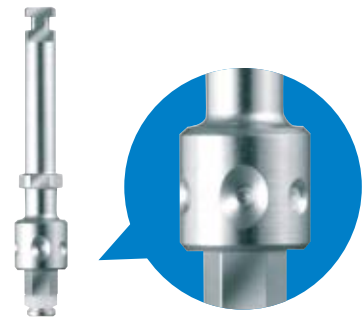
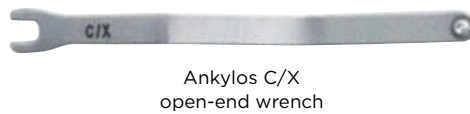
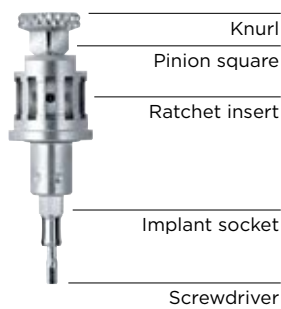

Ankylos C/X Implant Driver with Screwdriver

- Screw-retaining the implants and releasing the placement head without changing instruments
- Available in three lengths (short, medium, long) for manual implant placement

Following implant placement, the straining screw of the placement head can be loosened with the internal screwdriver. A knurl and a pinion square are located at the top end of the screwdriver. These can be used as an aid for loosening the straining screw using the C/X open-end wrench. Lateral counterlocking of the placement head is no longer required using this open-end wrench, since the ratchet insert, together with the ratchet, takes on the locking function in an axial direction.

Ankylos Implant Driver

- Two implant drivers (short and long) for contra-angle handpieces with hexagon clamping system (HXSS) and three implant drivers (short, medium, long) for manual use with handle or ratchet are available
- Circle of dots for accurate alignment of implants when using indexed prosthetic components

Step-by-step: Preparation of the implant site

Implant site preparation up to the implant-specific diameter is performed with a motor-driven set of instruments.

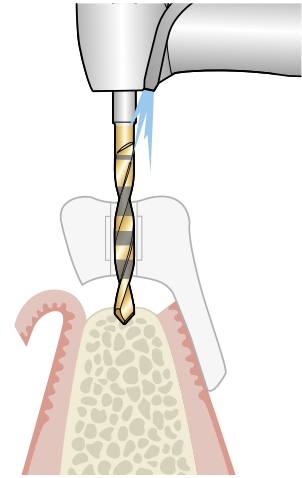
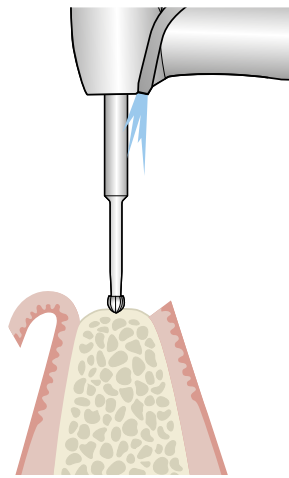
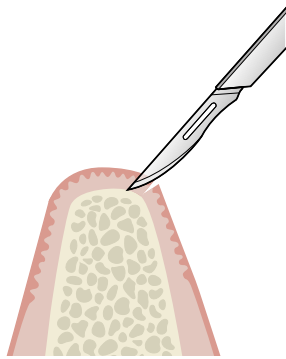

Incision

The bone is uncovered by incision. The mucosa and periosteum are mobilized and folded back. The incision direction depends on the case, and the healing mode must also be considered (transgingival or submerged).

Bone smoothing

After mobilization of the mucoperiosteal flap, sharp bone crests are slightly smoothed with the internally irrigated round drill.

The Ankylos round drills and the twist drills are operated at max. 1500 rpm (revolutions per minute).

Marking the implant position

The surgical template is positioned and the twist drill (optional: Lindemann drill) is used to transfer the implant position to the bone. The titanium sleeve for surgical guides (order no. 3104 5490) can only be used in combination with the 2 mm twist drill.

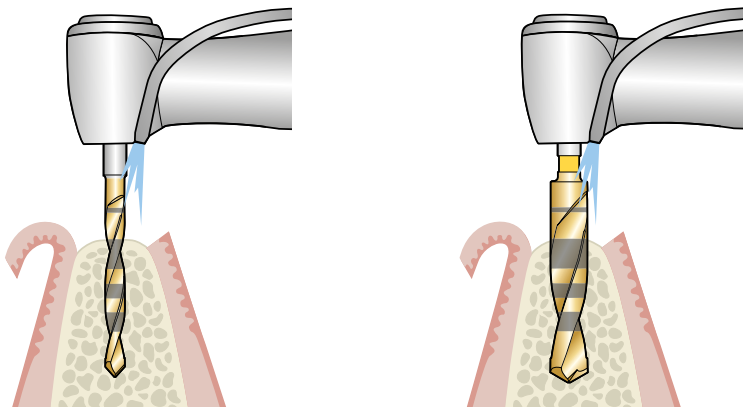

Subcrestal implant position

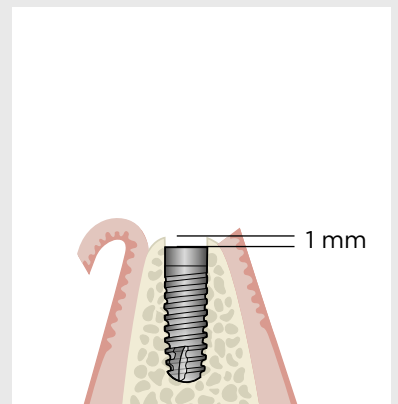

Pilot drilling with the twist drill

After removal of the surgical template the direction of the implant is defined with the twist drill. The axial alignment may deviate, within limits, from that of the surgical template depending on the ridge profile. The axial divergence can be compensated subsequently with angled abutments.

Depth drilling

Depth drilling is performed with drills. The top edge of the ring markings indicates the implant lengths. The twist drill A is always used first. When placing B, C or D-implants the cavity is expanded in ascending order of size with the B, C and D drills. An atraumatic procedure and application of low pressure where the bone density is higher is very important.

As a result of the internal tapered connection (TissueCare Concept) with sufficient vertical bone volume, the implant can be placed up to 1 mm subcrestally for improved stabilization of the peri-implant bone. This procedure allows healing without loading under the mucosa-supported denture and may improve the prosthetic result in esthetically relevant indication areas.

A planned subcrestal implant position must be considered during the pre-implant planning and when observing of the ring marks on the depth drill.

Step-by-step: Preparation of the implant site

Expanding with reamers

The depth drilling is expanded conically to fit the implant design. A separate conical reamer is available for every type of implant. They can be operated by

motor-driven with the contra-angle handpiece (A and B-implants only) or manually by the ratchet.

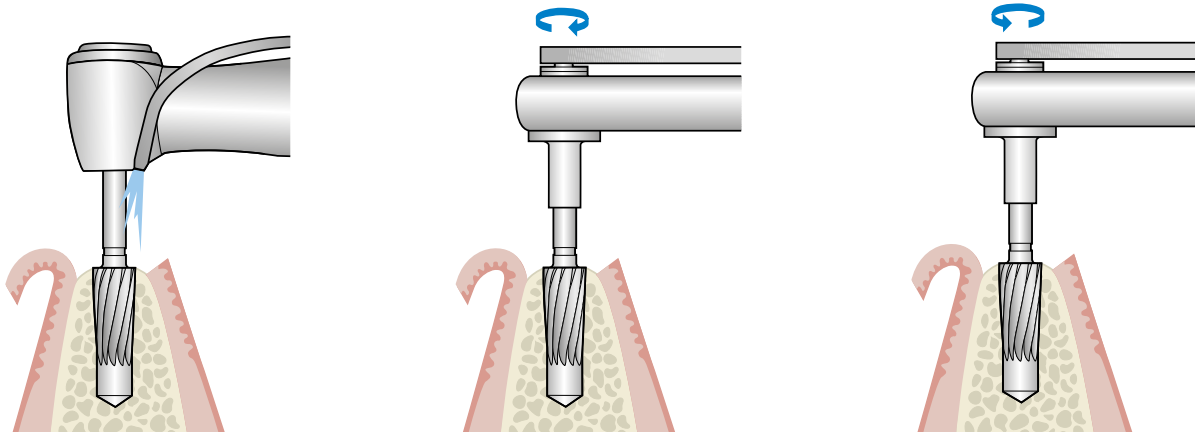

Motor-driven operation of the reamer

The reamer is inserted into a handpiece or contra-angle handpiece, if necessary a drill extension is used. The maximum speed is 15 rpm, the maximum torque 60 Ncm. The conical reamer is inserted into the drilled hole and preparation is started with clockwise rotation without high pressure. The non-cutting tip ensures that the drilled hole is not deepened. The reamer is removed from the cavity while still rotating.

When preparing for an implant of 6.6mm length observe ring marking at the reamer 6.6/8.

Manual operation of the reamer

Reamers and ratchet inserts for instruments are joined to the required length and inserted into the ratchet. The arrow on the switch button of the ratchet shows the direction of rotation. The pins on the open-end wrench assist in guiding the instrument to prevent it from tilting. The conical reamer is inserted into the cavity and preparation is started without pressure. Light pressure should only be applied for the last quarter of the preparation step. The non-cutting tip ensures that the drilled hole is not deepened. The reamer is rotated one revolution counterclockwise before removing it.

Optional: Bone condensation

With reduced bone density the conical reamer can be rotated counterclockwise to improve the bone implant site. This procedure condenses the bone structure in the wall of the cavity (this improves primary stability).

Tapping the thread

Taps are selected according to the implant diameter; they can be used for motor-driven tapping with the contra-angle handpiece (A and B-implants* only) or manually with the ratchet.

Reduced bone density

It is not necessary to tap the thread if the bone density is significantly reduced (bone class D IV). The progressive thread design of the Ankylos implant is designed for self-tapping placement.

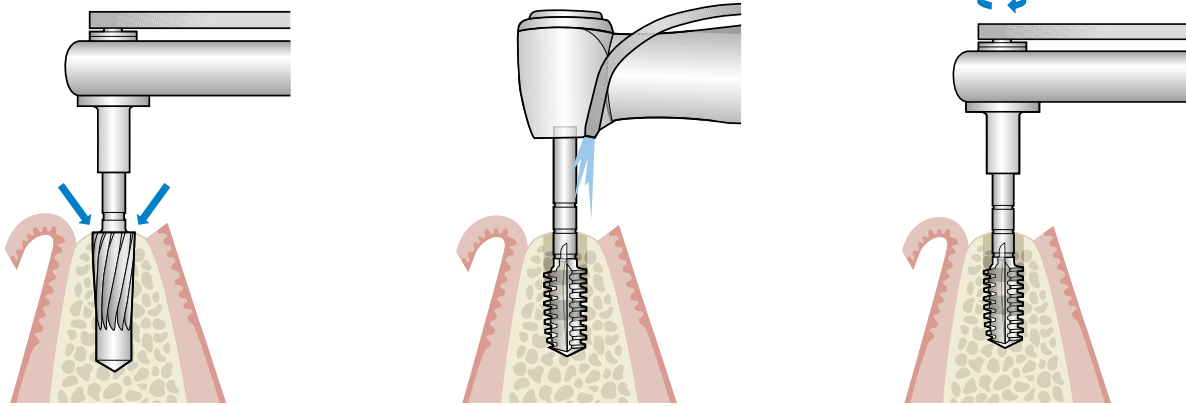

Measurement

The reamer is also used as a gauge. After expanding the cavity the top margin of the reamer, depending on the planned implant position (see option: Subcrestal implant position), must stop slightly below the bone surface.

If this is not the case, the implant site must be deepened to the required depth with the last used Twist drill. The cavity is rinsed with physiological saline solution after removal of the reamer.

Motor-driven operation of the tap

The tap is inserted into a handpiece or contra-angle handpiece, if necessary a drill extension is used. The maximum speed is 15 rpm, the maximum torque 60 Ncm.

The Ankylos thread is prepared clockwise. The depth is checked by the depth markings and the preparation is stopped at the correct depth. Otherwise the thread may be stripped and this will affect the primary stability. On completion of thread preparation the tap is screwed out of the implant site counterclockwise and the cavity is rinsed again with physiological saline solution.

If the surgical unit in use does not have adequate torque, use manual preparation.

Manual operation of the tap

A version of the tap is available for manual operation. The tap corresponding to the implant diameter is attached to the ratchet insert for instruments to the required length and inserted into the ratchet. The tap is used as previously described.

Step-by-step: Placement of Ankylos® C/X implants

Ankylos implants are designed for single use only. A previously placed or non-sterile implant must not be used. The implant must not be used after the expiry date. Do not interrupt the sterile chain under any circumstances.

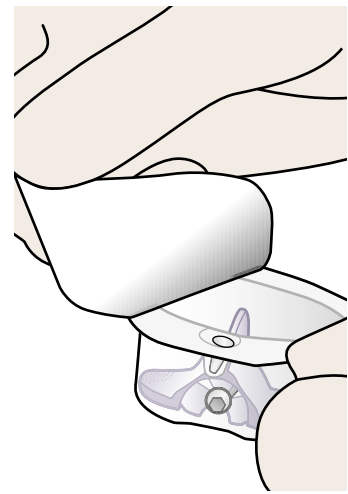
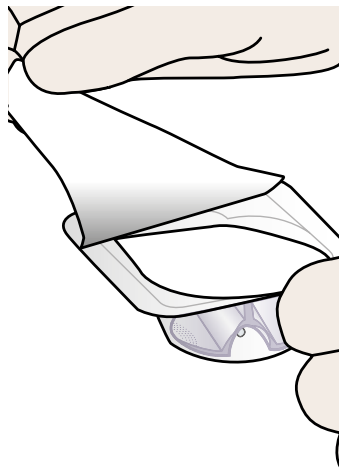
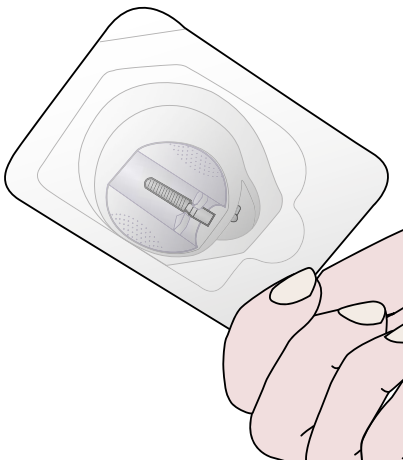

Removing the implant from the packaging

After preparation of the implant site, the implant packaging is opened outside the sterile area and the sealing foil of the outer blister is removed.

Inner blister

The inner blister is removed under sterile conditions and the sealing foil is removed in the sterile area. Peel-off adhesive labels with the batch number are on the sealing foil of the inner blister for subsequent documentation in the patient's file or the implant passport.

Keep the inner blister horizontal with the sealing foil upwards when opening and keep it after removal of the implant holder; it contains the cover screw of the implant, which is mounted after implant placement for submerged healing.

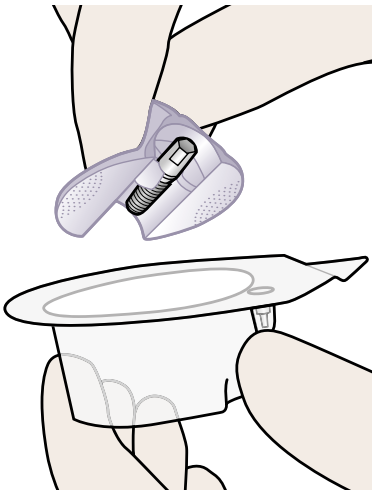

Implant holder

The implant holder, which holds the Ankylos C/X implant with the placement head, is removed. The implant holder can be safely transferred with the three wings for holding it.

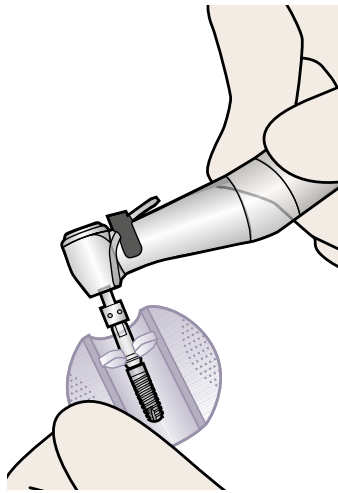

Placing the implant driver

To remove the implant, the motor-driven or manual implant driver of the required length is inserted into the internal hex of the placement head. Push the implant holder together slightly by the opposite wings to prevent the implant from rotating. Check that the instrument is firmly seated.

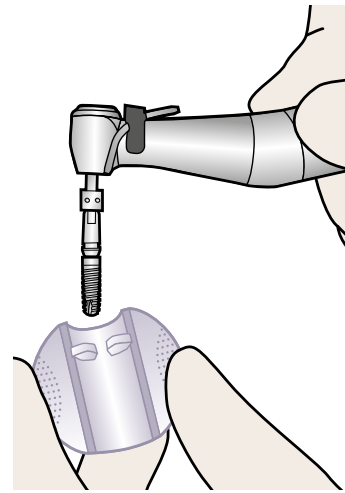

Removing the implant

The implant can be transferred to the implant driver while remaining under control at all times by slightly bending the parallel wings of the implant holder.

Step-by-step: Placement of Ankylos[®] C/X implants

To prevent heat necrosis the rotary speed when placing implants must not exceed 15 rpm.

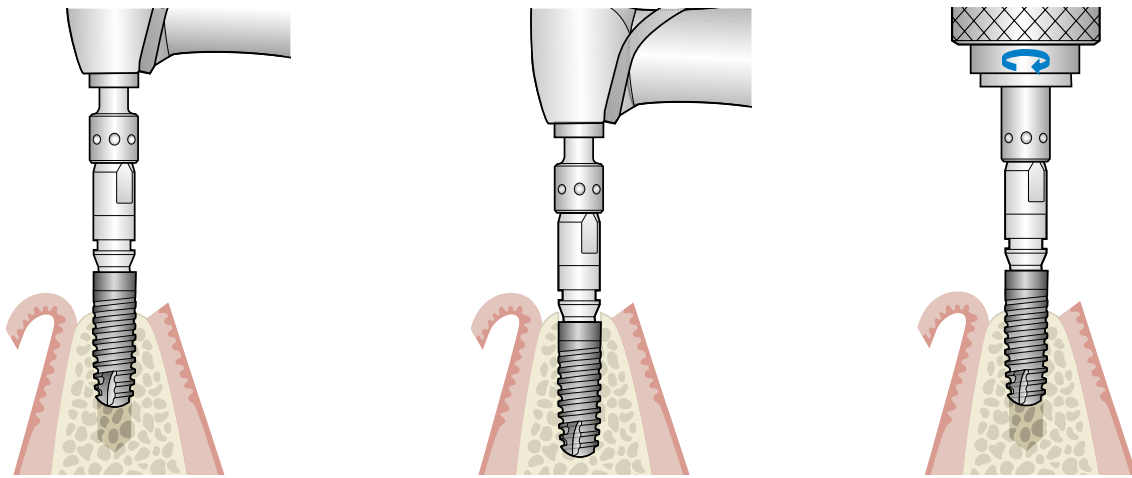

Motor-driven implant placement

After the implant has been removed from the implant holder with the implant driver (motor) fixed in the contra-angle handpiece, it is screwed into the jawbone.

The maximum speed is 15 rpm, the maximum torque 50 Ncm. Make sure that no fibrous or epithelial tissue is transferred to the implant site.

If the implant becomes difficult to screw before it reaches the final position, unscrew it and rinse or tap the implant site again.

For the use of indexed abutment components in the prosthetic restoration, note that one of the markings on the implant driver indicates the vestibular direction.

Placing the implant manually

The handle for ratchet insert is attached to the implant driver of the desired length in order to remove the implant from the implant holder. The implant is screwed into the jawbone for about two thirds of its length. Make sure that no fibrous or epithelial tissue is transferred to the implant site.

If the implant becomes difficult to screw before it reaches the final position, unscrew it and rinse or tap the implant site again.

Removing the placement head

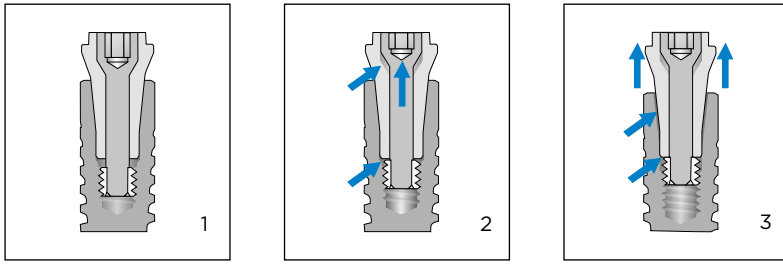

1 | Placement head pre-mounted in the implant, retaining screw tightened.

2 | Retaining screw loosened from implant.

3 | Retaining screw pushes the placement head out of the implant.

Make sure that the surface of the taper connection is clean prior to the installation of the cover screw, gingiva former or abutment.

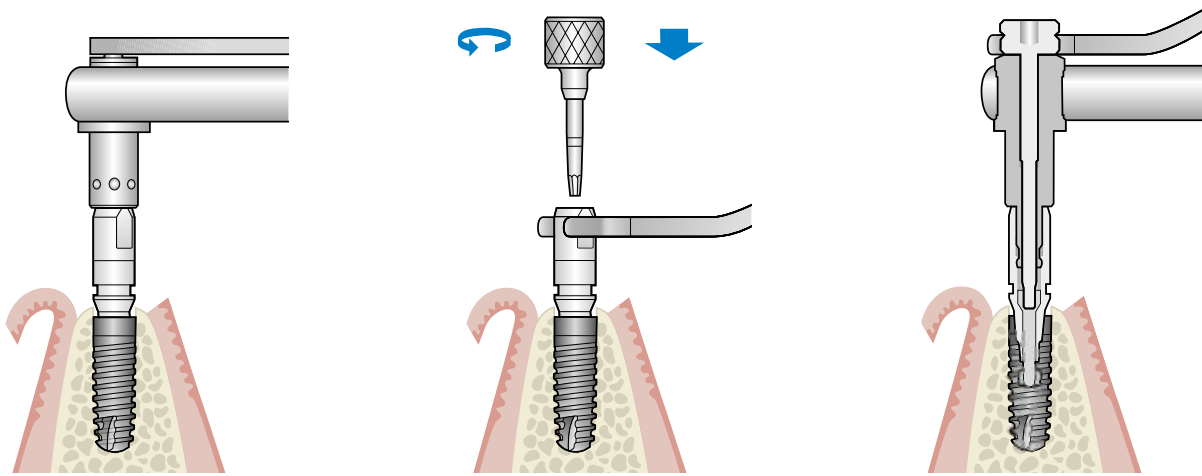

Final positioning with ratchet

For the use of indexed abutment components in the prosthetic restoration, note that one of the markings on the implant driver indicates the vestibular direction. If this positioning aid will not be used, the implant depth alone must be monitored.

Disassembly of implant driver and placement head

When the implant has reached its final position, check that it is tightly seated, then the implant driver is removed from the placement head (fig. 1). Then hold the placement head with an open-end wrench, straining the clamping screw of the placement head with the 1 mm hex screwdriver with one turn (fig. 2). With a second turn of the screwdriver, the straining screw pushes the placement head out of the implant (fig. 3). Remove the placement head from the oral cavity. When doing so, make sure that the placement head cannot be swallowed or inhaled. In soft bone the placement head must be locked with the C/X open-end wrench to prevent rotation.

Alternately: C/X implant driver with integrated screwdriver

The implant can also be seated and screwed in via the placement head with this instrument as described previously. After reaching the final implant position, the screwdriver integrated into the implant driver is used counterclockwise, with the C/X open-end wrench to release the straining screw of the placement head. Then the C/X implant driver is removed from the patient's mouth using the placement head and ratchet.

Simplant[®] SAFE Guides – Ankylos[®]

A custom-made Simplant SAFE Guide is fabricated from the patient's digital planning data using the stereolithography technique. This guarantees the exact and precise transfer of the planning into the patient's mouth.

The unique lateral drill guide access enables an extremely convenient course of treatment, even where space is limited. Only one Simplant SAFE Guide per patient and jaw is required to guide all of the drills.

Three types of drill guides are available for computer-guided implant surgery with Simplant:

Bone-supported guide

for optimal, undistorted guide seating. Ideal in combination with augmentation.

Mucosa-supported guide

for minimally invasive procedures (flapless surgery) for edentulous patients and where there is minimal remaining dentition.

Tooth-supported guide

for partially edentulous patients with few missing teeth.

Lateral access

Along with the closed sleeve, as an alternative, a Simplant SAFE Guide sleeve with lateral access can also be selected for each implant, with lingual or buccal opening option.

The lateral drill guide access provides additional convenience: it reduces the insertion height of the drill by at least 4 mm, but up to 10 mm, depending on the implant position and the thickness of the mucosa. Thus, effortless guided surgery is facilitated in the posterior region and where there is limited space.



Ankylos® GS (Guided Surgery) instrument set

Specific instruments are available for computer-guided implant placement of Ankylos C/X A- and B-implants with Simplant. These are marked “GS” (Guided Surgery) and can only be used together with the Simplant SAFE Guide.



Ankylos Rotary Tissue Punch GS

The punch is used to make a minimally invasive circular incision in the planned implant position and corresponding to the implant diameter.

The Tissue Punch is used without the drill sleeve, directly in the drill guide.

- Laser-marked implant diameter identification
- Color-coding for respective implant diameter
- Internal irrigation
- Guided directly in the guide, using the guide sleeve
- Recommended speed: 800 rpm

Ankylos Initial Drill GS

After using the rotary tissue punch, the mucosa and the bone coronal to the implant shoulder is removed with the initial drill. The bone is “center-punched” as a centering aid for the subsequent twist or Tri-Spade drill. The initial drill is guided directly in the guide.

- Laser-marked implant diameter identification
- Color-coding for respective implant diameter
- Internal irrigation
- Helicoidal chip space for optimal removal of drilling chips
- Guided directly in the guide
- Recommended speed: 800 rpm

Following the incision of the mucosa with the GS rotary tissue punch and center-punching the jawbone using the GS initial drill, the implant site is atraumatically and precisely prepared using the Ankylos Sleeve-on-Drill drills until the intended implant diameter has been reached.

Ankylos[®] GS (Guided Surgery) instrument set

Sleeve-on-Drill™ drill system

Drills specially developed by Dentsply Sirona Implants with a sleeve that can be fixed directly to the instrument ensure

simple and precise guiding of the drill using the guide. The drill stop system ensures exact depth control.



Ankylos twist and Tri-Spade drills GS

The twist/Tri-Spade drills have different diameters and are used to prepare the implant site step by step until the planned implant diameter is reached. The twist drill GS D 2.0 is used for the pilot drilling. Tri-Spade drills GS A and B are used to expand the implant site until the planned implant diameter is reached. Twist and Tri-Spade drills are available in the implant lengths and are used according to the length of the planned implant.

All twist or Tri-Spade drills are used with the Sleeve-on-Drill system and are equipped with a mechanical depth stop. This ensures that the planned drilling depth is not exceeded and that all drilling diameters reach the same drilling depth.

- Laser-marked implant diameter and length identification
- Color-coding for respective implant diameter
- Internal irrigation
- Guided with the Sleeve-on-Drill system
- Recommended speed: 800 rpm

L 8 or L 9.5 drills are initially used to drill the hole for L 11 and L 14 length implants in order to ensure the correct alignment of the Sleeve-on-Drill drill sleeve on the L 11 or L 14 drill.

Sleeve-on-Drill™ drilling sleeves

The Sleeve-on-Drill sleeves ensure that the drill is accurately guided in the drill guide.

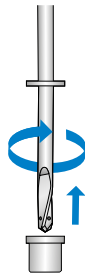

Ankylos sleeves for GS drill

Prior to commencing the operation, the Sleeve-on-Drill drilling sleeves are pushed over the drill tip by turning the drill gently against the direction of rotation and are held in the fixing groove. No instruments are required for this.

To prepare the implant site, the drilling sleeves are introduced into the guide sleeve along with the drill and are removed again following the drilling.

- Narrow sleeve (ND) for A implants
- Wide sleeve (WD) for B implants
- Disposable articles; sterilize before use
- Not included in the Ankylos GS surgical kit – please order separately for each case in the 10 pack or set

All drilling sleeves are non-sterile on delivery and must be cleaned and sterilized prior to use in accordance with the information in the instructions for use. The drilling sleeves are single patient articles and must be removed from the drill immediately after use.



Ankylos[®] GS (Guided Surgery) instrument set

The final implant site for the Ankylos C/X implants is prepared using the conical reamer and the tap. The Ankylos instrument set can only be used with the contra-angle handpiece.

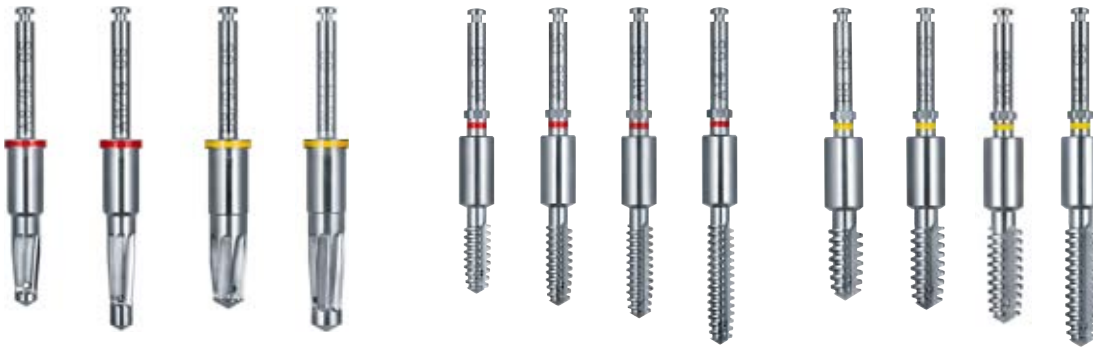

Ankylos Conical Reamer GS

The conical reamer is used to expand the depth drilling in the crestal region conically in accordance with the implant design. Two conical reamers are available for each implant diameter: one instrument for the 8 and 9.5 mm implant lengths and one for the 11 and 14 mm implant lengths.

- Laser-marked diameter and length identification and color-coding ring for the respective diameter
- Internal irrigation
- Guided directly using the guide sleeve
- Mechanical depth stop
- Recommended speed: 15 rpm at 50 Ncm max.

Ankylos Tap GS

The Ankylos tap GS is used for pre-cutting the implant thread over the entire length of the implant. Pre-cutting the thread or not tapping the entire length can only be dispensed with where there is severely reduced bone density (bone class D IV). A tap is available for each implant diameter and length.

- Laser-marked diameter and length identification and color-coding ring for the respective diameter
- Internal irrigation
- Guided directly using the guide sleeve
- No mechanical depth stop
- Recommended speed: 15 rpm

Implant drivers

The Ankylos C/X implants are inserted via the placement head. GS implant drivers for template-guided implant placement are available for this. Where multiple implant sites are prepared, the

Implant SAFE Guide is secured against lateral displacement and twisting with the aid of stabilization abutments introduced into the placement heads.



Ankylos Implant Driver GS

The implant is inserted to the planned insertion depth when the top of the guided part of the implant driver GS is flush with the tube of the guide. Instead of a mechanical depth stop, the implant driver has an optical depth stop. That avoids any tilting or bending of the guide as well as the risk to damage the osteotomy. The implant driver should preferably be used with a torque-controlled contra-angle handpiece; alternately with a corresponding ratchet ideally with a torque indicator.

The use of a guide can influence the measurement of the torque with the ratchet.

- Hex on the ISO shaft for use with Frios contra-angle handpieces with hexagon clamping system for better transfer of the torque (compatible with all common contra-angle handpieces)
- Hole in the shaft to align the abutment position and to monitor the rotational speed
- Guide sleeve is detachable and is screwed on the implant driver; replacement sleeves available
- Narrow diameter for C/X A-implants and wide for C/X B-implants
- Each in long and short variants
- Torque to be achieved: ≤ 50 Ncm
- The implant driver is demountable for cleaning

Ankylos Stabilization Abutment GS

The stabilization abutment secures the drill guide additionally against lateral displacement and twisting where multiple implant sites are prepared. For this purpose, the first implant site must be thoroughly prepared, the implant placed and provided with a stabilization abutment. Then, the second implant site, preferably in the opposite quadrant, is also prepared and treated. All other implant sites can only be prepared simultaneously if the drill guide is fixed with no fewer than two stabilization abutments.

The use of stabilization abutments is absolutely required for the first two implants, but is optional for all further implants.

Step-by-step: Insertion of the Simplant® SAFE Guide – Ankylos®

The Simplant SAFE Guide should be inserted and firmly attached prior to commencing the implant site preparation. The procedure will vary depending on the type of drill guide used.



Photographs: Dr. Dhom and Partners Practice, Ludwigshafen, Germany

Prior to inserting the guide

Sterilize the drill guide according to the Simplant Instructions for use.

Provide all of the drills to be used with Sleeve-on-Drill drilling sleeves and check their fit in the guide sleeves.

Check the correct fit and the correct fabrication of the Simplant SAFE Guide.

If there is any doubt, checking the drilling depth initially using conventional methods and not relying on the mechanical depth stop is recommended.

Organize all the required instruments in the surgical kit in order of use.

All components intended for multiple use must be sterilized in accordance with the information in the instructions for use.

Bone-supported Simplant® SAFE Guide

A bone-supported drill guide is used for edentulous and partially edentulous patients with more than three missing teeth.

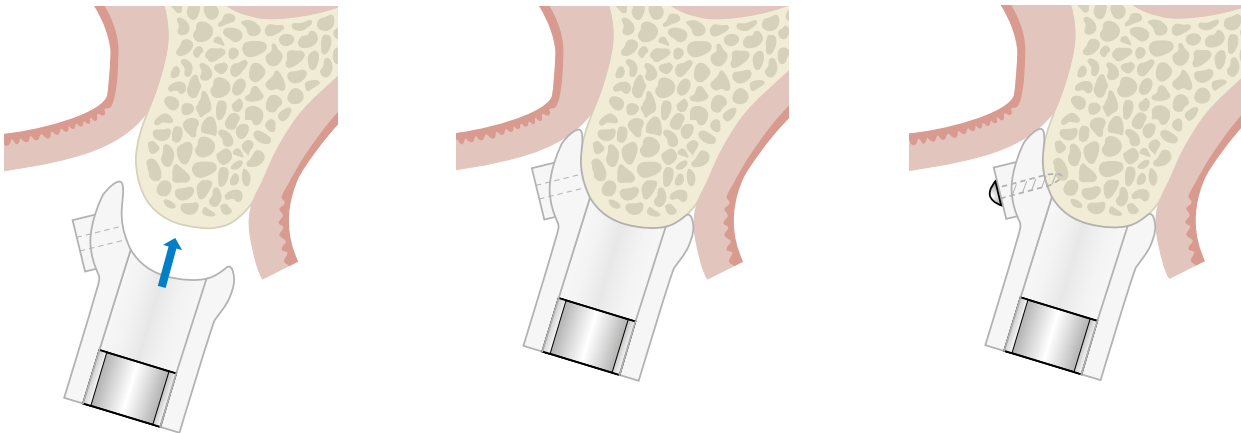

Bone-supported Simplant SAFE Guide

First of all, check the coverage of the guide base. This should only be as large as necessary, in order to guarantee a definite and stable fit. If necessary, grind the base without affecting the stability of the guide or the fixation of the guide sleeves.

When using a bone-supported Simplant SAFE Guide, an incision is made into the alveolar ridge. In the process, the bone should only be uncovered as far as is absolutely necessary to be able to position the guide correctly.

Then, the Simplant SAFE Guide is inserted into the patient's mouth and checked for a precise and stable fit. Then attach the guide as required in the designated positions in the jaw.

Check the position, the fit and the stability prior to inserting the Simplant SAFE Guide. The guide may only be used if the correct position and an exact fit in the patient's mouth are ensured. Excessive force on the drill guide should be avoided: only use fixation screws with guide sleeves and do not over-tighten the fixation screws. Avoid tilting and excessive pressure from the Guided Surgery instruments. Excessive forces on the guide, particularly on the fixation points and the guide sleeves, may result in breaking the guide sleeves or fracturing the guide and rendering these unusable.

Step-by-step: Insertion of the Siplant[®] SAFE Guide – Ankylos[®]

Mucosa-supported Siplant[®] SAFE Guide

Mucosa-supported drill guides guarantee a minimally invasive procedure and are generally utilized for edentulous patients.

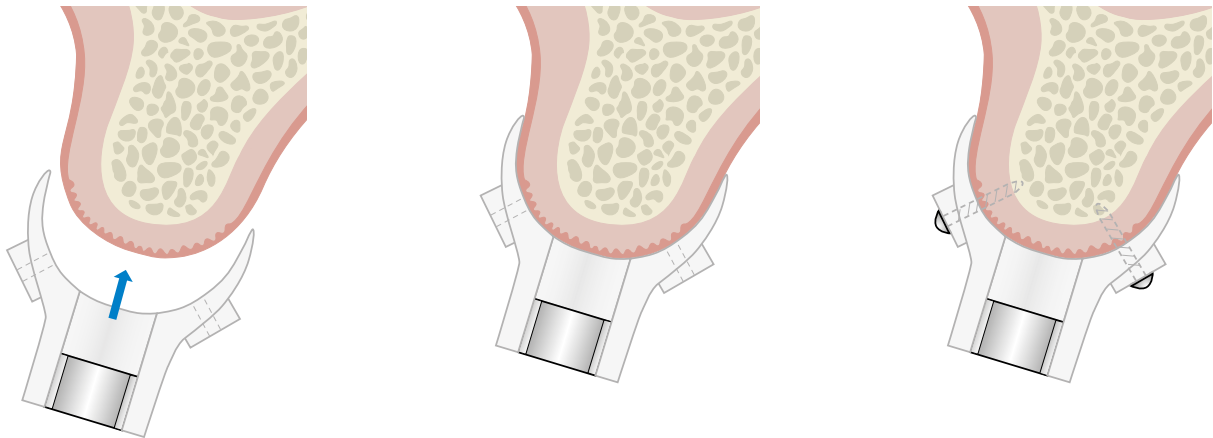

Mucosa-supported Siplant SAFE Guide

Check the fitting of the guide on the plaster model. This must be large enough to ensure a stable fit. Ideally, the coverage is identical with the scanning template. If the base goes beyond motile structures such as reflections, the floor of the mouth, the labial frenulum or the Aline, grind this as much as necessary without affecting the stability or the fixation of the guide sleeves.

The Siplant SAFE Guide is inserted into the patient's mouth and checked for a precise and stable fit.

A check bite made from plastic or registration silicone, fabricated beforehand in the articulator, guarantees that the guide records the same position as the scanning template.

Carefully close the patient's mouth and allow him to bite into the registration material. The Siplant SAFE Guide is first fixed vestibularly in the designated positions in the jaw. Then, remove the check bite and now, if required, use designated fixation devices also palatally or lingually.

When placing multiple implants, mucosa-supported Siplant SAFE Guides must also be stabilized with stabilization abutments. At least the first two implants must be prepared, inserted and provided with a stabilization abutment before drilling is carried out at other sites. Hence, the guide cannot be displaced or distorted between the further drilling processes.

Tooth-supported Siplant® SAFE Guide

A tooth-supported guide can be combined using the flapless technique or by folding back the gingiva.

These drillguides are used for partially edentulous patients or for single gaps.

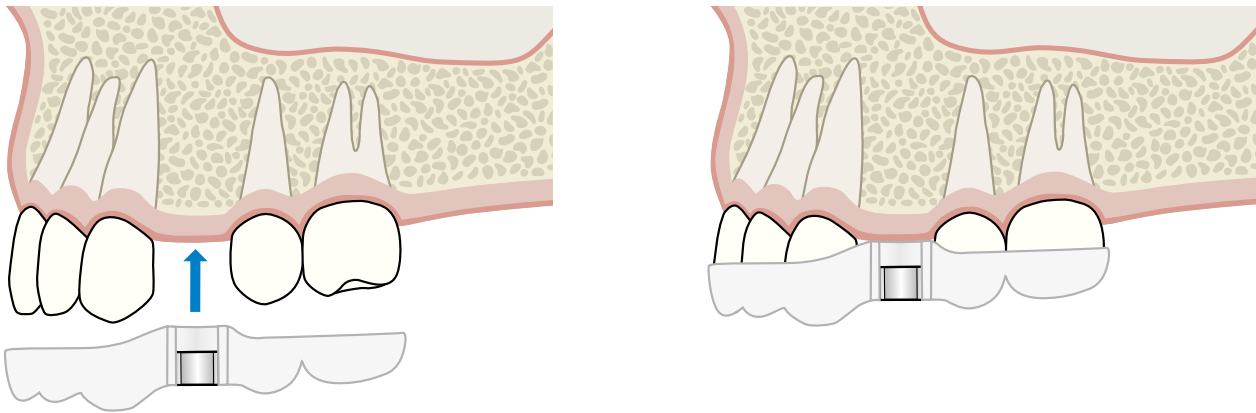

Tooth-supported Siplant SAFE Guide

Check the coverage of the guide base and adjust it if necessary. Here, depending on the design of the template, the criteria for bone- or mucosa-supported guides apply to the edentulous regions (see page 39 and 40).

The Siplant SAFE Guide is inserted into the patient's mouth and checked for a precise and stable fit. Small openings along the cutting edges and/or the tips of the cusps of the teeth will make checking easier.

Where there is little remaining dentition or an unstable fitting, the guide is affixed analogously to the procedure for bone- or mucosa-supported guides.

Where there is little remaining dentition or where there is a statically unfavorable structure of the existing teeth, tooth-supported Siplant SAFE Guides must also be stabilized with stabilization abutments when placing multiple implants. In this case, at least the first two implants must be prepared, inserted and provided with a stabilization abutment before drilling is carried out at other sites.

Step-by-step: Preparation of the implant site

The implant site is prepared for the purposes of Guided Surgery using the same steps as for conventional preparation. In the following, the transgingival procedure with mucosa-supported guide is described by way of example. The Rotary Tissue Punch is only required for flapless surgery.

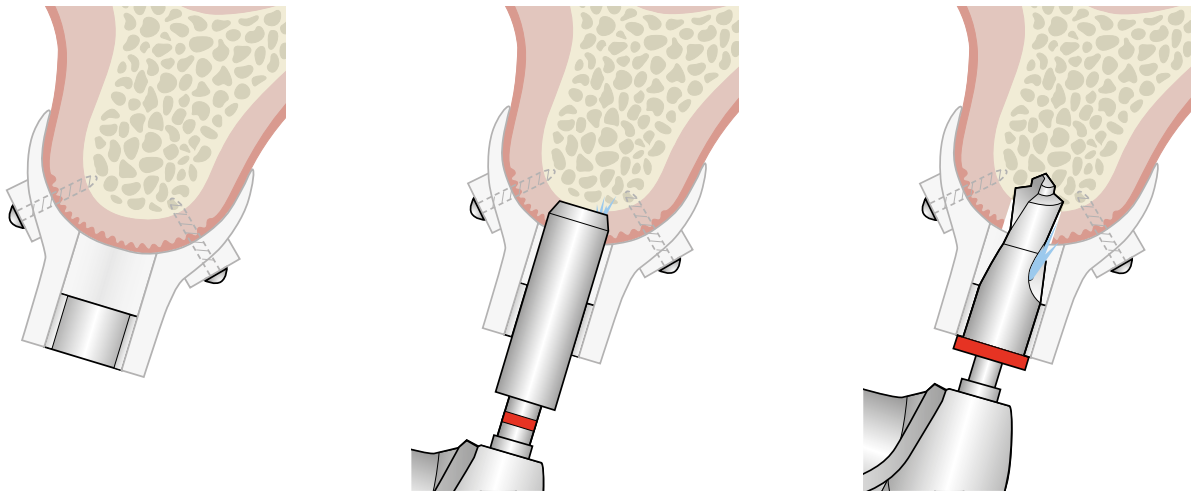

Implants should be inserted in succession: prepare the first implant site, insert the implant, attach the drill guide with stabilization abutment. Then prepare the second implant site, etc. The second implant may only be prepared in any case if the drill guide has been attached after the insertion of the first implant.

Mucosa punching

Connect the internal cooling without the Y adapter for the external cooling and check the flow prior to commencing preparation.

A minimally invasive circular incision of the planned implant diameter is made to the coronal bone margin using the Ankylos Rotary Tissue Punch GS.

Initial drilling

Using the Ankylos initial drill GS, the mucosa and the coronal bone up to the implant shoulder are removed and center-punched. The pilot drill is guided directly in the guide sleeve.

Be mindful of sufficient internal instrument irrigation during the preparation. The opening for the internal irrigation can be obstructed by bone chips during the preparation. Hence, particularly where multiple cavities are prepared in succession, checking the uninhibited coolant flow outside of the guide regularly and, if required, clearing the opening using the drill cleaning instrument are recommended.

Where the instruments become damaged or blunt, replace these; replace the instruments, however, after not more than 20 uses. Only use the twist drill with a suitable drilling sleeve. Use each drilling sleeve for a maximum of 10 drilling procedures on the same patient. Dispose of all used drilling sleeves immediately after completing the procedure, as the sleeves may later be difficult or not possible to remove from the drill due to adhesion.

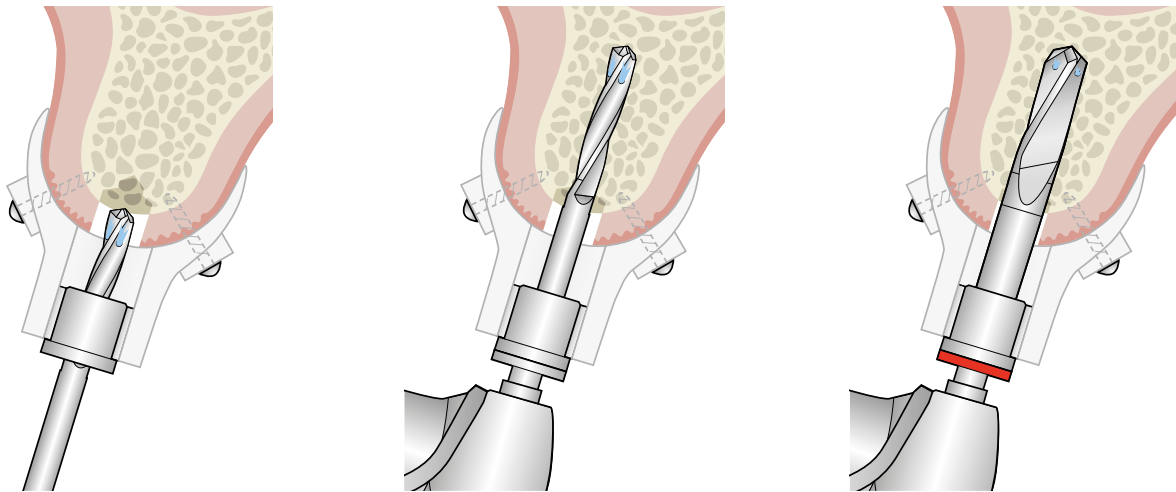

Pilot drilling

The stationary 2 mm GS twist drill of the planned implant length is introduced into the patient's mouth.

For this process, the Sleeve-on-Drill sleeve is locked into place in the first groove above the drill tip. Then lower the drilling sleeve into the guide sleeve of the drill guide to the stop. Do not activate the rotation until this point.

Drill rapidly but without excessive pressure to the drill stop. The still rotating drill is only withdrawn to the original position after reaching the desired depth (no intermittent drilling). Stop drilling after reaching the depth position stop.

Carefully move the stationary drill back and forth, gently pulling, until the Sleeve-on-Drill sleeve on the drill is released from the guide sleeve. Both are then removed together from the patient's mouth. If the drilling sleeve in the Simplant SAFE Guide becomes stuck, remove this using pliers or tweezers.

L 8 or L 9.5 drills are initially used to drill the hole for L 11 and L 14 length implants in order to ensure the correct alignment of the Sleeve-on-Drill drill sleeve on the L 11 or L 14 drill.

Expansion drilling

After the pilot drilling, the implant site is prepared to the planned implant diameter using Ankylos GS A and, if required, B Tri-Spade drills in ascending order.

The Tri-Spade drills are used according to the length of the planned implant. This means that the shortest possible instrument is always available where space is restricted.

Step-by-step: Preparation of the implant site

After reaching the intended implant diameter, the drill hole is reamed out conically in accordance with the Ankylos implant design. For the purposes of Guided Surgery, two conical reamers are available for each implant diameter:

one for the shorter implant lengths, 8 and 9.5 mm, and one for the 11 and 14 mm lengths. Subsequently, as a rule, the implant thread is then pre-cut. Tapping can only be dispensed with where there is severely reduced bone density (D IV).

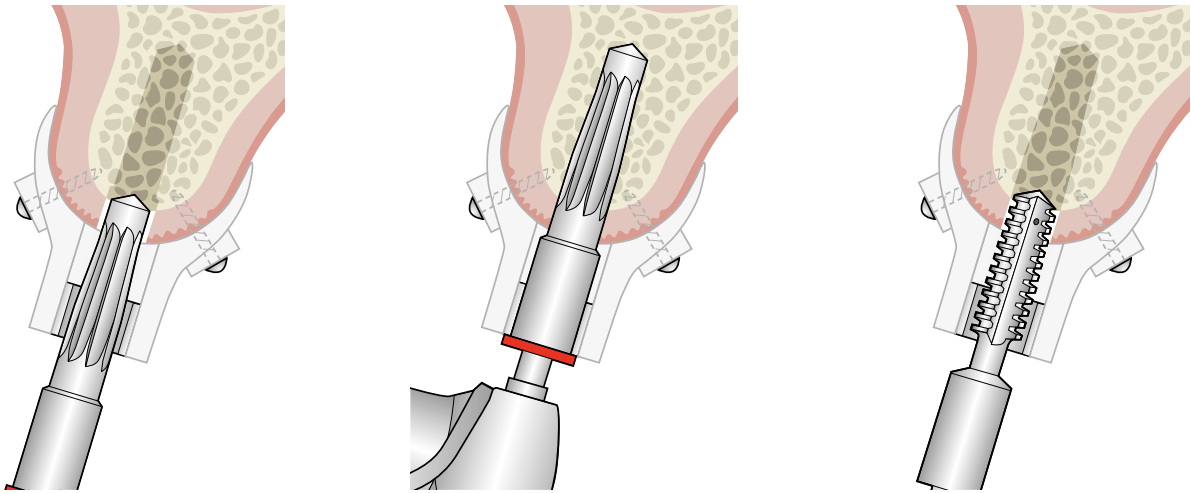

Crestal bone preparation

The crestal region of the implant site is prepared using the conical reamer. The reamer suitable for the planned implant is inserted into the contra-angle hand-piece. If required, a drill extension can be used. The maximum rotary speed is 15 rpm; the torque is a maximum of 50 Ncm.

The conical reamer is guided into the drill hole by the drill guide and the preparation is commenced in a clockwise direction, under a slight pressure.

When the drilling sleeve has reached the stop on the reamer, the required preparation depth has been reached. Now, withdraw the still rotating reamer from the cavity and then stop the rotation.

Tapping

The suitable diameter and length tap is inserted into the contra-angle hand-piece. The maximum rotary speed is 15 rpm; the torque is a maximum of 50 Ncm.

The Ankylos thread is prepared in a clockwise direction along the entire length of the implant. Here, the tap, with its cylindrical shaft, is guided in the guide sleeve. Unlike the reamers previously used, the tap

Since the tap does not have a mechanical depth stop, the visual control of the maximum preparation depth must be observed in any case. If the tap is screwed in too deeply, there is the risk of damaging anatomical structures and nerves.

Step-by-step: Placement of Ankylos[®] C/X implants

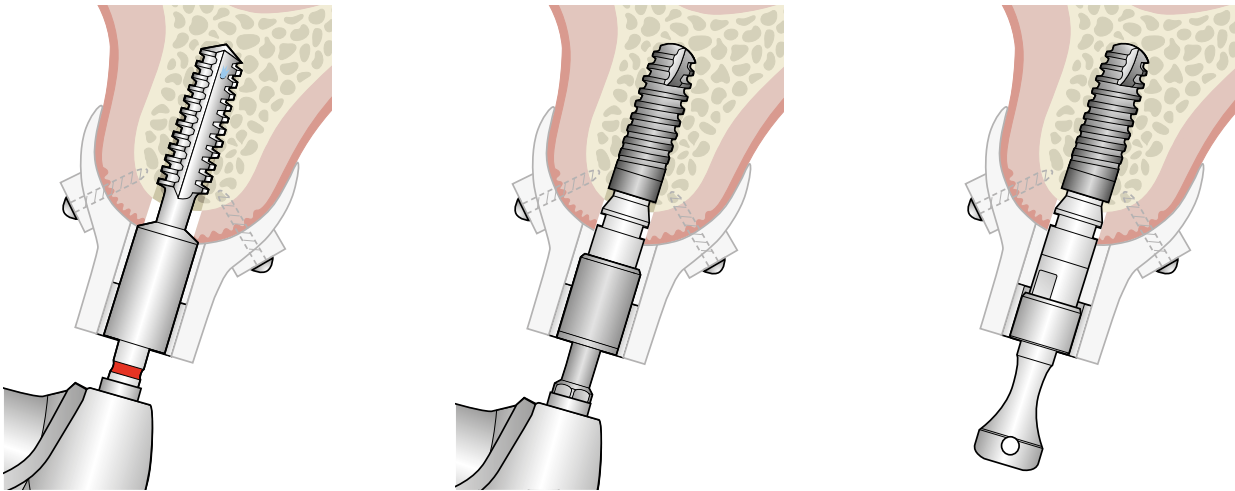

Placing the implant

is not previously used, the tap is not equipped with a mechanical depth stop. Once the guide shaft is flush with the top margin of the guide sleeve, the maximum preparation depth has been reached. Remove the tap from the cavity in a counterclockwise direction. Then flush the cavity with normal saline solution.

The Ankylos C/X implants are inserted at 15 rpm and a maximum of 50 Ncm via the placement heads screwed into the implants. The Ankylos C/X implant is inserted to the planned insertion depth with the aid of the Ankylos implant driver GS. Once the cylindrical part of the implant driver is flush with the top margin of the guide sleeve, the planned implant position has been reached.

Securing the drill guide

Prior to inserting further implants, the guide is secured against horizontal shifting using the stabilization abutment for the placement head.

At least the first two implants must be prepared, placed and provided with a stabilization abutment in succession before further implants are placed.

If the implant is screwed in deeper than planned; there is the risk of damaging anatomical structures.

Further treatment

Further treatment of Ankylos[®] C/X implants

Ankylos C/X implants allow use of both indexed or non-indexed prosthetics. An Ankylos C/X implant can be distinguished from the previous Ankylos plus implant by the lack of the four grooves on the implant shoulder.

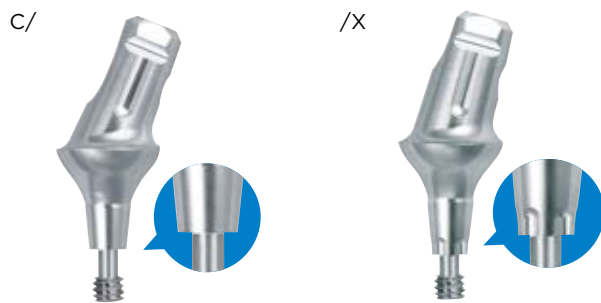

All prosthetic components for Ankylos C/X implants are laser-marked to indicate their use:

- Components marked with “C/ “ use only the “C”one for the connection and are not indexed. This means that the abutment components can be positioned as desired and are completely locked by the cone to prevent rotation.
- Components marked with “/X“ are indexed. The index is used to position the abutment components in one of six possible positions. In this case also the cone guarantees optimum stability and rotation locking.
- Components with the C/X mark are used for indexed or non-indexed prosthetics.

Ankylos C/X implants must only be used with components that are laser-marked with "C/X" "C/" or "/X", or that belong to the following product groups. Ankylos Balance Anterior and Posterior abutments and repositioning posts, Ankylos Cercon Balance, temporary abutments Balance, sulcus formers Balance Anterior and SynCone abutments.

Correction of the implant position

If it is necessary to correct the vertical implant position after disassembly of the placement head, the placement head must be mounted again. Replace it in the implant, find the orientation of the positioning aid, click it into position, and then hand-tighten the straining screw of the placement head (max. 15 Ncm). Then reposition the implant driver (manual or motor-driven) and correct the vertical implant position.

To use the indexed abutment components in the prosthetic restoration, note that one of the markings on the implant driver indicates the vestibular direction.

Step-by-step: Transgingival healing

With transgingival healing of the implants, a second surgical procedure is not necessary. At the same time, you take optimal advantage of the regeneration potential of the soft tissue for creating a perfect emergence profile. The implant is closed with a gingiva former for transgingival healing. The geometry of the

subsequent prosthetic restoration can be taken into account even when selecting the diameter. Because the gingiva former is a separate component from the implant, an abutment with a different emergence profile can be selected if the gingival margin changes during the healing phase to retain the esthetics.

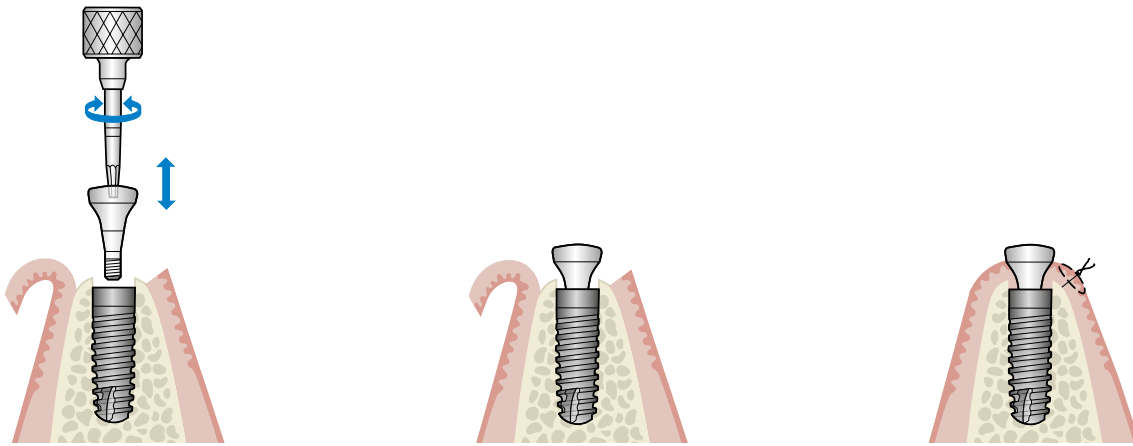

Screwing in the gingiva former

If transgingival healing is planned for the implant, a gingiva former of the same thickness as the soft tissue must be placed after removal of the placement head.

Hand-tighten the gingiva former with the 1 mm hexagon screwdriver.

Suturing

The edges of the wound are shaped to the gingiva former and fixed by a vertical mattress suture.

- Gingiva formers are supplied non-sterile and must be sterilized before use.
- Make sure that the surface of the taper connection is clean prior to the installation of the cover screw, gingiva former or abutment.
- For a temporary restoration with a partial or full denture make sure that there is no contact between the gingiva former and the temporary denture.

Step-by-step: Submerged healing

The implant healing phase is generally three to four months regardless of the location in the maxilla and mandible. One exception is augmentation procedures conducted simultaneously; the healing phase must be extended for a single-stage procedure.

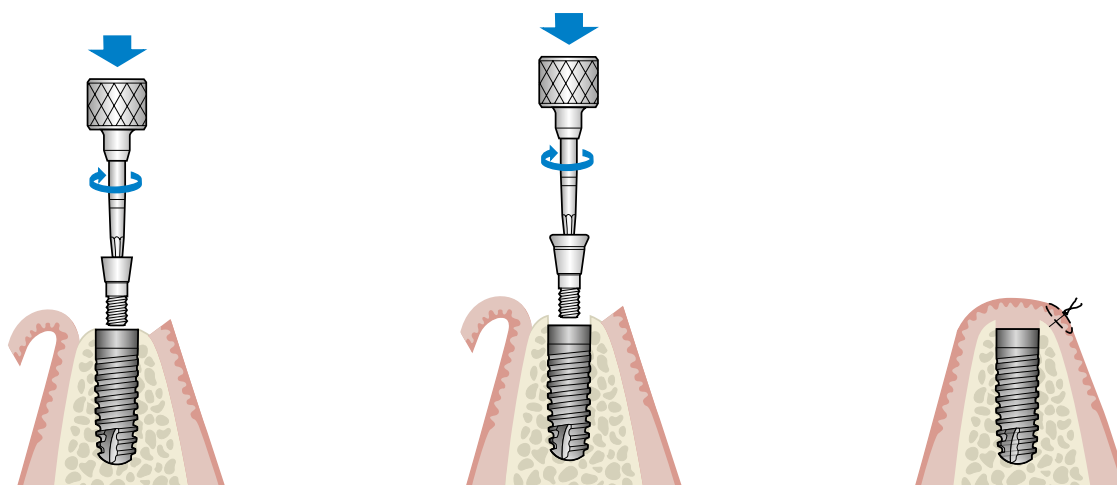

Placing cover screw when implant is in crestal position

If the implant is planned for submerged healing, the cover screw must be placed after removal of the placement head. Remove the cover screw from the inner blister with the 1 mm hex screwdriver and screw it hand-tight into the implant with approx. 6 Ncm.

The cover screw delivered with the implant flushes with the implant shoulder.

Placing cover screw when implant is in subcrestal position

When the implant is placed subcrestally the cover screw 1 mm is optional. It will be selected according to subcrestal implant position. The cover screw 1 mm should flush with the bone surface in order to avoid bone growth over the cover screw.

In cases of tilted bone surface the Cover screw 2 mm might be used in exceptional cases where some areas of the implant shoulder lie deeper than 1 mm.

The forming of the bone is influenced in the shape of the beginning emergence profile of the abutment and so minimally the space needed at a later time for the abutment is ensured.

Suturing

The alveolar ridge is closed by sutures to prevent ingress of saliva. The sutures must be under as little tension as possible. The implant site is documented by a postoperative x-ray image. The implant must not be loaded during the healing phase.

Step-by-step: Immediate restoration with short-term temporary denture

In case the clinical preconditions for immediate restoration with a short-term temporary are favorable, your patient can benefit from the integration of an implant-supported restoration right after implant placement. A second surgical

procedure is not required, your patient sees a result immediately and you take optimum advantage of the regeneration potential of the soft tissue for creating a perfect emergence profile.

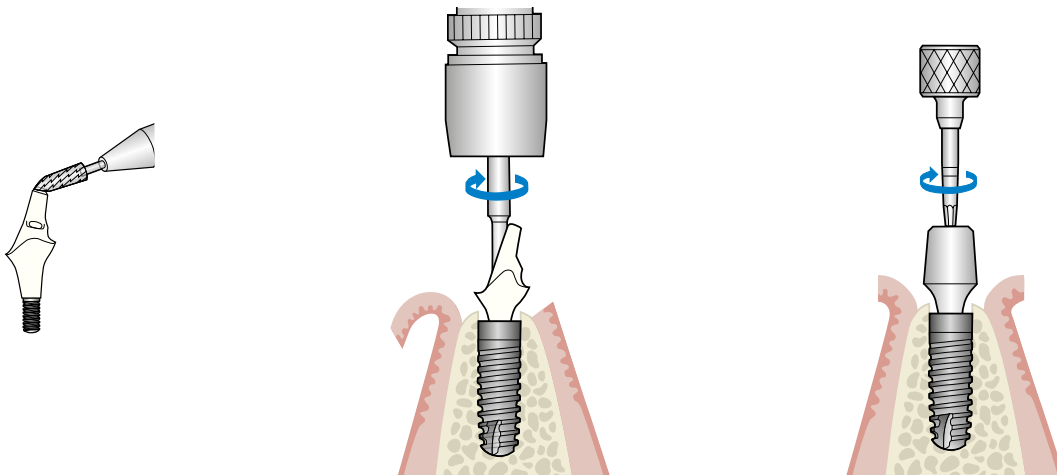

Short-term temporization

The temporary restoration is fabricated on the Ankylos Balance temporary abutment. The large Balance temporary abutment may be ground down maximally to the size of the small Balance temporary abutment. The small Balance temporary abutment must not be customized by grinding. For grinding, cross-toothed tungsten carbide cutters are used with up to 25.000 rpm. Grinding should be done outside of the mouth.

Delivery of short-term temporary

Clean and dry the taper connection of the implant with air/water spray prior to placing the abutment. The abutment is tightened using the 1 mm hexagon screwdriver with the prosthetic ratchet or a torque-controlled contra-angle hand-piece with 15 Ncm. The temporary suprastructure is cemented with provisional cement. Please remove all excess cement at the crown margin. Make sure tight suturing to prevent ingress of saliva.

Immediate loading with SynCone

There is the option of fabricating an immediately loaded prosthesis on prefabricated SynCone C/ tapered crowns on no fewer than four Ankylos implants placed interforaminally in the mandible

For details please see the SynCone manual.

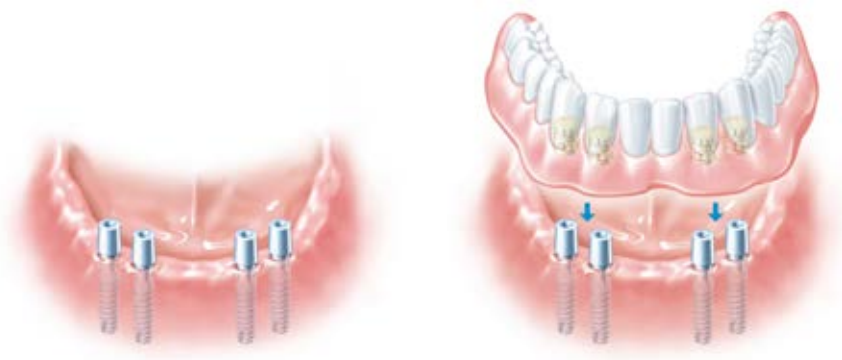
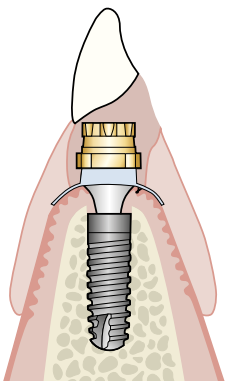

Short-term temporaries must be replaced after 6 months latest.

Step-by-step: Minimally invasive uncover

The implants are uncovered generally after three to four months in submerged healing. The great advantage of the tapered connection becomes evident in this step. The horizontal offset of the implant-abutment connection towards central makes it possible to open the gingiva with a minimally

invasive procedure without extended flap debridement. The procedure should be as atraumatic as possible to ensure that as little hard and soft tissue around the implant as possible is lost.

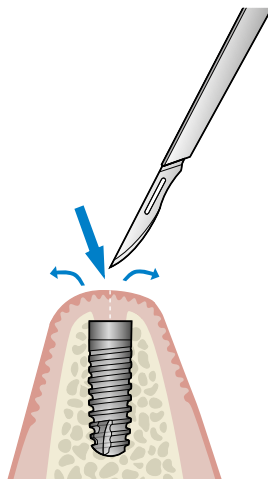

Incision

Locating the implants may be facilitated by again using the drill guide.

After locating the implant and local anesthesia directly above the implant (e.g. intraligamentary system), make a limited crestal incision on the implant surface.

In each case, finally use the gingiva/sulcus former suitable for the respective abutment. Only this will ensure the optimal contouring of the soft tissues and hence the required fit and stability for the prosthetic abutment. Gingiva/sulcus formers should be sterilized prior to use.

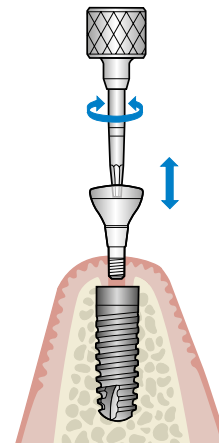
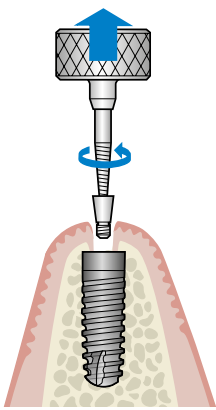

Removing the cover screw

The probe is replaced with the unscrew instrument. Insert the unscrew instrument for cover screws into the large 12 mm diameter handle for screwdriver and screw it counterclockwise into the internal thread of the cover screw under light pressure. The unscrew instrument grips the internal thread of the cover screw and screws it out.

This prepares the implant for fitting the gingiva-forming components. To remove the cover screw from the unscrew instrument the cover screw is clamped extraorally in the back of tweezers or the needle holder or gripped with pliers. Then the unscrew instrument is rotated clockwise until it comes away from the cover screw.

Placing gingiva former

The appropriate gingiva-forming component (gingiva former C/X, sulcus former) is selected depending on the selected prosthetic restoration. All gingiva formers are available in different geometries for an optimum fit with the anatomical conditions. After selection of the correct component it is placed in the implant and screwed into the internal thread of the implant with the screwdriver insert 1.0 mm hex fixed in the handle. The gingiva formers remain in situ for about two weeks.

Options for surgery

Indication

Implant site in the maxilla with sufficient vertical bone volume and retained cancellous intermediate zone between labial and palatal cortical lamella. The dentist with surgical experience can achieve excellent predictable results with this technique. It is important to note that the procedure described is not suitable for increasing the vertical bone volume.

Incision direction and flap design

The incision direction is offset in the palatal direction. In the labial direction the periosteum is not debrided to retain the vascular supply of the cortical bone lamella.

Marking the alveolar ridge

The center of the alveolar ridge is marked with a strong scalpel blade to define the plane in which the two cortical lamellae will be separated from each other. The exact position for the osteotomy is selected with the position marker.

Ankylos® BoneExpander and BoneCondenser

If the horizontal bone volume is reduced the implant site can be expanded by bone expansion and bone condensation, making additional augmentation procedures unnecessary. Permanent esthetic results are achieved by reconstruction of the resorbed labial bone wall.

Ankylos® BoneExpander

The D-shaped cross-section of the instrument is ideal for separating the labial and palatal bone lamellae and placing the implants in a single session. The labial and palatal cortical lamellae are separated with the BoneExpanders using a surgical mallet with controlled application of force. The instruments are used in four widths in increasing order of width to separate the cortical bone lamellae evenly and carefully. The convex surface of the D-shaped profile of the instrument points to the labial side, while the flat side of the instrument supports the palatal bone lamella to prevent extreme tension in the region of the labial cortical bone lamella.

Ankylos® BoneCondenser

The rounded cross-section is designed for the lengths and diameters of Ankylos implants. The bone shaping starts using controlled application of force, with a surgical mallet if necessary, with the position marker, followed by the Pilot BoneCondenser. Then, depending on the desired implant diameter, the three BoneCondensers are used in ascending size and the rounded profiles form the bone cavity for the desired implant diameter. In soft bone implants of diameters 3.5, 4.5 and 5.5 mm can be placed without requiring the use of a tap. The BoneCondensers can also be used for an internal sinus lift.

Healing phase

The provisional restoration of the patient is adjusted to the increased volume of the expanded alveolar ridge.

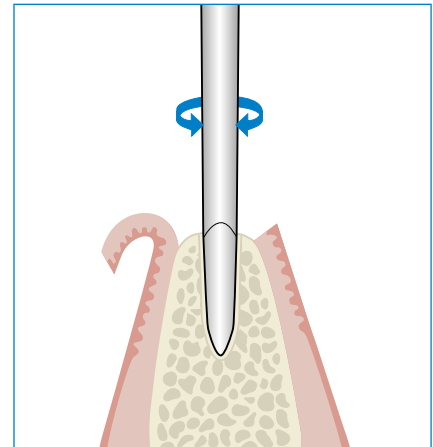
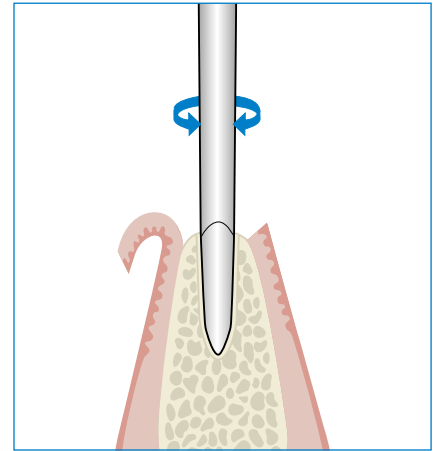

There must be absolutely no mechanical irritation or pressure on the soft tissue. The healing phase should be extended to six months.

Ankylos[®] sinuslift instruments

The Ankylos sinus lift instruments are based on the many years of practical experience with the sinus lift technique. A series of seven instruments with double ends makes selection and the surgical procedure easy for the surgeon. The hollow handles make the instruments very light and they are ergonomically designed. They are comfortable to hold and allow sensitive handling. Use the sharp working tips to lift the sinus mucosa carefully. All instruments are numbered on the handle and laid out logically in a surgical tray.

Surgical procedure

Appropriate training with practical exercises is essential for safe handling of the instruments. The following notes on the use of the instruments are guidelines only.

The instruments are selected so the tip of the instrument follows the floor of the maxillary sinus. This makes it easy to separate the sinus mucosa cleanly without perforation.

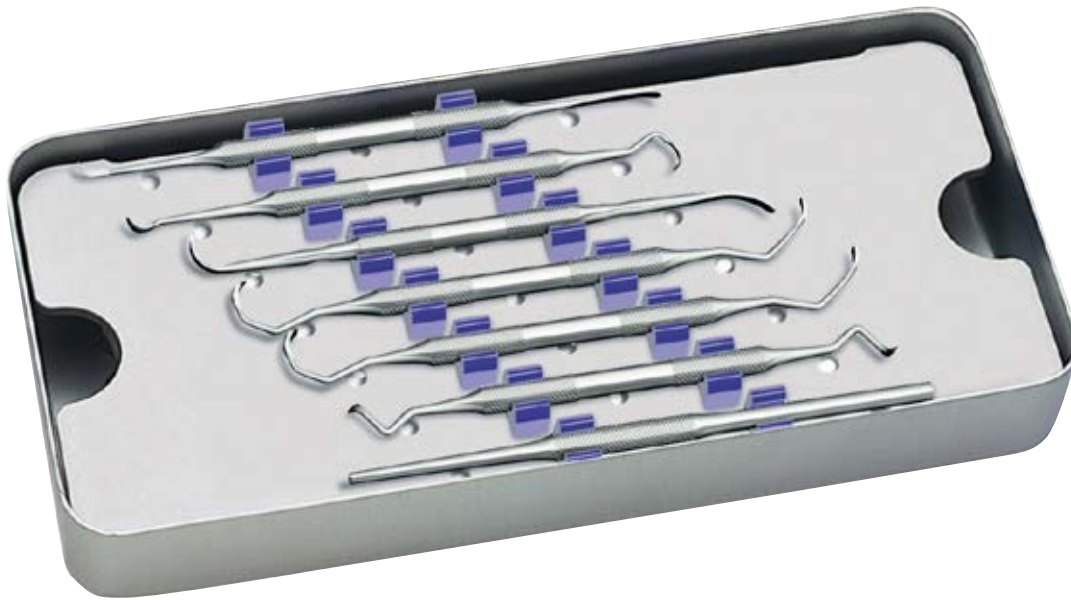

Instrument 1

- For flap debridement
- Sharp claw for mobilization of the interdental papillae
- Flat side for accurate lifting of the periosteum

Instrument 2

- For flap debridement
- Curved curette (180 degree) for flap debridement in inaccessible palatal sections, preparation of bone septa and for starting preparation of the maxillary sinus membrane
- Plate curette for universal application and for lifting the periosteal membrane

Instrument 3

- 180-degree curved side for mobilizing the sinus mucosa in the anterior region of the window and the floor of the maxillary sinus
- 45-degree curved side for mobilizing the sinus mucosa from the distal wall of the maxillary sinus and side wall of the nose. Also for removal of granular material

Instrument 4

- Narrow tips for unhindered access even in narrow regions
- Single curved tips (90 degrees) for access along the floor of the maxillary sinus during distal preparation
- Double curved tips (180 degrees) for mobilizing the sinus mucosa mesial from the window and on the floor of the maxillary sinus

Instrument 5

- Like instrument 4 but with wider tips
- Can also be used to protect the sinus mucosa during simultaneous implant placement

Instrument 6

- One end curved right and the other end curved left
- For access to the mesial, distal, superior and inferior regions at the margin of the bone window
- For continuing preparation of the sinus mucosa and for preparation of bone septa

Instrument 7

- Riffled ends of different diameters for folding in the bone window that was previously prepared with a round drill
- Narrower end for point use at the margin of the window, wider end for the center
- Recommended for use with a 300 g mallet; a mallet with a riffled working surface is optionally available

Postoperative care

The same treatment as after surgical closure of an oral-antro connection (MAV) is indicated. Nose-blowing must be avoided until removal of the sutures. Nose drops to reduce swelling are recommended. Oral hygiene can be maintained in the first seven to ten days after the operation by rinsing the mouth with a suitable oral antiseptic solution. Mechanical loads on the implant region must be avoided after the operation.

Ankylos[®] membrane screws

Extra-flat membrane screws can be used to fix the membrane when using the GBR technique. They are screwed into the thread of the cover screw of the closed implant. In this case the implant should not be placed subcrestally.



Four membrane screws are available:

Ø 3.5 mm:

For fixing the membranes on all implant diameters:

- use with the screwdriver insert 1.6 mm blade

Ø 6.0 mm:

For fixing membranes with improved shielding effect:

- also after single-stage sinus lift for additional securing of A-implants
- use with the screwdriver insert 1.6 mm blade

Ø 6.0 mm:

Two membrane screws for sinus lift:

- Cylinder of 1 or 2 mm between thread and screw face for fastening implants to osteosynthesis plates after single-session sinus lift
- Use with 1.0 mm hexagon screwdriver

About Dentsply Sirona Implants

Dentsply Sirona Implants offers comprehensive solutions for all phases of implant therapy, including Ankylos®, Astra Tech Implant System® and Xive® implant lines, digital technologies, such as Atlantis® patient-specific solutions and Simplant® guided surgery, Symbios® regenerative solutions, and professional and business development programs, such as STEPPS™. Dentsply Sirona Implants creates value for dental professionals and allows for predictable and lasting implant treatment outcomes, resulting in enhanced quality of life for patients.

About Dentsply Sirona

Dentsply Sirona is the world's largest manufacturer of professional dental products and technologies, with a 130-year history of innovation and service to the dental industry and patients worldwide. Dentsply Sirona develops, manufactures, and markets a comprehensive solutions offering including dental and oral health products as well as other consumable medical devices under a strong portfolio of world class brands. As The Dental Solutions Company™, Dentsply Sirona's products provide innovative, high-quality and effective solutions to advance patient care and deliver better, safer and faster dentistry. Dentsply Sirona's global headquarters is located in York, Pennsylvania, and the international headquarters is based in Salzburg, Austria. The company's shares are listed in the United States on NASDAQ under the symbol XRAY.

Visit www.dentsplysirona.com for more information about Dentsply Sirona and its products.